

OPTIDRIVE™

Stock Drives Catalogue

Variable Speed Drives
& Accessories





UK Headquarters, Welshpool

Inverter Drives

Inverter Drives is dedicated to the design and manufacture of sophisticated electronic variable speed drives, used to control motors in a wide variety of industrial and energy saving applications.



The Organisation

State of the art UK headquarters house specialist facilities for innovation, manufacturing and global marketing.

The company pledges to implement and operate the ISO 14001 Environmental Management System to enhance environmental performance.

All operations, including innovation, are accredited to the exacting customer focused ISO 9001 quality standard.

The company's products are sold globally by a network of specialist distributors in over 80 different countries. Inverter Drives' unique and innovative Optidrive range is designed for ease of use and meets recognised international design standards for CE (Europe), UL (USA) and RCM (Australia).





Innovative Products

- Easy to use variable speed drives
- Incredible performance
- Robust & reliable
- Low cost of installation & ownership
- Wide power range
0.37–250kW, 115V–600V



Company Overview



-  Inverter Office
-  Sales Partner
-  Service Centre

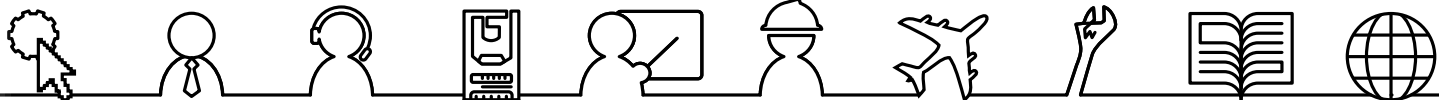

- Online Support
- Pre-sales Support
- Customer Service
- Technical Support
- Knowledge Management
- Field Service
- Logistics & Distribution
- Spare Parts & Repair
- Service Contracts
- International Support



- Conveyors
- HVAC
- Machine Tools



- Manufacturing
- Pumping
- Process Control



- Elevators
- Cranes

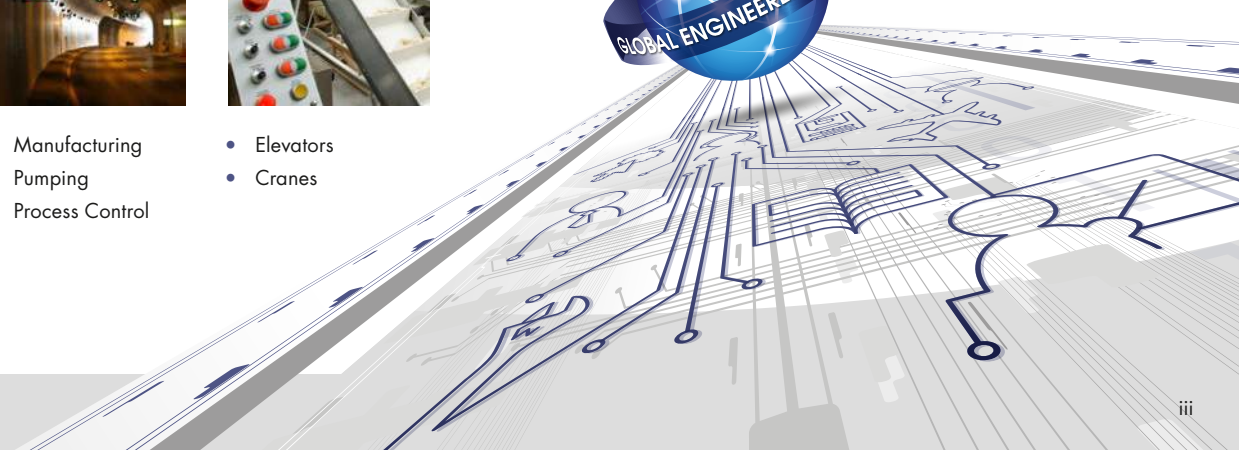

OPTIDRIVE™

AC Variable Speed Drives



P2

Pages 2-7

Page AC Variable Speed Drives

2 **OPTIDRIVE P2**

8 **OPTIDRIVE E3**

12 **OPTIDRIVE E3** Single Phase

14 **OPTIDRIVE Eco**

Options

22 **Keypads & Displays**

23 **Plug-in Options**

24 **Software / Commissioning**

25 **Networking Options**

26 **Input Chokes**

27 **Output Chokes**

28 **EMC Filters**

29 **Brake Resistors**

30 **Local Isolator**

30 **Through Hole Mount Kits**

31 **Options Compatibility**



Easy to use,
reliable products
with incredible
performance

Global service and
support network
leading edge design
& technology



Member of Sumitomo Drive Technologies



Motor Types	3 Phase Induction Motor (IM) Permanent Magnet AC Motor (PM) Brushless DC Motor (BLDC) Synchronous Reluctance Motor (SynRM)	
Typical Applications	General Industrial Fans Pumps Crane & Hoist	
Input Ratings	Supply Voltage	200 – 240 Volts ± 10% 380 – 480 Volts ± 10% 500 – 600 Volts ± 10%
Output Ratings	Output Power	230 Volt 1 Phase Input : Up to 10.5A / 2.2kW / 3HP 230 Volt 3 Phase Input : Up to 248A / 75kW / 100HP 400 Volt 3 Phase Input : Up to 480A / 250kW / 400HP 460 Volt 3 Phase Input : Up to 480A / 250kW / 400HP 575 Volt 3 Phase Input : Up to 150A / 110kW / 150HP
	Overload Capacity	150% for 60 Seconds 200% for 4 seconds
Ambient Conditions	Temperature	-10 – 50°C
Enclosure	Humidity	95% Max, non condensing
	Ingress Protection	IP20, IP55, IP66
Programming	Keypad	Built-in Keypad as standard Optional remote mountable keypad
	Display	Built-in multi language text display
Control Specification	Control Method	V/F Control Energy Optimised V/F 3GV Sensorless Vector Speed Control 3GV Sensorless Vector Torque Control Closed Loop [Encoder] Speed Control Closed Loop [Encoder] Torque Control PM Vector Control BLDC Control Synchronous Reluctance Motor Control
	PWM Frequency	4 – 32kHz Effective
Braking	Motor Flux Braking	
	Built-in Braking Transistor	
Setpoint Control	Analog Signal	0 to 10 Volts 10 to 0 Volts .10 to + 10 Volts 0 to 20mA 20 to 0mA 4 to 20mA 20 to 4 mA
	Digital	Motorised Potentiometer (Keypad) Modbus RTU CANopen
Fieldbus Connectivity	Built In	CANopen 125 – 1000kbps Modbus RTU 9.6 – 115.2 kbps selectable 8N1, 8N2, 8E1, 8O1
	Optional	PROFIBUS DP (DPV1) PROFINET IO DeviceNet EtherNet/IP EtherCat Modbus TCP
I/O Specification	Programmable Inputs	5 Total as standard (Optional additional 3) 3 Digital (Optional additional 3) 2 Analog / Digital Selectable
	Digital Inputs	8 – 30 Volt DC, internal or external supply Response time < 4ms
	Analog Inputs	Resolution : 12 bits Response time : < 4ms Accuracy : <1% full scale Parameter adjustable scaling and offset
	Programmable Outputs	4 Total (Optional additional 3) 2 Analog / Digital 2 Relays (Optional additional 3)
	Relay Outputs	Maximum Voltage : 250 VAC, 30 VDC Switching Current Capacity : 6A AC, 5A DC
	Analog Outputs	0 to 10 Volt 0 to 20mA 4 to 20mA
Application Features	PI(D) Control	Internal PID Controller Multi Setpoint Select Standby / Sleep Mode Boost Function
	Fire Mode	
	Load Monitoring	
	Duty / Assist / Standby	
	Hoist Mode	Dedicated Hoist Mode Motor Holding Brake Pre-Torque & Control Over Limit Protection
	Pump Blockage Detection	
	Pump Cleaning	
	Multi-pump control	
	Pump Stir	



E3 (3ph Out)	Pages 8-11	E3 (1ph Out)	Pages 12-13
		Eco	Pages 14-19

3 Phase Induction Motor (IM) Permanent Magnet AC Motor (PM) Brushless DC Motor (BLDC) Synchronous Reluctance Motor (SynRM)	Single Phase AC Motor Permanent Split Capacitor (PSC) Shaded Pole	3 Phase Induction Motor (IM) Permanent Magnet AC Motor (PM) Brushless DC Motor (BLDC) Synchronous Reluctance Motor (SynRM)
General Industrial Fans Pumps	General Industrial Fans Pumps	Fans Pumps

110 – 115 Volts ± 10% 200 – 240 Volts ± 10% 380 – 480 Volts ± 10%	110 – 115 Volts ± 10% 200 – 240 Volts ± 10%	200 – 240 Volts ± 10% 380 – 480 Volts ± 10% 500 – 600 Volts ± 10%
110 Volt 1 Phase Input : Up to 5.8A / 1.1kW / 1.5HP 230 Volt 1 Phase Input : Up to 15.3A / 4kW / 5HP 230 Volt 3 Phase Input : Up to 18A / 18.5kW / 25HP 400 Volt 3 Phase Input : Up to 46A / 37kW / 50HP 460 Volt 3 Phase Input : Up to 46A / 37kW / 50HP	110 Volt 1 Phase Input : Up to 10.5A / 0.55kW / 0.75HP 230 Volt 1 Phase Input : Up to 10.5A / 1.1kW / 1.5HP	230 Volt 1 Phase Input : Up to 10.5A / 2.2kW / 3HP 230 Volt 3 Phase Input : Up to 248A / 75kW / 100HP 400 Volt 3 Phase Input : Up to 480A / 250kW / 400HP 460 Volt 3 Phase Input : Up to 480A / 250kW / 400HP 575 Volt 3 Phase Input : Up to 150A / 110kW / 150HP
150% for 60 Seconds 175% for 2.5 seconds -20 – 50°C 95% Max, non condensing IP20, IP66 Built-in Keypad as standard Optional remote mountable keypad	150% for 60 Seconds 175% for 2.5 seconds -20 – 50°C 95% Max, non condensing IP20, IP66 Built-in Keypad as standard Optional remote mountable keypad	110% for 60 seconds 150% for 15 seconds -10 – 50°C 95% Max, non condensing IP20, IP55, IP66 Built-in Keypad as standard Optional remote mountable keypad
7 Segment LED	7 Segment LED	Built-in multi language text display
V/F Control Energy Optimised V/F Sensorless Vector Speed Control PM Vector Control BLDC Control Synchronous Reluctance Motor Control	V/F Voltage Vector Energy Optimised V/F	Eco Sensorless Vector Control Open Loop Permanent Magnet Vector Open Loop BLDC Vector Open Loop Synchronous Reluctance Vector
4 – 32kHz Effective	4 – 32kHz Effective	4 - 32kHz Effective
Motor Flux Braking Built-in Braking Transistor (Not Frame Size 1)	Motor Flux Braking Built-in Braking Transistor (Frame Size 2)	Motor Flux Braking

Analog Signal 0 to 10 Volts 10 to 0 Volts 0 to 20mA 20 to 0mA 4 to 20mA 20 to 4 mA	Analog Signal 0 to 10 Volts 10 to 0 Volts 0 to 20mA 20 to 0mA 4 to 20mA 20 to 4 mA	Analog Signal 0 to 10 Volts 10 to 0 Volts -10 to + 10 Volts 0 to 20mA 20 to 0mA 4 to 20mA 20 to 4 mA
Digital Motorised Potentiometer (Keypad) Modbus RTU CANopen	Digital Motorised Potentiometer (Keypad) Modbus RTU CANopen	Digital Motorised Potentiometer (Keypad) Modbus RTU BACnet MS/TP
CANopen 125 – 1000kbps	CANopen 125 – 1000kbps	BACnet MS/ TP BACnet Application Specific Controller 9.6 – 76.8 kbps selectable Data Format : 8N1, 8N2, 8E1, 8O1
Modbus RTU 9.6 – 115.2 kbps selectable	Modbus RTU 9.6 – 115.2 kbps selectable	Modbus RTU 9.6 – 115.2 kbps selectable 8N1, 8N2, 8E1, 8O1
		BACnet/IP Plug-in BACnet/IP Interface Dual LAN Ports Device Level Ring
		Other PROFIBUS DP (DPV1) PROFINET IO DeviceNet EtherNet/IP EtherCat Modbus TCP
4 Total 2 Digital 2 Analog / Digital Selectable 8 – 30 Volt DC, internal or external supply Response time < 4ms Resolution : 12 bits Response time : < 4ms Accuracy : ± 2% full scale Parameter adjustable scaling and offset	4 Total 2 Digital 2 Analog / Digital Selectable 8 – 30 Volt DC, internal or external supply Response time < 4ms Resolution : 12 bits Response time : < 4ms Accuracy : ± 2% full scale Parameter adjustable scaling and offset	5 Total as standard (Optional additional 3) 3 Digital (Optional additional 3) 2 Analog / Digital Selectable 8 – 30 Volt DC, internal or external supply Response time < 4ms Resolution : 12 bits Response time : < 4ms Accuracy : <1% full scale Parameter adjustable scaling and offset
2 Total 1 Analog / Digital 1 Relay Maximum Voltage : 250 VAC, 30 VDC Switching Current Capacity : 6A AC, 5A DC	2 Total 1 Analog / Digital 1 Relay Maximum Voltage : 250 VAC, 30 VDC Switching Current Capacity : 6A AC, 5A DC	4 Total (Optional additional 3) 2 Analog / Digital 2 Relays (Optional additional 3) Maximum Voltage : 250 VAC, 30 VDC Switching Current Capacity : 6A AC, 5A DC
0 to 10 Volt	0 to 10 Volt	0 to 10 Volt 0 to 20mA 4 to 20mA
Internal PI Controller Standby / Sleep Function	Internal PI Controller Standby / Sleep Function	Internal PID Controller Multi Setpoint Select Standby / Sleep Mode Boost Function
Bidirectional Selectable Speed Setpoint (Fixed / PID / Analog / Fieldbus)	Selectable Speed Setpoint (Fixed / PID / Analog / Fieldbus)	Bidirectional Selectable Speed Setpoint (Fixed / PID / Analog / Fieldbus) Over Torque Protection (Fan / Pump Blocked) Under Torque Protection (Broken Belt / Shaft) Pump Blockage Detection with Cleaning Built-in Multi Pump Support Automatic Changeover on Fault Automatic Changeover on Run Time Fully Redundant
		Pump load monitoring with autotune function, user configurable
		Adjustable Bidirectional Pump Cleaning Cycle operation
		Control of fixed speed assist pumps (with cascade control module)
		Control of Duty, Assist and Standby variable speed pumps via internal Master – Slave network
		Automatic pump stir function

OPTIDRIVE™ CP²

AC Variable Speed Drive

0.75 – 250kW / 1 – 400HP
200 – 600V Single & 3 Phase Input

World Leading Motor Control

Controlling the latest generation of permanent magnet motors and standard induction motors

Optidrive P2 offers the perfect combination of high performance together with ease of use to allow even the most demanding applications to be tackled easily.

- Low ambient operation (-10°C)
- Dedicated Hoist Mode
- CAN and Modbus RTU communication as standard

High Performance

Sensorless Vector Control

Up to 200% torque from zero speed ensures reliable starting and accurate speed control under all load conditions.

PM Motor Control

Future proof. Allows upgrade to the latest generation of high efficiency permanent magnet motors.

I/O & Communications

Optidrive P2 supports a wide range of interfaces to machine control systems.

Low Cost Installation

Built-in EMC Filter

An internal filter in every Optidrive P2 saves cost and time for installation.

Integral Brake Transistor

Saves space, cost and time for installation.

Powerful PC based commissioning software

OptiTools Studio

OptiTools Studio allows parameter upload, download and storage and access to Optidrive P2 Simple PLC functionality.

See Page 24

OPTISTICK Smart

OPT-3-STICK-IN



NFC

Bluetooth®

- Allows copying, backup and restore of drive parameters
- Provides Bluetooth interface to a PC running OptiTools Studio or the OptiTools Mobile app on a smartphone
- Onboard NFC (Near Field Communication) for rapid data transfer



IP55 / NEMA 12

Up to 250kW



IP66 / NEMA 4X

Up to 22kW

Manufacturing Conveyor Systems Plastics Processing Plants Chemical
Pumping Machine Tools Rubber Elevators Cranes

150% overload for 60 seconds
200% overload for 4 seconds
Industrial heavy duty rating for every model

Multi Language
Text Display



DIN Rail Mount
(IP20)



Pluggable Terminals



High Quality
Long-life Fans



High Performance | Easy to Use

Simple PLC Functionality

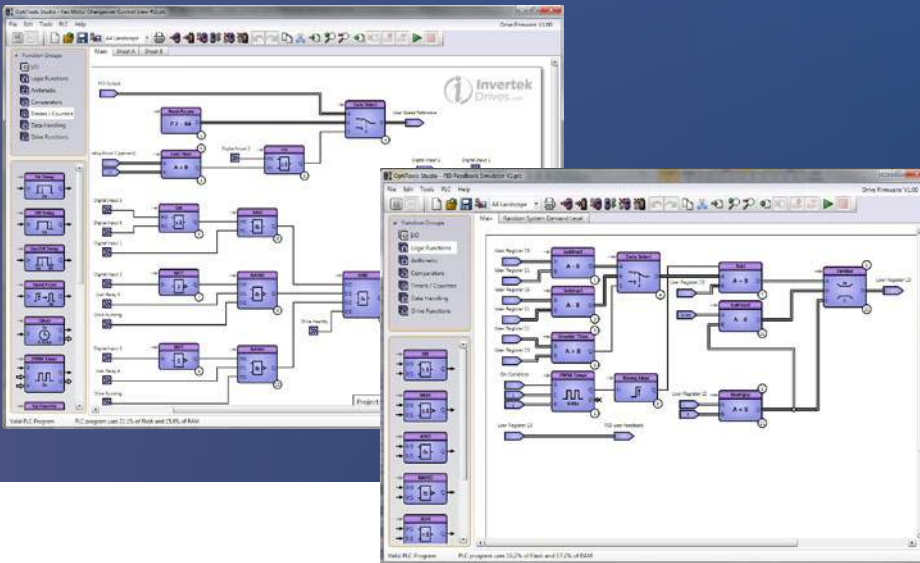

A wide range of function types available including:

- Programmable Logic Functions
- Comparators
- Timers
- Mathematical Functions
- Drive specific functions

All blocks can be easily combined to create flexible programs.

Programs can be protected to prevent unauthorised copying.

Complete control over the drive including all inputs and outputs.

Safe Torque Off (provided as standard)

Optidrive P2 features a safe torque off function to allow simple integration into machine critical safety circuits.

- Simple machine design reduces component costs, saves panel space and minimises installation time
- Faster shut down and reset procedures reduce system maintenance time
- Better safety standard compared to mechanical solution
- Better motor connection. Single cable with no interruption.



With

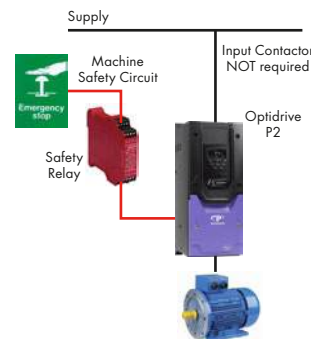

Without

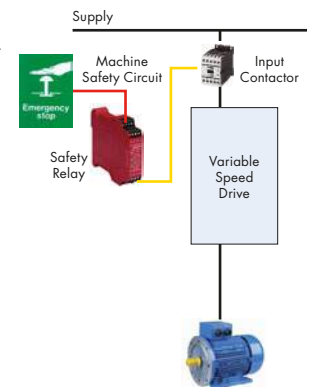

IP20

Up to 250kW

IP55

Up to 250kW

IP66

Up to 22kW

Advanced Motor Control

Optidrive P2 has been uniquely developed to allow a wide range of different motor types to be used, with only parameter changes being required. This technology allows the same drive to be used in a wide range of applications, allowing OEMs and end user alike to take advantage of the energy saving provided by using the latest motor technologies.

AC Induction Motors

The majority of AC motors in use today around the world are standard induction motors. These motors are relatively low cost, readily available and provide good performance with long service life. With the ever increasing focus on energy efficiency, motor manufacturers have refined and improved their designs in recent years.

Optidrive P2 has been developed to provide optimum control and maximum efficiency when operating with older motors designs, or newer high efficiency designs.

Operation can be in simple V/F control mode or in High Performance Third Generation Vector Mode, which provides up to 200% torque from zero speed without requiring an encoder.

Permanent Magnet AC Motors

Permanent magnet AC motors provide improved efficiency compared to standard induction motors. Using permanent magnets in the motor construction eliminates the need for any magnetising current, reducing electrical losses. PM motors have been used for many years in high performance applications, however this has always required the use of a feedback device, such as a resolver or encoder. Optidrive P2 has been designed to operate with AC PM motors without requiring any feedback device, allowing them to be used for their energy efficiency benefits without incurring extra cost and complexity in applications which do not require position feedback.

Brushless DC Motors

BLDC motors are similar to AC PM motors, however the design requires a slightly different control method to optimise the performance. Optidrive P2 has the flexibility to control this type of motor, requiring only simple parameter changes. This provides much greater flexibility for OEMs, allowing Optidrive P2 to be used in a variety of applications, with various motor types.

Synchronous Reluctance Motors

Synchronous Reluctance Motors (SynRM), not to be confused with Switched Reluctance Motors, share a similar stator construction to standard induction motors, however the rotor is substantially different, in order to improve the overall efficiency of the motor. SynRM motors are ideally suited to variable torque applications.

Optidrive P2 can control synchronous reluctance motors, allowing the energy saving benefits to be realised.

Replace # in model code with enclosure/display option

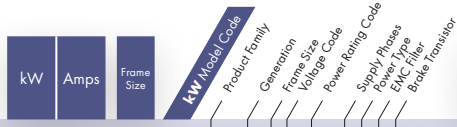

	kW	Amps	Frame Size	kW Model Code	Product Family	Generation	Frame Size	Voltage Code	Power Rating Code	Supply Phases	Power Type	EMC Filter	Brake Transistor	IP20 Cabinet Mount	IP55 TFT Display	Indoor IP66 Non Switched	Indoor IP66 Switched	Outdoor IP66 Non Switched	Outdoor IP66 Switched
200-240V ± 10% 1 Phase Input	0.75	4.3	2	ODP - 2 - 2 2 075 - 1	K	F	4	#	2-MN	X-TN	Y-TN	A-MN	B-MN						
	1.5	7	2	ODP - 2 - 2 2 150 - 1	K	F	4	#	2-MN	X-TN	Y-TN	A-MN	B-MN						
	2.2	10.5	2	ODP - 2 - 2 2 220 - 1	K	F	4	#	2-MN	X-TN	Y-TN	A-MN	B-MN						
200-240V ± 10% 3 Phase Input	0.75	4.3	2	ODP - 2 - 2 2 075 - 3	K	F	4	#	2-MN	X-TN	Y-TN	A-MN	B-MN						
	1.5	7	2	ODP - 2 - 2 2 150 - 3	K	F	4	#	2-MN	X-TN	Y-TN	A-MN	B-MN						
	2.2	10.5	2	ODP - 2 - 2 2 220 - 3	K	F	4	#	2-MN	X-TN	Y-TN	A-MN	B-MN						
	4	18	3	ODP - 2 - 3 2 040 - 3	K	F	4	#	2-MN	X-TN	Y-TN	A-MN	B-MN						
	5.5	24	3	ODP - 2 - 3 2 055 - 3	K	F	4	#	2-MN	X-TN	Y-TN	A-MN	B-MN						
	5.5	24	4	ODP - 2 - 4 2 055 - 3	K	F	4	#	2-MN	X-TN	Y-TN	A-MN	B-MN						
	7.5	30	4	ODP - 2 - 4 2 075 - 3	K	F	4	#	2-MN	X-TN	Y-TN	A-MN	B-MN						
	11	46	4	ODP - 2 - 4 2 110 - 3	K	F	4	#	2-MN	X-TN	Y-TN	A-MN	B-MN						
	15	60	5	ODP - 2 - 5 2 150 - 3	K	F	4	#	2-MN	X-TN	Y-TN	A-MN	B-MN						
	18.5	72	5	ODP - 2 - 5 2 185 - 3	K	F	4	#	2-MN	X-TN	Y-TN	A-MN	B-MN						
	22	90	6	ODP - 2 - 6 2 022 - 3	K	F	4	#	2-MN	X-TN	Y-TN	A-MN	B-MN						
	22	90	6A	ODP - 2 - 6 2 022 - 3	K	F	4	#	2-MN	X-TN	Y-TN	A-MN	B-MN						
	30	110	6	ODP - 2 - 6 2 030 - 3	K	F	4	#	2-MN	X-TN	Y-TN	A-MN	B-MN						
	30	110	6A	ODP - 2 - 6 2 030 - 3	K	F	4	#	2-MN	X-TN	Y-TN	A-MN	B-MN						
	37	150	6	ODP - 2 - 6 2 037 - 3	K	F	4	#	2-MN	X-TN	Y-TN	A-MN	B-MN						
37	150	6B	ODP - 2 - 6 2 037 - 3	K	F	4	#	2-MN	X-TN	Y-TN	A-MN	B-MN							
45	180	6	ODP - 2 - 6 2 045 - 3	K	F	4	#	2-MN	X-TN	Y-TN	A-MN	B-MN							
45	180	6B	ODP - 2 - 6 2 045 - 3	K	F	4	#	2-MN	X-TN	Y-TN	A-MN	B-MN							
55	202	7	ODP - 2 - 7 2 055 - 3	K	F	4	#	2-MN	X-TN	Y-TN	A-MN	B-MN							
75	248	7	ODP - 2 - 7 2 075 - 3	K	F	4	#	2-MN	X-TN	Y-TN	A-MN	B-MN							
380-480V ± 10% 3 Phase Input	0.75	2.2	2	ODP - 2 - 2 4 075 - 3	K	F	4	#	2-MN	X-TN	Y-TN	A-MN	B-MN						
	1.5	4.1	2	ODP - 2 - 2 4 150 - 3	K	F	4	#	2-MN	X-TN	Y-TN	A-MN	B-MN						
	2.2	5.8	2	ODP - 2 - 2 4 220 - 3	K	F	4	#	2-MN	X-TN	Y-TN	A-MN	B-MN						
	4	9.5	2	ODP - 2 - 2 4 400 - 3	K	F	4	#	2-MN	X-TN	Y-TN	A-MN	B-MN						
	5.5	14	3	ODP - 2 - 3 4 055 - 3	K	F	4	#	2-MN	X-TN	Y-TN	A-MN	B-MN						
	7.5	18	3	ODP - 2 - 3 4 075 - 3	K	F	4	#	2-MN	X-TN	Y-TN	A-MN	B-MN						
	11	24	3	ODP - 2 - 3 4 110 - 3	K	F	4	#	2-MN	X-TN	Y-TN	A-MN	B-MN						
	11	24	4	ODP - 2 - 4 4 110 - 3	K	F	4	#	2-MN	X-TN	Y-TN	A-MN	B-MN						
	15	30	4	ODP - 2 - 4 4 150 - 3	K	F	4	#	2-MN	X-TN	Y-TN	A-MN	B-MN						
	18.5	39	4	ODP - 2 - 4 4 185 - 3	K	F	4	#	2-MN	X-TN	Y-TN	A-MN	B-MN						
	22	46	4	ODP - 2 - 4 4 220 - 3	K	F	4	#	2-MN	X-TN	Y-TN	A-MN	B-MN						
	30	61	5	ODP - 2 - 5 4 300 - 3	K	F	4	#	2-MN	X-TN	Y-TN	A-MN	B-MN						
	37	72	5	ODP - 2 - 5 4 370 - 3	K	F	4	#	2-MN	X-TN	Y-TN	A-MN	B-MN						
	45	90	6	ODP - 2 - 6 4 045 - 3	K	F	4	#	2-MN	X-TN	Y-TN	A-MN	B-MN						
	45	90	6A	ODP - 2 - 6 4 045 - 3	K	F	4	#	2-MN	X-TN	Y-TN	A-MN	B-MN						
55	110	6	ODP - 2 - 6 4 055 - 3	K	F	4	#	2-MN	X-TN	Y-TN	A-MN	B-MN							
55	110	6A	ODP - 2 - 6 4 055 - 3	K	F	4	#	2-MN	X-TN	Y-TN	A-MN	B-MN							
75	150	6	ODP - 2 - 6 4 075 - 3	K	F	4	#	2-MN	X-TN	Y-TN	A-MN	B-MN							
75	150	6B	ODP - 2 - 6 4 075 - 3	K	F	4	#	2-MN	X-TN	Y-TN	A-MN	B-MN							
90	180	6	ODP - 2 - 6 4 090 - 3	K	F	4	#	2-MN	X-TN	Y-TN	A-MN	B-MN							
90	180	6B	ODP - 2 - 6 4 090 - 3	K	F	4	#	2-MN	X-TN	Y-TN	A-MN	B-MN							
110	202	6B	ODP - 2 - 6 4 110 - 3	K	F	4	#	2-MN	X-TN	Y-TN	A-MN	B-MN							
110	202	7	ODP - 2 - 7 4 110 - 3	K	F	4	#	2-MN	X-TN	Y-TN	A-MN	B-MN							
132	240	7	ODP - 2 - 7 4 132 - 3	K	F	4	#	2-MN	X-TN	Y-TN	A-MN	B-MN							
160	302	7	ODP - 2 - 7 4 160 - 3	K	F	4	#	2-MN	X-TN	Y-TN	A-MN	B-MN							
200	370	8	ODP - 2 - 8 4 200 - 3	K	F	4	#	2-MN	X-TN	Y-TN	A-MN	B-MN							
250	480	8	ODP - 2 - 8 4 250 - 3	K	F	4	#	2-MN	X-TN	Y-TN	A-MN	B-MN							
480-525V ± 10% 3 Phase Input	132	185	7	ODP - 2 - 7 5 132 - 3	K	O	4	#	2-MN	X-TN	Y-TN	A-MN	B-MN						
	150	205	7	ODP - 2 - 7 5 150 - 3	K	O	4	#	2-MN	X-TN	Y-TN	A-MN	B-MN						
	185	255	7	ODP - 2 - 7 5 185 - 3	K	O	4	#	2-MN	X-TN	Y-TN	A-MN	B-MN						
	200	275	7	ODP - 2 - 7 5 200 - 3	K	O	4	#	2-MN	X-TN	Y-TN	A-MN	B-MN						
500-600V ± 10% 3 Phase Input	0.75	2.1	2	ODP - 2 - 2 6 075 - 3	K	O	4	#	2-MN	X-TN	Y-TN	A-MN	B-MN						
	1.5	3.1	2	ODP - 2 - 2 6 150 - 3	K	O	4	#	2-MN	X-TN	Y-TN	A-MN	B-MN						
	2.2	4.1	2	ODP - 2 - 2 6 220 - 3	K	O	4	#	2-MN	X-TN	Y-TN	A-MN	B-MN						
	4	6.5	2	ODP - 2 - 2 6 400 - 3	K	O	4	#	2-MN	X-TN	Y-TN	A-MN	B-MN						
	5.5	9	2	ODP - 2 - 2 6 550 - 3	K	O	4	#	2-MN	X-TN	Y-TN	A-MN	B-MN						
	7.5	12	3	ODP - 2 - 3 6 075 - 3	K	O	4	#	2-MN	X-TN	Y-TN	A-MN	B-MN						
	11	17	3	ODP - 2 - 3 6 110 - 3	K	O	4	#	2-MN	X-TN	Y-TN	A-MN	B-MN						
	15	22	3	ODP - 2 - 3 6 150 - 3	K	O	4	#	2-MN	X-TN	Y-TN	A-MN	B-MN						
	15	22	4	ODP - 2 - 4 6 150 - 3	K	O	4	#	2-MN	X-TN	Y-TN	A-MN	B-MN						
	18.5	28	4	ODP - 2 - 4 6 185 - 3	K	O	4	#	2-MN	X-TN	Y-TN	A-MN	B-MN						
	22	34	4	ODP - 2 - 4 6 220 - 3	K	O	4	#	2-MN	X-TN	Y-TN	A-MN	B-MN						
	30	43	4	ODP - 2 - 4 6 300 - 3	K	O	4	#	2-MN	X-TN	Y-TN	A-MN	B-MN						
	37	54	5	ODP - 2 - 5 6 370 - 3	K	O	4	#	2-MN	X-TN	Y-TN	A-MN	B-MN						
	45	65	5	ODP - 2 - 5 6 450 - 3	K	O	4	#	2-MN	X-TN	Y-TN	A-MN	B-MN						
	55	78	6	ODP - 2 - 6 6 055 - 3	K	O	4	#	2-MN	X-TN	Y-TN	A-MN	B-MN						
75	105	6	ODP - 2 - 6 6 075 - 3	K	O	4	#	2-MN	X-TN	Y-TN	A-MN	B-MN							
90	130	6	ODP - 2 - 6 6 090 - 3	K	O	4	#	2-MN	X-TN	Y-TN	A-MN	B-MN							
110	150	6	ODP - 2 - 6 6 110 - 3	K	O	4	#	2-MN	X-TN	Y-TN	A-MN	B-MN							

Model Code Guide

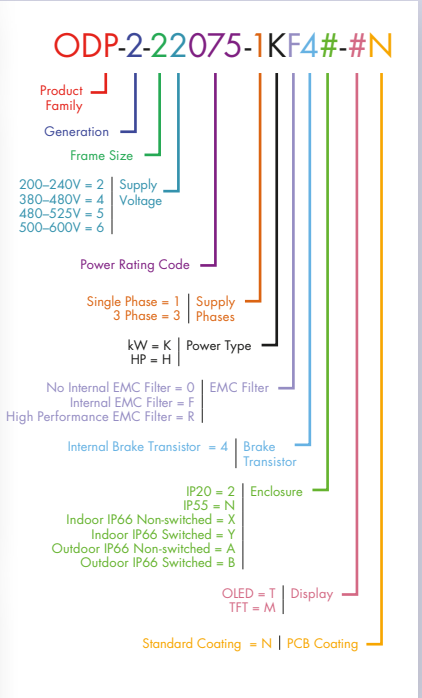

EMC Filter

- O** No Internal EMC Filter
- F** Internal EMC Filter
- R** High Performance EMC Filter

kW Models: Factory Settings
 Motor Rated Frequency: 50Hz
 Motor Rated Voltage: 230/400/575V

Drive Specification

Input Ratings	Supply Voltage	200 – 240V ± 10% 380 – 480V ± 10% 500 – 600V ± 10%	Fieldbus Connectivity	Builtin	CANopen	125 – 1000kbps	
	Supply Frequency	48 – 62Hz		Optional	Modbus RTU	9.6 - 115.2 kbps selectable 8N1, 8N2, 8E1, 8O1	
Output Ratings	Displacement Power Factor	> 0.98	I/O Specification	Optional	Other	PROFIBUS DP (DPV1) PROFINET IO DeviceNet EtherNet/IP EtherCAT Modbus TCP	
	Phase Imbalance	3% Maximum allowed			Power Supply	24 Volt DC, 100mA, Short Circuit Protected 10 Volt DC, 10mA for Potentiometer	
Ambient Conditions	Inrush Current	< rated current	Programmable Inputs	5 Total as standard (Optional additional 3) 3 Digital (Optional additional 3) 2 Analog / Digital Selectable 5 Digital With CAN IO Option	Digital Inputs	Opto- Isolated 8 – 30 Volt DC, internal or external supply Response time < 4ms	
	Power Cycles	120 per hour maximum, evenly spaced		Digital Inputs	Resolution: 12 bits Response time: < 4ms Accuracy: < 1% full scale Parameter adjustable scaling and offset	Analog Inputs	Motor PTC / Thermistor Input Trip Level : 2.5kΩ
Enclosure	Overload Capacity	150% for 60 seconds	Relay Outputs	7 Total (Optional additional 3) 2 Analog / Digital 2 Relays (Optional additional 3) 3 With CAN IO Option Module	Application Features	PID Control	Internal PID Controller Multi Setpoint Select Standby / Sleep Mode Boost Function
	Output Frequency	0 – 500Hz, 0.1Hz resolution		Analog Outputs		Maximum Voltage: 250 VAC, 30 VDC Switching Current Capacity: 5A AC, 5A DC	Hoist Mode
Programming	Acceleration Time	0.01 – 600 seconds	Analog Outputs	0 to 10 Volt 0 to 20mA 4 to 20mA	Maintenance & Diagnostics	Fault Memory	Last 4 Trips stored with time stamp
	Deceleration Time	0.01 – 600 seconds		Relay Outputs		0 to 10 Volt 0 to 20mA 4 to 20mA	Data Logging
Control Specification	Typical Efficiency	> 98%	Monitoring	Hours Run Meter Resettable & Non Resettable kWh meters Cooling Fan Run Time	Standards Compliance	Maintenance Indicator	Maintenance Indicator with user adjustable maintenance interval Onboard service life monitoring
	Temperature	Storage: –40 to 60°C Operating: –10 to 50°C		Standards Compliance		Low Voltage Directive	2014/35/EU
Enclosure	Altitude	Up to 1000m ASL without derating Up to 2000m maximum UL Approved Up to 4000m maximum (non UL)	Setpoint Control		Analog Signal	0 to 10 Volts 10 to 0 Volts –10 to +10 Volts 0 to 20mA 20 to 0mA 4 to 20mA 20 to 4mA PTC	EMC Directive
	Ingress Protection	IP20, IP55, IP66		Digital	Motorised Potentiometer (Keypad & Terminal) Modbus RTU CANopen	Additional Conformance	UL, cUL, EAC, RCM
Programming	Humidity	95% Max, non condensing	Digital	Motorised Potentiometer (Keypad & Terminal) Modbus RTU CANopen	Marine Certification	DNV Type Approval	
	Vibration	Conforms to IEC 60068-2-6 Sinusoidal Vibration 10 - 57Hz @ 0.075mm Pk 57 - 150Hz @ 1g Pk		Digital	Motorised Potentiometer (Keypad & Terminal) Modbus RTU CANopen	Environmental Conditions	Designed to meet IEC 60721-3-3, in operation: IP20 Drives: 3S2/3C2 IP55 & 66 Drives: 3S3/3C3

Connection Diagram

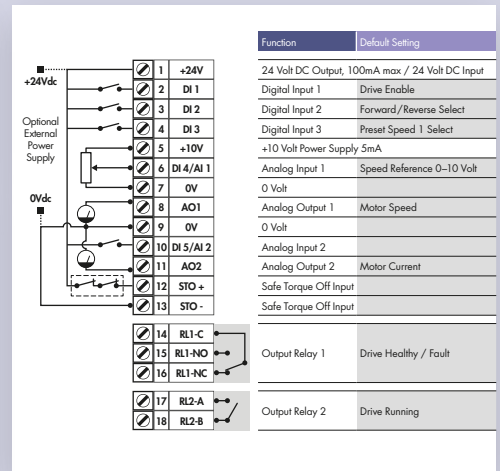

NOT TO SCALE



Size	IP20						IP66			IP55				
	2	3	4	5	6A	6B	2	3	4	4	5	6	7	8
mm Height	221	261	418	486	614	726	257	310	360	450	540	865	1280	1334
mm Width	110	131	172	233	286	330	188	211	240	171	235	330	330	444
mm Depth	185	205	240	260	320	320	172	235	271	252	270	332	358	423
kg Weight	1.8	3.5	9.2	18.1	32	43	3.5	6.6	9.5	11.5	23	55	89	TBC

OPTIDRIVE™

Easy to Use

General Purpose Drive

Focused on ease of use, **Optidrive E3** provides unrivalled simplicity of installation, connection and commissioning, allowing the user to benefit from precise motor control and energy savings within minutes.



Simple Commissioning

With just 14 basic parameters and application macro functions providing rapid set up, Optidrive E3 minimises start-up time.



Intuitive Keypad Control

Precise digital control at the touch of a button.



Application Macros

Switch between **Industrial**, **Pump & Fan** modes to optimise Optidrive E3 for your application.

Industrial | Pump | Fan

IP20

Compact, robust and reliable general purpose drive for panel mounting

Up to 37kW

- ✓ Easy to use
- ✓ Compact & robust



Take a closer look at the stunning Optidrive E3



www.invertekdrives.com/optidrive-e3

Sensorless Vector Control for all Motor Types

IM

IE2 & IE3 Induction Motors

PM

AC Permanent Magnet Motors

BLDC

Brushless DC Motors

SynRM

Synchronous Reluctance Motors

LSPM

Line Start PM Motor

Precise and reliable control for **E2, IE3, IE4 & IE5** motors

IP66 Outdoor

Up to 22kW

- ✓ Outdoor rated
- ✓ Dust-tight
- ✓ Washdown ready



Coated Heatsink as Standard

Ideal for hygiene based operations requiring washdown — such as food and beverage



IP66 / NEMA 4X



Key Features

- ✓ Internal Category C1 EMC filter
- ✓ Internal PI control
- ✓ Internal brake chopper
- ✓ Dual analogue inputs
- ✓ Operates up to 50°C
- ✓ Bluetooth connectivity
- ✓ Option for control of single phase motors

Modbus RTU
CAN

on-board as standard

Internal Category C1 EMC Filter

An internal filter in every Optidrive E3 saves cost and time for installation.

Cat C1 according to EN61800-3:2004



Application Macros

Switch modes at the touch of a button to optimise Optidrive E3 for your application

Single parameter application macro selection



Industrial Mode

Industrial Mode optimises Optidrive E3 for load characteristics of typical industrial applications.

Applications include:



- ✓ Conveyors
- ✓ Mixers
- ✓ Treadmills

Sensorless Vector provides high starting torque and excellent speed regulation

IP20 panel mount units or **IP66** for direct machine mounting



Rapid parameter cloning using **OPTISTICK**

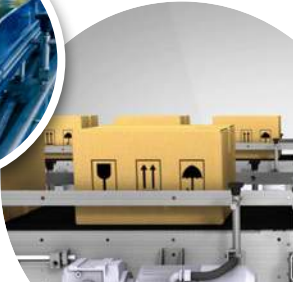

Pump Mode

Pump Mode makes energy efficient pump control easier than ever.

Applications include:

- ✓ Dosing Pumps
- ✓ Borehole Pumps
- ✓ Transfer Pumps
- ✓ Swimming Pools
- ✓ Spas
- ✓ Fountains

- Constant or variable torque
- Internal PI control

Fan Mode

Fan Mode (inc. fire operation) makes air handling a breeze, ideal for simple HVAC systems.

Applications include:

- ✓ Air Handling Units
- ✓ Ventilation Fans
- ✓ Circulating Fans
- ✓ Air Curtains
- ✓ Kitchen Extract



- High efficiency **variable torque** motor control
- Flying start capability
- Mains loss ride through
- PI control

Instant Power Savings

The graph below shows the incredible efficiency of Optidrive E3 for controlling airflow compared to traditional damper control methods.



Air Volume (%)	Outlet Damper (kW)	Inlet Damper (kW)	Optidrive E3 (kW)
0	0	0	0
20	55	35	5
40	75	50	15
60	90	65	30
80	95	80	50
100	100	100	100

Modbus RTU CAN

on-board as standard

How much energy could you save?

Estimate potential energy savings, CO₂ emissions and financial savings for your application with the Inverter Drives Energy Savings Calculator app.



www.invertekdrives.com/calculator

	kW	HP	Amps	Frame	Model Code	Product Family	Generation	Frame Size	Voltage Code	Output Current x 10	Supply Phases	EMC Filter	Brake Transistor	Enclosure Option
110–115V ± 10% 1 Phase Input	0.37	0.5	2.3	1	ODE - 3 - 1 1 0023 - 1	0	1	#						
	0.75	1	4.3	1	ODE - 3 - 1 1 0043 - 1	0	1	#						
	1.1	1.5	5.8	2	ODE - 3 - 2 1 0058 - 1	0	4	#						
200–240V ± 10% 1 Phase Input	0.37	0.5	2.3	1	ODE - 3 - 1 2 0023 - 1	#	1	#						
	0.75	1	4.3	1	ODE - 3 - 1 2 0043 - 1	#	1	#						
	1.5	2	7	1	ODE - 3 - 1 2 0070 - 1	#	1	#						
	1.5	2	7	2	ODE - 3 - 2 2 0070 - 1	#	4	#						
	2.2	3	10.5	2	ODE - 3 - 2 2 0105 - 1	#	4	#						
	4	5	15.3	3	ODE - 3 - 3 2 0153 - 1	0	4	#						
200–240V ± 10% 3 Phase Input	0.37	0.5	2.3	1	ODE - 3 - 1 2 0023 - 3	0	1	#						
	0.75	1	4.3	1	ODE - 3 - 1 2 0043 - 3	0	1	#						
	1.5	2	7	1	ODE - 3 - 1 2 0070 - 3	0	1	#						
	1.5	2	7	2	ODE - 3 - 2 2 0070 - 3	#	4	#						
	2.2	3	10.5	2	ODE - 3 - 2 2 0105 - 3	#	4	#						
	4	5	18	3	ODE - 3 - 3 2 0180 - 3	#	4	#						
	5.5	7.5	24	3	ODE - 3 - 3 2 0240 - 3	#	4	#						
	7.5	10	30	4	ODE - 3 - 4 2 0300 - 3	#	4	#						
	11	15	46	4	ODE - 3 - 4 2 0460 - 3	#	4	#						
	15	20	61	5	ODE - 3 - 5 2 0610 - 3	F	4	2						
18.5	25	72	5	ODE - 3 - 5 2 0720 - 3	F	4	2							
380–480V ± 10% 3 Phase Input	0.75	1	2.2	1	ODE - 3 - 1 4 0022 - 3	#	1	#						
	1.5	2	4.1	1	ODE - 3 - 1 4 0041 - 3	#	1	#						
	1.5	2	4.1	2	ODE - 3 - 2 4 0041 - 3	#	4	#						
	2.2	3	5.8	2	ODE - 3 - 2 4 0058 - 3	#	4	#						
	4	5	9.5	2	ODE - 3 - 2 4 0095 - 3	#	4	#						
	5.5	7.5	14	3	ODE - 3 - 3 4 0140 - 3	#	4	#						
	7.5	10	18	3	ODE - 3 - 3 4 0180 - 3	#	4	#						
	11	15	24	3	ODE - 3 - 3 4 0240 - 3	#	4	#						
	15	20	30	4	ODE - 3 - 4 4 0300 - 3	#	4	#						
	18.5	25	39	4	ODE - 3 - 4 4 0390 - 3	#	4	#						
	22	30	46	4	ODE - 3 - 4 4 0460 - 3	#	4	#						
	30	40	61	5	ODE - 3 - 5 4 0610 - 3	F	4	2						
37	50	72	5	ODE - 3 - 5 4 0720 - 3	F	4	2							

Replace # in model code with colour-coded option

Enclosure Types

A  **IP66 Outdoor Use Non-switched**

B  **IP66 Outdoor Use Switched**

2  **IP20**

EMC Filter

- F** Internal EMC Filter
- 0** No Internal EMC Filter

IP20

Size	1	2	3	4	5
mm Height	173	221	261	420	486
mm Width	83	110	131	171	222
mm Depth	123	150	175	212	226
kg Weight	1.0	1.7	3.2	9.1	18.1
Fixings	4xM5	4xM5	4xM5	4xM8	4xM8

IP66

Size	1	2	3	4
mm Height	232	257	310	360
mm Width	161	188	211	240
mm Depth	162	182	235	271
kg Weight	2.3	3.5	6.6	9.5
Fixings	4xM4	4xM4	4xM4	4xM4

Drive Specification

Input Ratings	Supply Voltage	110 – 115V ± 10% 200 – 240V ± 10% 380 – 480V ± 10%	Programming	Keypad	Built-in keypad as standard Optional remote mountable keypad	I/O Specification	Power Supply	24 Volt DC, 100mA, Short Circuit Protected 10 Volt DC, 10mA for Potentiometer	
	Supply Frequency	48 – 62Hz		Display	7 Segment LED		Programmable Inputs	4 Total 2 Digital 2 Analog / Digital selectable	
	Displacement Power Factor	> 0.98		PC	OptiTools Studio		Digital Inputs	8 – 30 Volt DC, internal or external supply Response time < 4ms	
	Phase Imbalance	3% Maximum allowed		Control Specification	Control Method		Sensorless Vector Speed Control PM Vector Control BLDC Control Synchronous Reluctance	Analog Inputs	Resolution: 12 bits Response time: < 4ms Accuracy: ± 2% full scale Parameter adjustable scaling and offset
	Inrush Current	< rated current			PWM Frequency		4–32kHz Effective	Programmable Outputs	2 Total 1 Analog / Digital 1 Relay
	Power Cycles	120 per hour maximum, evenly spaced			Stopping Mode		Ramp to stop: User Adjustable 0.1–600 secs Coast to stop	PTC Input	Motor PTC / Thermistor Input Trip Level: 2.5Ω
Output Ratings	Output Power	110V 1 Ph Input: 0.5–1.5HP (230V 3 Ph Output) 230V 1 Ph Input: 0.37–4kW (0.5–5HP) 230V 3 Ph Input: 0.37–18.5kW (0.5–25HP) 400V 3 Ph Input: 0.75–37kW 460V 3 Ph Input: 1–50HP	Fieldbus	Braking	Motor Flux Braking Built-in braking transistor (not frame size 1)	Application Features	Relay Outputs	Maximum Voltage: 250 VAC, 30 VDC Switching Current Capacity: 6A AC, 5A DC	
	Overload Capacity	150% for 60 Seconds 175% for 2.5 seconds		Skip Frequency	Single point, user adjustable		Analog Outputs	0 to 10 Volt	
	Output Frequency	0 – 500Hz, 0.1Hz resolution		Setpoint Control	Analog Signal		0 to 10 Volts 10 to 0 Volts 0 to 20mA 20 to 0mA 4 to 20mA 20 to 4mA	PI Control	Internal PI Controller Standby / Sleep Function
	Acceleration Time	0.01 – 600 seconds			Digital		Motorised Potentiometer (Keypad) Modbus RTU CANopen EtherNet/IP		Fire Mode
	Deceleration Time	0.01 – 600 seconds			Built-in		CANopen	125–1000 kbps	Fault Memory
	Typical Efficiency	> 98%		Modbus RTU			9.6–115.2 kbps selectable	Data Logging	
Ambient Conditions	Temperature	Storage: –40 to 60°C Operating: –20 to 50°C	Enclosure	Ingress Protection		IP20, IP66	Monitoring	Hours Run Meter	
	Altitude	Up to 1000m ASL without derating Up to 2000m maximum UL approved Up to 4000m maximum (non UL)			Standards Compliance		Low Voltage Directive	Adjustable speed electrical power drive systems. EMC requirements	
	Humidity	95% Max, non condensing					EMC Directive	2014/30/EU Cat C1 according to EN618003:2004	
	Vibration	Conforms to EN61800-5-1					Machinery Directive	2006/42/EC	
Enclosure	Ingress Protection	IP20, IP66	Modbus RTU	9.6–115.2 kbps selectable		CE, UL, RCM	Conformance	CE, UL, RCM	

OPTIDRIVE™ E³

For Single Phase Motors

IP20

IP66

Up to 1.1kW

Single Phase Motor Control for PSC & Shaded-Pole Motors

Key Features

- ✓ 110–115V and 200–240V models
- ✓ Small mechanical envelope
- ✓ Rugged industrial operation
- ✓ Fast setup, and simple operation with 14 basic parameters
- ✓ Unique motor control strategy optimised for single phase motors
- ✓ Motor current and rpm indication
- ✓ Built in PI control, EMC filter (C1) & brake chopper
- ✓ Application macros for industrial, fan and pump operation
- ✓  Bluetooth® connectivity

Modbus RTU

CAN

on-board as standard

150% overload for 60 secs
(175% for 2 secs)



Pump control in swimming pools & spas

Simple airflow control



Dedicated to Single Phase Motor Control

Designed to be cost effective and easy to use, the Optidrive E3 for Single Phase Motors is for use with PSC (Permanent Split Capacitor) or Shaded-Pole Single Phase induction motors.

Optidrive E3 for Single Phase Motors uses a revolutionary motor control strategy to achieve reliable intelligent starting of single phase motors.

- Removes the need for 3 phase supply wiring
- Provides the same performance features as the 3 phase Optidrive E3
- The ideal energy saving solution where high starting torque is not required — typically including fans, blowers, centrifugal pumps, fume extractors and air flow controllers

Special Boost Phase

To ensure reliable starting of single phase motors, the drive initially ramps the motor voltage up to rated voltage whilst maintaining a fixed starting frequency, before reducing the frequency and voltage to the desired operating point.

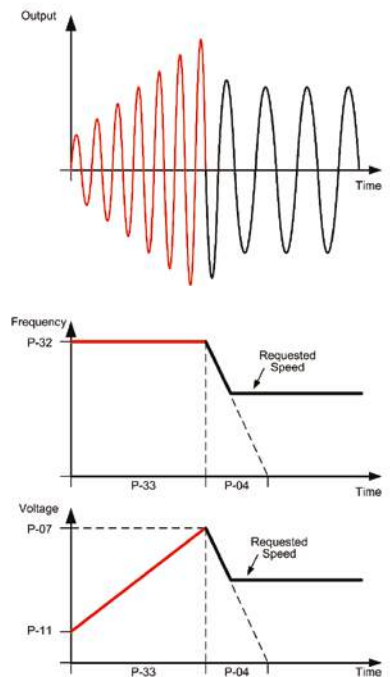

OPTIDRIVE™ E³

For Single Phase Motors

kW	HP	Amps	Size	Model Code											
				Product Family	Generation	Frame Size	Voltage Code	Capacity	Supply Phases	EMC Filter	Brake Transistor	Enclosure Type	Single Phase Output		
110-115V ± 10% 1 Phase Input	0.37	0.5	7	1	ODE - 3 - 1	1	0070	- 1	# 1	# - 01					
	0.55	0.75	10.5	2	ODE - 3 - 2	1	0105	- 1	# 4	# - 01					
200-240V ± 10% 1 Phase Input	0.37	0.5	4.3	1	ODE - 3 - 1	2	0043	- 1	# 1	# - 01					
	0.75	1	7	1	ODE - 3 - 1	2	0070	- 1	# 1	# - 01					
	1.1	1.5	10.5	2	ODE - 3 - 2	2	0105	- 1	# 4	# - 01					

Replace # in model code with colour-coded option

Enclosure Types



IP20

Size	1	2
mm Height	173	221
mm Width	83	110
mm Depth	123	150
kg Weight	1.0	1.7
Fixings	4 x M5	4 x M5

IP66

Size	1	2
mm Height	232	257
mm Width	161	188
mm Depth	162	182
kg Weight	2.3	3.5
Fixings	4 x M4	4 x M4

EMC Filter

F	Internal EMC Filter
0	No Internal EMC Filter

Model Code Guide:

ODE-3-120043-3F12-01

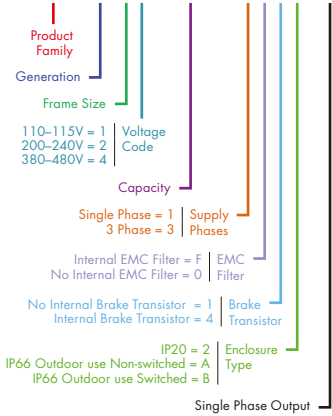

Drive Specification

Input Ratings	Supply Voltage	110 - 115V ± 10% 200 - 240V ± 10%	Control Specification	Control Method	V/F Voltage Energy Optimised V/F	Application Features	PI Control	Internal PI Controller Standby / Sleep Function	
	Supply Frequency	48 - 62Hz		PWM Frequency	4-32kHz Effective		Fire Mode	Selectable Speed Setpoint (Fixed / PI / Analog / Fieldbus)	
	Displacement Power Factor	> 0.98		Stopping Mode	Ramp to stop: User Adjustable 0.1-600 secs Coast to stop		Maintenance & Diagnostics	Fault Memory	Last 4 Trips stored with time stamp
	Phase Imbalance	3% Maximum allowed		Braking	Motor Flux Braking Built-in braking transistor (frame size 2)		Data Logging		Logging of data prior to trip for diagnostic purposes: Output Current Drive Temperature DC Bus Voltage
	Inrush Current	< rated current		Skip Frequency	Single point, user adjustable		Monitoring		Hours Run Meter
	Power Cycles	120 per hour maximum, evenly spaced		Setpoint Control	Analog Signal 0 to 10 Volts 10 to 0 Volts 0 to 20mA 20 to 0mA 4 to 20mA 20 to 4mA		Standards Compliance	Low Voltage Directive	Adjustable speed electrical power drive systems. EMC requirements
Output Ratings	Output Power	110V 1 Ph Input: 0.5-0.75HP 230V 1 Ph Input: 0.37-1.1kW (0.5-1.5HP)	Fieldbus	Digital	Motorised Potentiometer (Keypad) Modbus RTU CANopen EtherNet/IP	EMC Directive	2014/30/EU 230V 1Ph, Filtered Units : Cat C1 according to EN61800-3:2004		
	Overload Capacity	150% for 60 Seconds 175% for 2.5 seconds		Built-in	CANopen 125-1000 kbps Modbus RTU 9.6-115.2 kbps selectable		Machinery Directive	2006/42/EC	
	Output Frequency	0 - 500Hz, 0.1Hz resolution		I/O Specification	Power Supply		24 Volt DC, 100mA, Short Circuit Protected 10 Volt DC, 10mA for Potentiometer	Conformance	CE, UL, RCM
	Acceleration Time	0.01 - 600 seconds			Programmable Inputs		4 Total 2 Digital 2 Analog / Digital selectable		
Deceleration Time	0.01 - 600 seconds	Digital Inputs	8 - 30 Volt DC, internal or external supply Response time < 4ms						
Typical Efficiency	> 98%	PTC Input	Motor PTC / Thermistor Input Trip Level: 2.5Ω						
Ambient Conditions	Temperature	Storage: -40 to 60°C Operating: -20 to 50°C	Analog Inputs	Resolution: 12 bits Response time: < 4ms Accuracy: ± 2% full scale Parameter adjustable scaling and offset					
	Altitude	Up to 1000m ASL without derating Up to 2000m maximum UL approved Up to 4000m maximum (non UL)	Programmable Outputs	2 Total 1 Analog / Digital 1 Relay					
	Humidity	95% Max, non condensing	Relay Outputs	Maximum Voltage: 250 VAC, 30 VDC Switching Current Capacity: 6A AC, 5A DC					
Enclosure	Ingress Protection	IP20, IP66	Analog Outputs	0 to 10 Volt					
	Programming	Keypad	Built-in keypad as standard Optional remote mountable keypad						
Display		7 Segment LED							
PC		OptiTools Studio							

Energy Efficient Fan & Pump Control

- AC Induction (IM) Motors
- AC Permanent Magnet (PM) Motors
- Brushless DC (BLDC) Motors
- Synchronous Reluctance (SynRM) Motors



Multi Language
Text Display





OPTIFLOW™
Multiple Pump
Control

BACnet™
MS/TP
built-in as standard

Internal
EMC Filter

Fire Mode

Key Features

- ECO Vector Motor Control 
- Energy Optimised Design 
- Internal EMC Filter 
- Low Noise Operation 

How much energy could you save?

Estimate potential energy savings, CO₂ emissions and financial savings for your application with the Invertek Drives Energy Savings Calculator app.



www.invertekdrives.com/calculator



IP20 / NEMA 1



IP55 / NEMA 12



IP66 / NEMA 4X

Save Energy

Accurate speed control of fans and pumps provides the most energy efficient control method

Energy optimisation function minimises energy usage in real time under partial load conditions

Sleep & wake functions ensure operation only when required

Save Money

Advanced on-board features remove the need for peripheral equipment

Intelligent maintenance interval timing allows programmable maintenance reminders, avoiding costly downtime

Automatic load monitoring provides an early warning of potential faults, such as belt failures or blocked filters

Save Time

Built in keypad and OLED text display provides intuitive operation

Simple parameter structure with carefully selected default values reduce commissioning time

Practical design allows easy access to power and control terminals without specialist tools

Fire Override Mode

Fire override mode ignores signals and alarms, keeping the drive operating for as long as possible.

This feature is crucial for ensuring smoke extraction from buildings in the event of a fire.

Selectable Normally Open or Normally Closed logic means that the Optidrive Eco can be easily configured to the signal produced by your fire management system.

With an independently set speed for fire mode operation, selectable as either forward or reverse direction, the Optidrive Eco has the flexibility to match the needs of your fire control system.

Improved Fan Efficiency

Unique Eco Vector Sensorless Control

Optidrive Eco uses advanced motor control, designed to provide the most energy efficient motor control possible. Operation with standard IM Motors, Permanent Magnet or Synchronous Reluctance motors is possible, all without requiring any feedback device or optional modules – simply change parameters to suit the connected motor, autotune and operate!

Eco Vector continuously adjusts in real time to provide the most efficient operating conditions for the load, typically reducing energy consumption by 2 – 3% compared to standard AC drives – providing similar long term costs savings to selecting a higher efficiency motor.

Energy Optimised Design

Optidrive Eco up to frame size 5 are designed with film capacitors, replacing the traditional electrolytic capacitors used in the DC link. Film capacitors have lower losses, and also remove the need for AC, DC or swinging chokes, improving overall drive efficiency. Efficiency is improved by up to 4% compared to standard AC drives, whilst also reducing supply current total harmonic distortion (iTHD), improving the Real Power Factor and reducing total input current, leading to cost savings on installation through reduced cable and fuse ratings and smaller supply transformer rating.

PID Control

Optidrive Eco has a PID controller built in that is fully integrated with both HVAC and energy efficient features and is packaged in a user friendly way to ensure ease of use and fast commissioning.

Energy Efficient Pump Control

OPTIFLOW™

A standard feature on every Optidrive Eco

OPTIFLOW™

Co-ordinated pump station control, built into each drive as standard, allows independent control of multiple pump applications.

- All pumps operate as variable speed for maximum energy saving.
- Equal run time sharing across every pump.
- Automatic system reconfiguration in the event of a pump fault (including the master pump).
- Continued system operation when drives are individually powered off (including the master drive).
- Communication and +24V control voltage shared between drives via a standard RJ45 patch lead.
- Independent maintenance indicators for each pump.
- Any pump can be switched to Hand operation at the touch of a button, and will automatically rejoin the network when switched back to Auto.
- For waste water applications each pump can be set for blockage/ragging detection and activate an automatic de-ragging/pump cleaning cycle.
- Optional mains isolator with lock-off for safe pump maintenance.
- Optiflow function configured through simple parameter set-up and intelligent drive self configuration.

Setpoint Control

Independent pump system control

OptiFlow Communications

← Feedback signal



See **OPTIFLOW™** in action

Scan to watch the video or visit <http://youtu.be/9QQ89bQYdfs>





Pump Efficiency

In-built Sleep Mode with Auto-boost

Sleep mode saves energy by detecting when a pump is running inefficiently and producing little useful work. Optidrive Eco can be programmed to enter into a sleep/disabled mode until the demand increases. To help prevent sleep mode oscillation, Optidrive Eco can automatically initiate a boost cycle to increase pressure on starting or stopping.

Drive Controlled Bypass

Intelligent features within the Optidrive Eco allow a bypass circuit to be implemented. Activation of Bypass mode can be determined intelligently by the Optidrive Eco drive based on a command from the building management system. The drive can be set to automatically select bypass mode when entering into a trip condition ensuring minimal disruption to service.

Avoid Pump Downtime

Blockage Detect/Clear

Optidrive Eco can detect potential pump blockages in real time and trigger a programmed cleaning cycle to automatically clear them, preventing downtime.

Pump Clean/Stir Cycle

Triggered by a settable period of inactivity, a configurable cleaning cycle can be run to clear sediment, ensuring the pump is ready to run when needed.

Dry Run Protection

Optidrive Eco can evaluate a pump's speed/power and shut it off or warn when the pump starts to run dry, protecting it from heat/friction damage.

Cascade Control Pump Staging

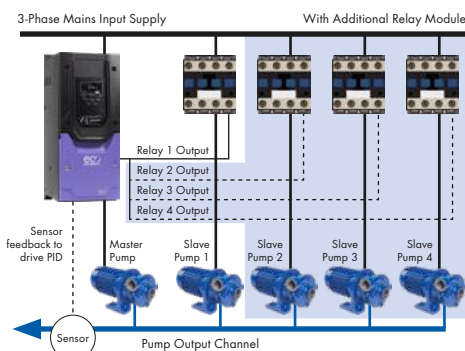

Variable speed duty pump with up to 4 assist pumps

Optidrive Eco can provide automatic operating time monitoring and balancing for assist pumps to share duty cycle. Run time clocks for all fixed speed assist pumps are maintained and visible within the Optidrive Eco for integration into the pump system maintenance schedules.

Motor Preheat Function

Optidrive Eco features a motor preheat function to help ensure moisture is not permitted to collect on the motor in periods of inactivity and prior to motor start up. In addition, the motor preheat function can be used to keep condensation from developing on the motor as the motor cools down immediately following a stop. The feature is fully configurable, meaning the pump can be always available the instant it is required.

Replace # in model code with enclosure/display option

	kW	HP	Amps	Frame Size	Model Code							IP20 Cabinet Mount	IP55 TFT Display	Indoor IP66 Non Switched	Indoor IP66 with Disconnect	Outdoor IP66 Non Switched	Outdoor IP66 with Disconnect	
					Product Family	Generation	Frame Size	Voltage Code	Output Rating	Supply Phases	EMC Filter							Capacitor
200-240V ± 10% 1 Phase Input	0.75	1	4.3	2	ODV	-3	-2	2	0043	-1	F	1	#	2-MN	X-TN	D-TN	A-MN	E-MN
	1.5	2	7	2	ODV	-3	-2	2	0070	-1	F	1	#	2-MN	X-TN	D-TN	A-MN	E-MN
	2.2	3	10.5	2	ODV	-3	-2	2	0105	-1	F	1	#	2-MN	X-TN	D-TN	A-MN	E-MN
200-240V ± 10% 3 Phase Input	0.75	1	4.3	2	ODV	-3	-2	2	0043	-3	F	1	#	2-MN	X-TN	D-TN	A-MN	E-MN
	1.5	2	7	2	ODV	-3	-2	2	0070	-3	F	1	#	2-MN	X-TN	D-TN	A-MN	E-MN
	2.2	3	10.5	2	ODV	-3	-2	2	0105	-3	F	1	#	2-MN	X-TN	D-TN	A-MN	E-MN
	4	5	18	3	ODV	-3	-3	2	0180	-3	F	1	#	2-MN	X-TN	D-TN	A-MN	E-MN
	5.5	7.5	24	3	ODV	-3	-3	2	0240	-3	F	1	#	2-MN	X-TN	D-TN	A-MN	E-MN
	7.5	10	30	3	ODV	-3	-3	2	0300	-3	F	1	#	2-MN	X-TN	D-TN	A-MN	E-MN
	7.5	10	30	4	ODV	-3	-4	2	0300	-3	F	1	#	2-MN	N-MN			
	11	15	46	4	ODV	-3	-4	2	0460	-3	F	1	#	2-MN	N-MN		A-MN	E-MN
	15	20	61	5	ODV	-3	-5	2	0610	-3	F	1	#	2-MN	N-MN			
	18.5	25	72	5	ODV	-3	-5	2	0720	-3	F	1	#	2-MN	N-MN			
	22	30	90	5	ODV	-3	-5	2	0900	-3	F	1	#	2-MN	N-MN			
	30	40	110	6	ODV	-3	-6	2	1100	-3	F	1	#	2-MN	N-MN			
	30	40	110	6A	ODV	-3	-6	2	1100	-3	F	1	#	2-MN				
	37	50	150	6	ODV	-3	-6	2	1500	-3	F	1	#	2-MN	N-MN			
	37	50	150	6A	ODV	-3	-6	2	1500	-3	F	1	#	2-MN				
	45	60	180	6	ODV	-3	-6	2	1800	-3	F	1	#	2-MN	N-MN			
	45	60	180	6B	ODV	-3	-6	2	1800	-3	F	1	#	2-MN				
55	75	202	7	ODV	-3	-7	2	2020	-3	F	1	#	2-MN	N-MN				
75	100	248	7	ODV	-3	-7	2	2480	-3	F	1	#	2-MN	N-MN				
380-480V ± 10% 3 Phase Input	0.75	1	2.2	2	ODV	-3	-2	4	0022	-3	F	1	#	2-MN	X-TN	D-TN	A-MN	E-MN
	1.5	2	4.1	2	ODV	-3	-2	4	0041	-3	F	1	#	2-MN	X-TN	D-TN	A-MN	E-MN
	2.2	3	5.8	2	ODV	-3	-2	4	0058	-3	F	1	#	2-MN	X-TN	D-TN	A-MN	E-MN
	4	5	9.5	2	ODV	-3	-2	4	0095	-3	F	1	#	2-MN	X-TN	D-TN	A-MN	E-MN
	5.5	7.5	14	2	ODV	-3	-2	4	0140	-3	F	1	#	2-MN			A-MN	E-MN
	5.5	7.5	14	3	ODV	-3	-3	4	0140	-3	F	1	#	2-MN	X-TN	D-TN		
	7.5	10	18	3	ODV	-3	-3	4	0180	-3	F	1	#	2-MN	X-TN	D-TN	A-MN	E-MN
	11	15	24	3	ODV	-3	-3	4	0240	-3	F	1	#	2-MN	X-TN	D-TN	A-MN	E-MN
	15	20	30	3	ODV	-3	-3	4	0300	-3	F	1	#	2-MN			A-MN	E-MN
	15	20	30	4	ODV	-3	-4	4	0300	-3	F	1	#	2-MN	N-MN			
	18.5	25	39	4	ODV	-3	-4	4	0390	-3	F	1	#	2-MN	N-MN		A-MN	E-MN
	22	30	46	4	ODV	-3	-4	4	0460	-3	F	1	#	2-MN	N-MN		A-MN	E-MN
	30	40	61	5	ODV	-3	-5	4	0610	-3	F	1	#	2-MN	N-MN			
	37	50	72	5	ODV	-3	-5	4	0720	-3	F	1	#	2-MN	N-MN			
	45	60	90	5	ODV	-3	-5	4	0900	-3	F	1	#	2-MN	N-MN			
	55	75	110	6	ODV	-3	-6	4	1100	-3	F	1	#	2-MN	N-MN			
	55	75	110	6A	ODV	-3	-6	4	1100	-3	F	1	#	2-MN				
	75	100	150	6	ODV	-3	-6	4	1500	-3	F	1	#	2-MN	N-MN			
	75	100	150	6A	ODV	-3	-6	4	1500	-3	F	1	#	2-MN				
	90	150	180	6	ODV	-3	-6	4	1800	-3	F	1	#	2-MN	N-MN			
90	150	180	6B	ODV	-3	-6	4	1800	-3	F	1	#	2-MN					
110	175	202	6B	ODV	-3	-6	4	2020	-3	F	1	#	2-MN					
110	175	202	7	ODV	-3	-7	4	2020	-3	F	1	#	2-MN	N-MN				
132	200	240	7	ODV	-3	-7	4	2400	-3	F	1	#	2-MN	N-MN				
160	250	302	7	ODV	-3	-7	4	3020	-3	F	1	#	2-MN	N-MN				
200	300	370	8	ODV	-3	-8	4	3700	-3	#	1	#	2-MN	N-MN				
250	400	480	8	ODV	-3	-8	4	4800	-3	#	1	#	2-MN	N-MN				
500-600V ± 10% 3 Phase Input	0.75	1	2.1	2	ODV	-3	-2	6	0021	-3	0	1	#	2-MN	X-TN	D-TN	A-MN	E-MN
	1.5	2	3.1	2	ODV	-3	-2	6	0031	-3	0	1	#	2-MN	X-TN	D-TN	A-MN	E-MN
	2.2	3	4.1	2	ODV	-3	-2	6	0041	-3	0	1	#	2-MN	X-TN	D-TN	A-MN	E-MN
	4	5	6.5	2	ODV	-3	-2	6	0065	-3	0	1	#	2-MN	X-TN	D-TN	A-MN	E-MN
	5.5	7.5	9	2	ODV	-3	-2	6	0090	-3	0	1	#	2-MN	X-TN	D-TN	A-MN	E-MN
	7.5	10	12	3	ODV	-3	-3	6	0120	-3	0	1	#	2-MN	X-TN	D-TN	A-MN	E-MN
	11	15	17	3	ODV	-3	-3	6	0170	-3	0	1	#	2-MN	X-TN	D-TN	A-MN	E-MN
	15	20	22	3	ODV	-3	-3	6	0220	-3	0	1	#	2-MN			A-MN	E-MN
	15	20	22	4	ODV	-3	-4	6	0220	-3	0	1	#	2-MN	N-MN			
	18.5	25	28	4	ODV	-3	-4	6	0280	-3	0	1	#	2-MN	N-MN		A-MN	E-MN
	22	30	34	4	ODV	-3	-4	6	0340	-3	0	1	#	2-MN	N-MN		A-MN	E-MN
	30	40	43	4	ODV	-3	-4	6	0430	-3	0	1	#	2-MN	N-MN		A-MN	E-MN
	37	50	54	5	ODV	-3	-5	6	0540	-3	0	1	#	2-MN	N-MN			
	45	60	65	5	ODV	-3	-5	6	0650	-3	0	1	#	2-MN	N-MN			
	55	75	78	6	ODV	-3	-6	6	0780	-3	0	1	#	2-MN	N-MN			
	75	100	105	6	ODV	-3	-6	6	1050	-3	0	1	#	2-MN	N-MN			
	90	125	130	6	ODV	-3	-6	6	1300	-3	0	1	#	2-MN	N-MN			
110	150	150	6	ODV	-3	-6	6	1500	-3	0	1	#	2-MN	N-MN				

EMC Filter

- 0** No Internal EMC Filter
- F** Internal EMC Filter
- R** High Performance EMC Filter

Drive Specification

Input Ratings	Supply Voltage	200 – 240V ± 10% 380 – 480V ± 10% 500 – 600V ± 10%
	Supply Frequency	48 – 62Hz
	Displacement Power Factor	> 0.98
	Phase Imbalance	3% Maximum allowed
	Inrush Current	< rated current
	Power Cycles	120 per hour maximum, evenly spaced
	Output Ratings	Output Power
Overload Capacity		110% for 60 seconds 150% for 15 seconds
Output Frequency		0 – 250Hz, 0.1Hz resolution
Typical Efficiency		> 98%
Ambient Conditions		Temperature: Storage: –40 to 60°C Operating: –10 to 50°C Altitude: Up to 1000m ASL without derating Up to 2000m maximum UL approved Up to 4000m maximum (non UL) Humidity: 95% Max, non condensing Vibration: Conforms to EN61800-5-1 2007, IEC 60068-2-6
Enclosure	Ingress Protection	IP20, IP55, IP66
	Programming	Keypad: Built-in keypad as standard Optional remote mountable keypad Display: Built-in multi language text display PC: OptiTools Studio
Control Specification	Control Method	Eco Sensorless Vector Open Loop Permanent Magnet Vector Open Loop BLDC Vector Open Loop Synchronous Reluctance Vector
	PWM Frequency	4 – 32kHz Effective
	Stopping Mode	Ramp to stop: User Adjustable 0.1–600 secs Coast to stop
	Braking	AC Flux Braking
Setpoint Control	Analog Signal	0 to 10 Volts / 10 to 0 Volts –10 Volts to +10 Volts 0 to 20mA / 20 to 0mA 4 to 20mA / 20 to 4mA
		Digital
	Digital	Motorised Potentiometer (Keypad) Modbus RTU BACnet MS/TP
Fieldbus Connectivity	Built-in	BACnet Application Specific Controller 9.6 - 76.8 kbps selectable Data Format: 8N1, 8N2, 8O1, 8E1 Modbus RTU 9.6 - 115.2 kbps selectable Data Format: 8N1, 8N2, 8O1, 8E1
	Optional	BACnet/IP Plug-in BACnet/IP interface Dual IAN ports Device Level Ring Other: PROFIBUS DP (DPV1) PROFINET IO DeviceNet EtherNet/IP EtherCAT Modbus TCP

I/O Specification	Power Supply	24 Volt DC, 100mA, Short Circuit Protected 10 Volt DC, 10mA for Potentiometer	
	Programmable Inputs	5 Total as standard (optional additional 3) 3 Digital (optional additional 3) 2 Analog / Digital selectable	
	Digital Inputs	Opto - Isolated 8 – 30 Volt DC, internal or external supply Response time < 4ms	
	Analog Inputs	Resolution: 12 bits Response time: < 4ms Accuracy: < 1% full scale Parameter adjustable scaling and offset	
	PTC Input	Motor PTC / Thermistor Input Trip Level : 2.5Ω	
	Programmable Outputs	2 Total 1 Analog / Digital 1 Relay	
	Relay Outputs	Maximum Voltage: 250 VAC, 30 VDC Switching Current Capacity: 5A	
	Analog Outputs	0 to 10 Volts / 10 to 0 Volts 0 to 20mA / 20 to 0mA 4 to 20mA / 20 to 4mA	
	Application Features	PID Control	Internal PID Controller Multi-setpoint Select Standby / Sleep Mode Boost Function
		Fire Mode	Bidirectional Selectable Speed Setpoint (Fixed / PID / Analog / Fieldbus)
Load Monitoring		High Current Protection (Fan / Bump Blocked) Low Current Protection (Broken Belt / Shaft) Pump Blockage Detection with Cleaning	
Duty / Assist / Standby		Built-in Multi-Pump Support Automatic Changeover on Fault Automatic Changeover on Time Fully Redundant	
Pump Control Features	Pump Blockage Detection	Pump load monitoring with autotune function, user configurable	
	Pump Cleaning	Adjustable Bi-directional Pump Cleaning Cycle operation	
	Multi-Pump Control	Control of fixed speed assist pumps (with cascade control module) Control of Duty, Assist and Standby variable speed pumps via internal Master – Slave network	
	Pump Stir	Automatic pump stir to prevent sediment build-up	
Maintenance & Diagnostics	Fault Memory	Last 4 Trips stored with time stamp	
	Data Logging	Logging of data prior to trip for diagnostic purposes: Output Current Drive Temperature DC Bus Voltage	
	Maintenance Indicator	Maintenance Indicator with user adjustable maintenance interval Onboard service life monitoring	
	Monitoring	Hours Run Meter Resettable & Non-Resettable kWh meters Cooling Fan Run Time	
Standards Compliance	Low Voltage Directive	2014/35/EU	
	EMC Directive	2014/30/EU	
	Additional Conformance	UL, cUL, EAC, RCM	
	Harmonic Currents	IEC61000-3-12	
Environmental Conditions	Designed to meet IEC 60721-3-3, in operation: IP20 Drives: 3S2/3C2 IP55 & 66 Drives: 3S3/3C3		

Model Code Guide

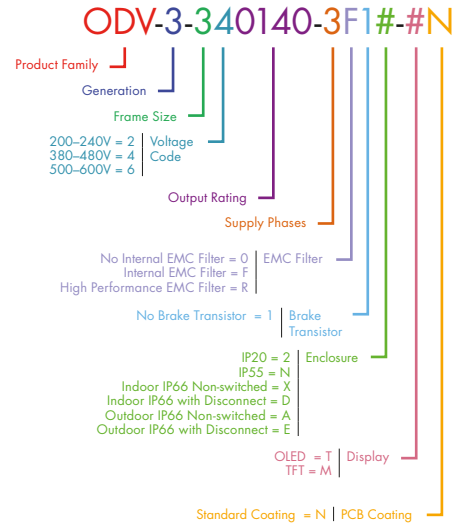

Connection Diagram

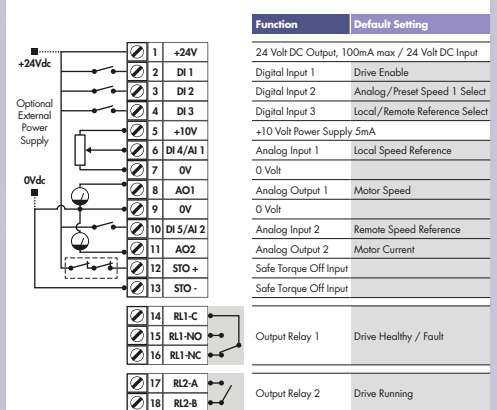

NOT TO SCALE



Size	IP20							IP66			IP55				
	2	3	4	5	6A	6B	8	2	3	4	4	5	6	7	8
mm Height	221	261	418	486	614	726	974	257	310	360	450	540	865	1280	1334
mm Width	110	131	172	233	286	330	444	188	211	240	171	235	330	330	444
mm Depth	185	205	240	260	320	320	423	182	235	271	252	270	332	358	423
kg Weight	1.8	3.5	9.2	18.1	32	43	124.5	3.5	6.6	9.5	11.5	23	55	89	TBC



POWER PRECISION CONTROL

THE NEW SIZE 8 RANGE

Now available in Optidrive P2 and Optidrive Eco ranges, combining the innovative features of these products with the ability to control motors rated up to 480 Amps.

It is available as IP20 for control cabinet mounting and as IP55 for direct mounting.



OPTIDRIVE™ Size 8
Up to 250kW / 400HP
380 – 480V

OPTIDRIVE™ Size 8

200 – 250kW / 300 – 400HP
380 – 480V



High Power Drive Module

Optidrive Frame Size 8 extends the power rating capacity of Optidrive P2 and Optidrive Eco products up to 250kW / 400HP.

Combining all the features of the standard products, and providing the ability to control motors with rated current up to 480Amps, Frame Size 8 is available in an IP20 enclosure suitable for control cabinet mounting.

Frame Size 8 comes with a built in EMC Filter to meet Category C3 with an option to upgrade to a High Performance EMC Filter that meets Category C2. The drive also has a built in choke as standard.

A new IP55 enclosure is also available and is designed for direct plant/control room mounting.



kW	HP	Amps
200	300	370
250	400	480

Model Code	Product Family	Generation	Frame Size	Voltage Code	Power Rating Code	Supply Phases	Power Type	EMC Filter	Brake Transistor
ODP - 2 - 8 4 200 - 3 K # 4 #									
ODP - 2 - 8 4 250 - 3 K # 4 #									
ODP - 2 - 8 4 300 - 3 H # 4 #									
ODP - 2 - 8 4 400 - 3 H # 4 #									



kW	HP	Amps
200	300	370
250	400	480

Model Code	Product Family	Generation	Frame Size	Voltage Code	Capacity	Supply Phases	Power Type	EMC Filter	Charger	Enclosure Type
ODV - 3 - 8 4 3700 - 3 # 1 #										
ODV - 3 - 8 4 4800 - 3 # 1 #										

- # Enclosure
 - 2-MN IP20 with TFT display
 - N-MN IP55 with TFT display
- # EMC Filter
 - O No Internal EMC Filter
 - F Internal EMC Filter
 - R High Performance EMC Filter

Options Include

OPT-2-L31500-00	Frame Size 8 AC Line Choke 500A, 1%
OPT-2-M3500-00	Frame Size 8 Output Choke 500A
OPT-2-L3500-00	Frame Size 8 AC Line Choke 500A, 4%
OPT-2-E3500-00	Frame Size 8 EMC Filter

Size 8 Drive Specification

Input Ratings	Supply Voltage	380 – 480V ± 10%	Ambient Conditions	Temperature	Storage: –40 to 60°C Operating: –10 to 50°C	
	Supply Frequency	48 – 62Hz		Altitude	Up to 1000m ASL without derating Up to 4000m maximum	
	Displacement Power Factor	> 0.98		Humidity	95% Max, non condensing	
	Phase Imbalance	3% Maximum allowed		Enclosure	Ingress Protection	IP20 / IP55
	Inrush Current	< rated current			Programming	Keypad
	Power Cycles	120 per hour maximum, evenly spaced		Display		Built-in multi language TFT display
Output Ratings	Output Power	400V 3Ph. Input: 200 & 250kW 460V 3Ph. Input: 300 & 400HP	Standards Compliance	PC	OptiTools Studio	
	Overload Capacity	P2: 150% for 60 seconds Eco: 110% for 60 seconds		Low Voltage Directive	2014/35/EU	
	Output Frequency	0 – 120Hz, 0.1Hz resolution		EMC Directive	2014/30/EU	
	Typical Efficiency	> 97%		Additional Conformance	UL, cUL, EAC, RCM, DNV	
				Harmonic Currents	Eco: IEC61000-3-12	

Dimensions

Enclosure	IP20	IP55
mm Height	974	1334
mm Width	444	444
mm Depth	423	423
kg Weight	124.5	TBC

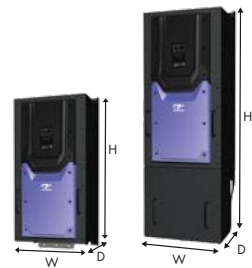

Keypads & Displays

OPTIPOINT 2

Remote Keypad & LED Display

OPT-2-OPOINT-IN



OPTIPAD

Remote Keypad & TFT Display



Optipad Language Support

OPT-3-OPPAD-IN

English
German
Spanish
Italian
French
Swedish
Russian
Polish
Portuguese
Finnish

OPT-3-OPPAD-TU

English
German
Turkish

Optiport 2 and Optipad units act as the remote keypad and display for the Optidrive on the network which has the same serial address. The physical layout and the operation of the Optiport keypad and display mimic the Optidrive exactly.

Specification

OPTIPOINT 2

- Real-time keypad and display operation mimics Optidrive
- Single electrical interface for power and data
- Communicates with any compatible drive across a network
- Easy keypad switching to other network addresses
- IP54 rated when through panel mounted
- Bright LED Display
- Membrane keypad
- Parameter lock function available
- 3m Data Cable included

OPTIPAD

In addition to Optiport 2 features, Optipad benefits from:

- Multi-language TFT Display
- IP55 rated

- Simple plug in RJ45 connection
- 24 Volt DC Power provided directly by the Optidrive
- RS485 2 Wire Signal Interface
- Operating Temperature: -10°C to +50°C
- Storage Temperature: -40°C to +60°C

Compatible with:

Optidrive E3
Optidrive P2
Optidrive Eco

Configuration

Depending on the requirement of the application, Optiport 2 and Optipad keypads can be used in the following different ways:

1 keypad with 1 drive



1 keypad with multiple Optidrives (up to 63 max)



2 keypads with 1 drive



2 keypads with multiple Optidrives (up to 63 max)



Add a communication interface or extend functionality

Optidrive Compatibility

			P2	Eco
Field Bus			OPT-2-PROFB-IN Supports PROFIBUS DPV1 Automatic Baud rate detection from 9.6kbps to 12mbps	
			OPT-2-DEVNT-IN Galvanically isolated bus electronics Automatic baud rate detection CIP Parameter Object Support	
			OPT-2-ETHNT-IN Two Ethernet /IP ports 10/100Mbit half duplex operation Supports DLR (Device Level Ring) and Linear network topology CIP Parameter object support	
			OPT-2-MODIP-IN Two Ethernet /IP ports 10/100Mbit half duplex operation Modbus TCP with IT functionality	
			OPT-2-ETCAT-IN Two Ethernet /IP ports 10/100Mbit half duplex operation EtherCAT slave device	
			OPT-2-PFNET-IN Two Ethernet /IP ports 10/100Mbit half duplex operation	
			OPT-2-BNTIP-IN Two Ethernet /IP ports 10/100Mbit half duplex operation Supports Linear network topology	
Encoder Feedback		OPT-2-ENCOD-IN Suitable for standard TTL type encoders Up to 4096ppr 5 Volt Power Supply on board Maximum Input Frequency up to 500kHz		
		OPT-2-ENCHT-IN Suitable for 24 Volt HTL type encoders Up to 4096ppr Up to 500kHz input frequency		
Extended I/O		OPT-2-EXTIO-IN Provides an additional 3 Digital Inputs 2 Relay (Volt Free) Outputs		
		OPT-2-CASCD-IN Provides an additional 3 Relay (Volt Free) Outputs Typical usage: Cascade control of Booster Pump sets		
External I/O		OPT-2-CANIO-IN Standalone external I/O module Additional 5 digital inputs Additional 3 relay outputs Connects via RJ45 socket		

OptiTools Studio

OPTISTICK Smart Rapid Commissioning Tool

OPT-3-STICK-IN

Powerful PC Software

Drive commissioning and parameter backup

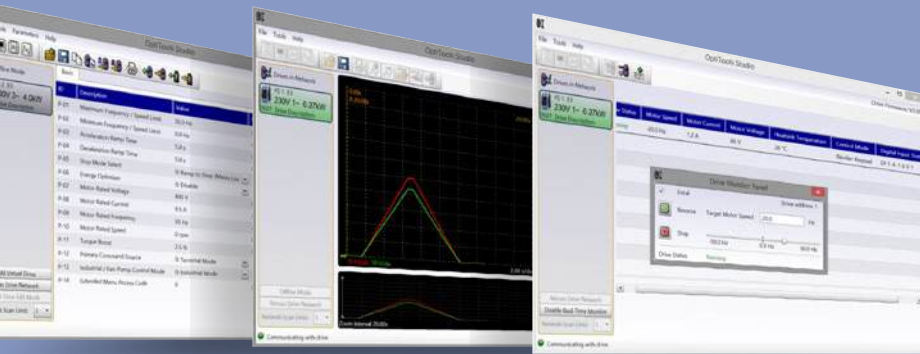

- Powerful PC based commissioning and programming software
- Multi Drive Network Support

Supports two key functions:

- Drive Programming & Commissioning
 - Parameter Upload, Download & Storage
 - Changed Parameter Highlighting
 - Parameter List Printing
- Provides Access to Optidrive P2 & Eco PLC programming function
 - Function Blocked Based PLC Logic Programming
 - Advanced Drive Control Functions
 - Multiple Functions can be easily combined to produce powerful solutions
 - Program protection to prevent unauthorised copying
- Real-time scope function and data logging
- Real-time data monitoring

Compatible with:

Windows Vista, Windows 7,
Windows 8, Windows 8.1 & Windows 10

- Allows copying, backup and restore of drive parameters
- Provides Bluetooth interface to a PC running OptiTools Studio or the OptiTools Mobile app on a smartphone
- Onboard NFC (Near Field Communication) for rapid data transfer

Compatible with:

Optidrive E3, Optidrive P2, Optidrive Eco



PC Connection Kit

OPT-2-USB485-OBUS



OPT-2-USB-OBUS is a dedicated PC connection kit for all Optidrive models, allowing direct connection from the PC USB port to the drive RJ45 communication connection for use with Optitools studio software.

Key Benefits

- To provide interface between PC and drive
- For use with OptiTools Studio PC software
- Provides electrical isolation between PC and drive network

Features

- Isolated USB - RS485 connection adaptor
- USB2.0
- Compatible with Windows XP, Vista, 7, 8, 8.1, 10
- Supports Optitools Studio PC software connection to the drive
- 1.5 metre cable lengths

Configuration

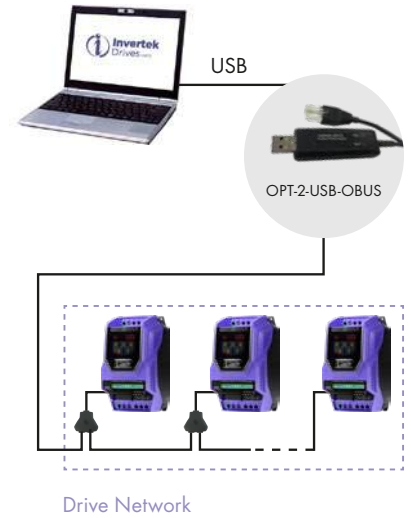

RS485 Data Cable Splitter

OPT-J455P (RJ45 1 - 2 way)

RS485 data cable splitter is an RJ45 1 to 2-way connection block



RJ45 Data Cables

RJ45 to RJ45 RS485 Data Cable, 0.5m length, Blue
OPT-J4505

RJ45 to RJ45 RS485 Data Cable, 1.0m length, Blue
OPT-J4510

RJ45 to RJ45 RS485 Data Cable, 3.0m length, Blue
OPT-J4530



EtherNet Module

OPT-2-ETHEG-IN

- ODVA compliant EtherNet/IP Modbus Translator Device
- Compatible with all drive platforms: P2, E3 & Eco
- Integrated network switch: simplifying network architecture
- Compatible with RSLogix and CoDeSys PLCs



RJ45 8 Way Network Hub

OPT-2-RJHUB-IN

RJ45 Terminator

OPT-2-RJTRM-IN



Input Chokes

Reduce supply harmonic current distortion and increase protection against mains voltage spikes and notches

Input chokes can be used to reduce the supply line harmonic currents and voltage distortion generated by almost all inverter drives on the market today. Invertek Drives have selected a range of chokes matched to the Optidrive range to provide the best reduction in supply current harmonics whilst also providing enhanced protection for the Optidrive against transient voltages ('spikes') or other mains borne interference.

Input chokes are available for the complete range of Optidrive products, and are recommended for use in all installations and in particular:

- where the local mains supply quality may be poor or unknown
- where high current switching loads such as large DC drives or soft starts are operating
- where the mains supply impedance is low
- in remote areas prone to lightning strikes

Fourier Analysis of Harmonic Distortion

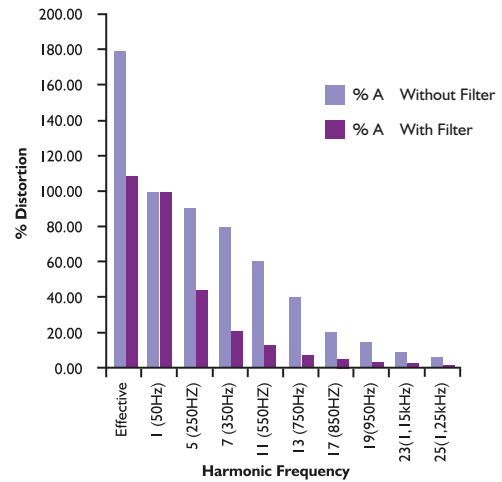

The graph shows the effect of using an input choke on typical 4kW/ 5HP drive. The 50Hz current is used as a reference and is the current which delivers the useful power to the motor. The reduction in the total effective (RMS) current is clear.

Part Number	Phases	Optidrive Size	Enclosure IP	Connection (mm ²)	L (mm)	H (mm)	B (mm)	Rated Volts	Rated Amps	Inductance (mH)	Weight (kg)
OPT-2-L1016-20	1	1	20	4	78	80	78	230 Max	16	1.8	1.1
OPT-2-L1025-20	1	2	20	10	85	158	76		25	1.1	1.8
OPT-2-L1016-66	1	1	66	4	82	70	70	230 Max	16	1.83	1.0
OPT-2-L1025-66	1	2	66	10	90	75	84		25	1.17	1.3
OPT-2-L3006-20	3	1	20	2.5	95	107	56	500 Max	6	4.8	1.3
OPT-2-L3010-20	3	2	20	2.5	125	127	71		10	2.9	2.5
OPT-2-L3036-20	3	3	20	10	190	205	82		36	0.81	7.2
OPT-2-L3050-20	3	4	20	16	190	220	102		50	0.58	8.7
OPT-2-L3090-20	3	5	20	35	240	280	107		90	0.32	16
OPT-2-L3006-66	3	1	66	2.5	115	88	74	600 Max	6	4.8	1.6
OPT-2-L3010-66	3	2	66	2.5	175	137	99		10	3.86	3.5
OPT-2-L3018-66	3	3	66	10	175	137	114		18	2.04	7
OPT-2-L3200-00	3	6	00	9	310	260	180	500	200	73.5	35
OPT-2-L3300-00	3	7	00	9	370	310	180		300	49.0	48

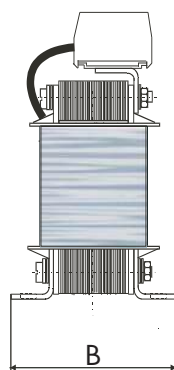
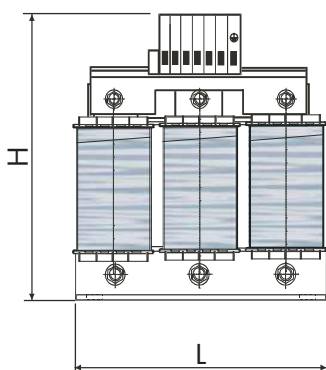

Output filters improve the quality of the output waveform

In most applications, the unfiltered output from an inverter drive gives satisfactory performance but to improve system functionality, reliability and longevity, output filtering is strongly recommended in some applications, including:

- Long motor cables, up to 200m
- High capacitance motor cables (i.e. typical "pyro" wire, used for fire protection)
- Multiple motors connected in parallel
- Motors without inverter grade insulation (typically older motors)

Key Features

- Limits output voltage gradient, typically $<200V/\mu s$
- Limits transient over voltages at the motor terminals, typically $<1000V$
- Suppression of mains conducted interference in lower frequency ranges
- Compensation of capacitive load currents
- Reduction of RFI emissions from the motor cable
- Reduction of motor losses and audible noise caused by ripple

Comparison of Characteristics

Without filter

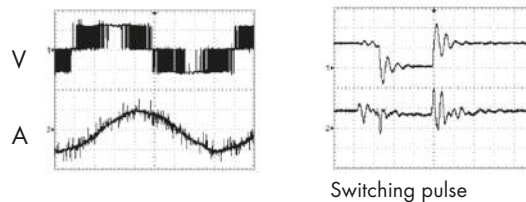

With filter

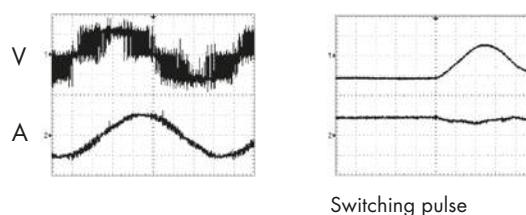

Note: Switching pulse rises slower and to a lower amplitude with filter.

Part Number	Optidrive Size	Enclosure IP	Connection (mm ²)	L (mm)	H (mm)	B (mm)	Rated Volts	Rated Amps	Inductance (mH)	Weight (kg)
OPT-2-M3008-20	1	20	2.5	95	107	61	500 Max	8	2.0	1.5
OPT-2-M3012-20	2	20	4	125	158	76		12	1.7	2.8
OPT-2-M3030-20	3	20	10	155	185	66		30	0.5	4.2
OPT-2-M3075-20	4 & 5	20	35	190	223	92		75	0.22	8.6
OPT-2-M3180-00	5 & 6	00	11	360	263	180	400 Max	180	0.09	30
OPT-2-M3300-00	7	00	9	380	310	180		300	0.053	48
OPT-2-M3008-66	1	66	2.5	115	85	74	600 Max	8	2.0	1.7
OPT-2-M3012-66	2	66	2.5	140	110	87		12	1.2	3.2
OPT-2-M3018-66	3	66	10	140	110	87		18	0.9	3.2

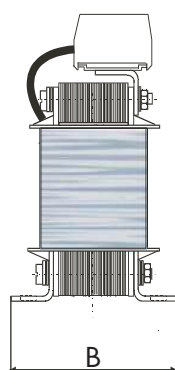
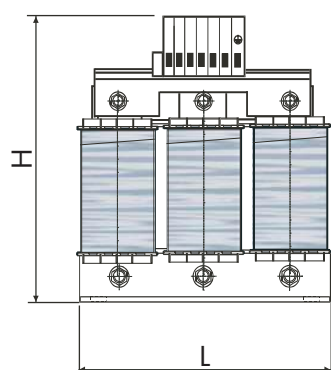

OPTIFILTER

RFI Line Filters

All Optidrive products are manufactured as standard with an internal EMC filter, unless specified by the customer. In general, this internal filter will provide compliance with international standard requirements for the majority of industrial installations and applications.

Where a higher standard of EMC compliance is desired or required, Invertek Drives can provide a range of suitable filters to ensure that an EMC compliant solution for all possible applications can be realised.

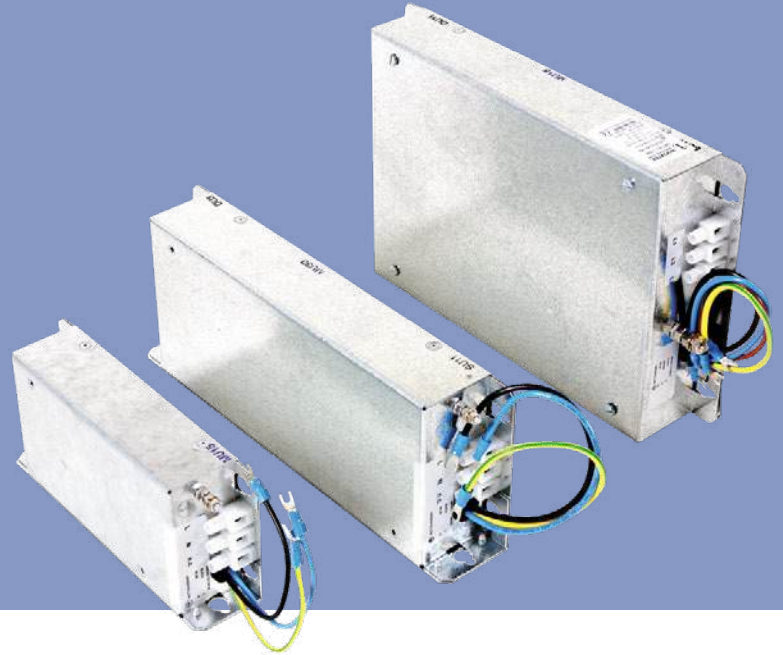

Part Number	Supply Phases	Optidrive Size	Enclosure IP	Length (mm)	Width (mm)	Depth (mm)	Rated Amps	Weight (kg)
OPT-2-E1010-20	1	1	20	180	70	65	10	1.5
OPT-2-E1025-20	1	2	20	250	70	65	25	2.8
OPT-2-E1010-66	1	1	66	180	70	65	10	1.5
OPT-2-E1025-66	1	2	66	250	70	65	25	2.8
OPT-2-E3006-20	3	1	20	210	85	60	6	2.7
OPT-2-E3016-20	3	2	20	230	120	65	16	2.7
OPT-2-E3025-20	3	3	20	230	120	65	25	2.7
OPT-2-E3050-20	3	4	20	115	150	65	50	TBC
OPT-2-E3080-20	3	5	20	373	170	65	80	TBC
OPT-2-E3180-20	3	6	20	470	180	115	180	TBC
OPT-2-E3300-00	3	7	0	660	260	130	300	TBC
OPT-2-E3006-66	3	1	66	210	85	60	6	2.7
OPT-2-E3016-66	3	2	66	230	120	65	16	2.7
OPT-2-E3025-66	3	3	66	200	150	65	25	2.7

OPTIBRAKE

Dynamic Braking Resistors

Optibrake dynamic braking resistors are designed specifically for the Optidrive range. For use with high inertia loads which need to be stopped rapidly. Optibrake dynamic braking resistors assist the Optidrive in managing the electrical energy returned from the motor during braking by converting it to heat energy.



Part Number	Optidrive Size	Resistance	Rated Voltage	Rated Power (W)	
				Continuous	Peak
OD-BR100-IN	2, 3	100	900 VDC	200	12000
OD-BRES4-IN	4, 5	22	900 VDC	500	21000



Local Isolator



Local isolator option allows complete disconnection of the incoming AC power to the drive. The isolator mounts directly to the drive, and provides a local disconnect option. The handle can be padlocked in the off position for safe maintenance.

Part Number	Optidrive Size	H (mm)	W (mm)	D (mm)
OPT-2-ISOLO-S4	4	170	173	80
OPT-2-ISOLO-S5	5	230	235	100

Through Hole Mount Kit

Through hole mount kits allow optidrive to be mounted through panel, ensuring that the heat from the drives heat sink is kept separate from the control electronics. This allows the optimum panel cooling arrangement to be used, with best possible separation of hot and cold air.

Through panel mounting kits can be used with all IP55 frame size 4–7 units.

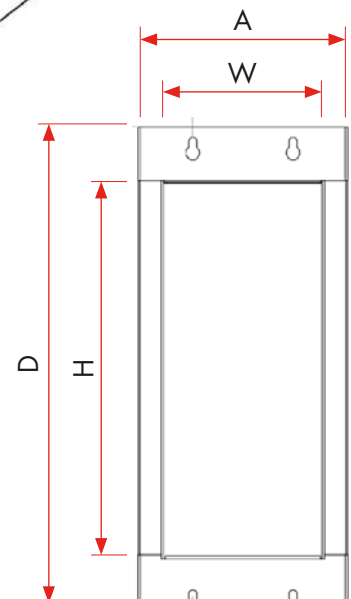
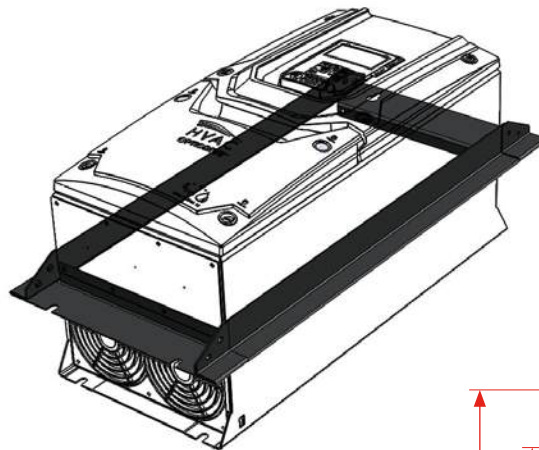

Part Number	Optidrive Size	Panel Cut Out Dimensions		Mount Dimensions	
		H mm (in)	W mm (in)	A mm (in)	D mm (in)
OPT-2-THMT04	4	425 (17.3)	180 (7.09)	228 (8.98)	521.5 (20.53)
OPT-2-THMT05	5	515 (21.26)	240 (9.65)	292 (11.5)	612.5 (24.11)
OPT-2-THMT06	6	815 (34.06)	335 (13.39)	398 (15.67)	924 (36.38)
OPT-2-THMT07	7	1230 (50.4)	335 (13.39)	398 (15.67)	1342 (52.83)

	Part Number	Description	E3	P2	Eco
Braking Resistors	OD-BR100-IN	Brake Resistor, Size 2, 100R, 200W	•	•	
	OPT-BR050-IN-155	Brake Resistor, IP55, Size 2, 200W, 50R	•	•	
	OD-BRES4-IN	Brake Resistor, Size 4, 33R, 500W		•	
Communication Interfaces	OPT-2-ETCAT-IN	EtherCAT Plug In Interface Module		•	•
	OPT-2-PROFB-IN	Profibus DPV-1 Plug In Interface Module		•	•
	OPT-2-PFNET-IN	Profinet IO Plug In Interface Module		•	•
	OPT-2-ETHNT-IN	EthernetIP Plug In Interface Module		•	•
	OPT-2-DEVNT-IN	DeviceNet Plug In Interface Module		•	•
	OPT-2-BNTIP-IN	Bacnet IP Plug In Interface		•	•
	OPT-2-MODIP-IN	Modbus TCP Plug In Interface Module		•	•
	OD-PROFB-IN	Profibus External Gateway & Cables	•	•	•
	OD-DEVNET-IN	DeviceNET External Gateway & Cables	•	•	•
	OPT-2-ETHEG-IN	EtherNet Module	•	•	•
Communications Options	OPT-2-STICK-IN	Optistick with Bluetooth Interface	•	•	•
	OPT-2-USB-OBUS	USB PC Connection Kit	•	•	•
Encoder Feedback Interfaces	OPT-2-ENCHT-IN	Incremental Encoder Feedback Plug In Option Module (12 - 30Volt)		•	
	OPT-2-ENCOD-IN	Incremental Encoder Feedback Plug In Option Module (5Volt)		•	
External EMC Filters	OPT-2-E1010-20	Optifilter EMC Input Filter, 1 Phase, 10 Amp, IP20	•	•	•
	OPT-2-E3006-20	Optifilter EMC Input Filter, 3 Phase, 6 Amp, IP20	•	•	•
	OPT-2-E1025-20	Optifilter EMC Input Filter, 1 Phase, 25 Amp, IP20	•	•	•
	OPT-2-E3016-20	Optifilter EMC Input Filter, 3 Phase, 16 Amp, IP20	•	•	•
	OPT-2-E3025-20	Optifilter EMC Input Filter, 3 Phase, 25 Amp, IP20	•	•	•
	OPT-2-E3050-20	Optifilter EMC Input Filter, 3 Phase, 50 Amp, IP20	•	•	•
	OPT-2-E3080-20	Optifilter EMC Input Filter, 3 Phase, 80 Amp, IP20	•	•	•
	OPT-2-E3180-20	Optifilter EMC Input Filter, 3 Phase, 180 Amp, IP20	•	•	•
	OPT-2-E3300-00	Optifilter EMC Input Filter, 3 Phase, 300 Amp, IP00	•	•	•
	External EMC Filters IP66	OPT-2-E1010-66	Optifilter EMC Input Filter, 1 Phase, 10 Amp, IP66	•	•
OPT-2-E3006-66		Optifilter EMC Input Filter, 3 Phase, 6 Amp, IP66	•	•	•
OPT-2-E1025-66		Optifilter EMC Input Filter, 1 Phase, 25 Amp, IP66	•	•	•
OPT-2-E3016-66		Optifilter EMC Input Filter, 3 Phase, 16 Amp, IP66	•	•	•
OPT-2-E3025-66		Optifilter EMC Input Filter, 3 Phase, 25 Amp, IP66	•	•	•
Frame Size 8 Accessories	OPT-2-L31500-00	Frame Size 8 AC Line Choke 500A, 1%		•	
	OPT-2-M3500-00	Frame Size 8 Output Choke 500A		•	
	OPT-2-L3500-00	Frame Size 8 AC Line Choke 500A, 4%		•	
	OPT-2-E3500-00	Frame Size 8 EMC Filter		•	
I/O Options	ODP-2ROUT-IN	Dual Relay Output Card	•		
	OPT-HVACO-IN	HVACO Drive Running & Tripped Relay Output Card	•		
	OPT-2-CASCD-IN	Cascade Control Plug In Option Module		•	•
	OPT-2-EXTIO-IN	Extended I/O Plug In Option Module		•	•
	OPT-LOGIP-11	110V Logic Input Card	•		
	OPT-LOGIP-23	230V Logic Input Card	•		
	OPT-2-LOCMO-IN	Optidrive P2 / HVAC Local Mouse		•	•
OPT-2-CANIO-IN	External Remote I/O Interface		•		
Input Chokes	OPT-2-L1016-20	Input Choke, 1 Phase, 16 Amp, IP20	•	•	•
	OPT-2-L1025-20	Input Choke, 1 Phase, 25 Amp, IP20	•	•	•
	OPT-2-L3006-20	Input Choke, 3 Phase, 6 Amp, IP20	•	•	•
	OPT-2-L3010-20	Input Choke, 3 Phase, 10 Amp, IP20	•	•	•
	OPT-2-L3036-20	Input Choke, 3 Phase, 36 Amp, IP20	•	•	•
	OPT-2-L3050-20	Input Choke, 3 Phase, 50 Amp, IP20	•	•	•
	OPT-2-L3090-20	Input Choke, 3 Phase, 90 Amp, IP20	•	•	•
	OPT-2-L3200-00	Input Choke, 3 Phase, 200 Amp, IP00	•	•	•
	OPT-2-L3300-00	Input Choke, 3 Phase, 300 Amp, IP00	•	•	•
	Input Chokes IP66	OPT-2-L1016-66	Input Choke, 1 Phase, 16 Amp, IP66	•	•
OPT-2-L1025-66		Input Choke, 1 Phase, 25 Amp, IP66	•	•	•
OPT-2-L3006-66		Input Choke, 3 Phase, 6 Amp, IP66	•	•	•
OPT-2-L3010-66		Input Choke, 3 Phase, 10 Amp, IP66	•	•	•
OPT-2-L3018-66		Input Choke, 3 Phase, 18 Amp, IP66	•	•	•
Local Isolator	OPT-2-ISOLO-S4	Local Isolator, Frame Size 4		•	•
	OPT-2-ISOLO-S5	Local Isolator, Frame Size 5		•	•
Output Filters	OPT-2-M3008-20	Output Filter, 8 Amp, IP20	•	•	•
	OPT-2-M3012-20	Output Filter, 12 Amp, IP20	•	•	•
	OPT-2-M3030-20	Output Filter, 30 Amp, IP20	•	•	•
	OPT-2-M3180-00	Output Filter, 180 Amp, IP20	•	•	•
	OPT-2-M3075-20	Output Filter, 75 Amp, IP20	•	•	•
	OPT-2-M3300-00	Output Filter, 300 Amp, IP00	•	•	•
Output Filters IP66	OPT-2-M3008-66	Output Filter, 8 Amp, IP66	•	•	•
	OPT-2-M3012-66	Output Filter, 12 Amp, IP66	•	•	•
	OPT-2-M3018-66	Output Filter, 18 Amp, IP66	•	•	•
PLC Licence	OPT-STUDIO-IN	Optitools Studio PLC Function Single PC Licence		•	•
Remote Keypads	OPT-2-OPORT-IN	Optiport 2 with RJ45 Cable	•	•	•
	OPT-2-OPPAD-IN	Optipad Remote OLED Keypad with RJ45 Cable	•	•	•
	OPT-2-OPDTK-IN	Optipad Remote OLED Keypad with RJ45 Cable (Turkish)	•	•	•
RJ45 Accessories	OPT-J4505-IN	RS485 Data Cable, 0.5M RJ45	•	•	•
	OPT-J4510-IN	RS485 Data Cable, 1.0M RJ45	•	•	•
	OPT-J4530-IN	RS485 Data Cable, 3.0M RJ45	•	•	•
	OPT-J45SP-IN	RS485 3 Way Data Cable Splitter RJ45	•	•	•
	OPT-3-BNTSP-IN	RJ45 BacNet connector			•
	OPT-2-RJHUB-IN	RS485 8 Way Network Hub RJ45	•	•	•
	OPT-2-RJTRM-IN	RJ45 Terminator	•	•	•
Through Hole Mount Kits	OPT-2-THMT04	Through Hole Mount Kit Frame Size 4		•	•
	OPT-2-THMT05	Through Hole Mount Kit Frame Size 5		•	•
	OPT-2-THMT06	Through Hole Mount Kit Frame Size 6		•	•
	OPT-2-THMT07	Through Hole Mount Kit Frame Size 7		•	•

Inverterk Drives Ltd is dedicated to the design, manufacture and marketing of electronic variable speed drives. The state of the art UK headquarters houses specialist facilities for research & development, manufacturing and global marketing. The company pledges to implement and operate the ISO 14001 Environmental Management System to enhance environmental performance.

All company operations are accredited to the exacting customer focused ISO 9001:2008 quality standard. The company's products are sold globally in over 80 different countries. Inverterk Drives' unique and innovative drives are designed for ease of use and meet with recognised international design standards.



UK Headquarters, Welshpool

Global Drive Solutions

Inverterk Drives operate at the heart of automated systems around the world



Crane Control

Demanding application at South African mine



Machine Tool OEM

UK machine tool supplier specifies Optidrive



Manufacturing

IP66 washdown duty drives in Singapore



Food Processing

Precision conveyor control in Spain



Amusement Parks

Reliable control of difficult loads in Spain

Inverterk Drives Ltd adopts a policy of continuous improvement and whilst every effort has been made to provide accurate and up to date information, the information contained in this catalogue should be used for guidance purposes only and does not form part of any contract.

No part of this catalogue may be reproduced or transmitted in any form or by any means, electrical or mechanical including photocopying, recording or by any other form of information storage or retrieval system without permission in writing from the publisher.

www.inverterkdrives.com

INVERTEK DRIVES LIMITED UK Headquarters

Offa's Dyke Business Park
Welshpool, Powys, UK
SY21 8JF

Tel: +44 (0)1938 556868
Fax: +44 (0)1938 556869
Email: sales@inverterkdrives.com

