



# UniOP User's Manual

Updated for Designer 6.06

Sitek S.p.A.  
Tn179-05  
Ver. 1.00

---

**Copyright © 2007 Sitek S.p.A. – Verona, Italy**

Subject to change without notice

The information contained in this document is provided for informational purposes only. While efforts were made to verify the accuracy of the information contained in this documentation, it is provided “as is” without warranty of any kind.

Third-party brands and names are the property of their respective owners.

[www.exor-rd.com](http://www.exor-rd.com)

## Table Of Contents

1	Welcome .....	7
2	Quick Start.....	2
	2.1 Quick Start Tutorial Introduction.....	2
	2.1.1 Development Environment Setup .....	2
	2.2 Quick Start Tutorial .....	3
3	Installation .....	9
	3.1 Overview.....	9
	3.2 Assumptions .....	9
	3.3 Conventions.....	9
	3.4 System Requirements.....	10
	3.4.1 Free hard disk space .....	10
	3.4.2 RAM Memory.....	10
	3.4.3 Supported Operating Systems:.....	10
	3.5 Software Installation.....	10
	3.6 Connecting the Panel to the PC.....	12
	3.7 How to Report a Bug.....	13
	3.8 Technical Support.....	13
	3.9 Contact Information.....	13
	3.10 Designer Software License .....	14
	3.10.1 SOFTWARE LICENSE .....	14
	3.10.2 Grant of License .....	14
	3.10.3 Limitations .....	14
	3.10.4 COPYRIGHT .....	15
	3.10.5 INTELLECTUAL PROPERTY .....	15
	3.10.6 DISCLAIMER (Limited Warranty).....	15
4	Reference.....	15
	4.1 File Menu.....	15
	4.1.1 File Menu.....	15
	4.1.2 New .....	16
	4.1.3 Open.....	17
	4.1.4 Close .....	17
	4.1.5 Save .....	17
	4.1.6 Save As .....	17
	4.1.7 Print .....	18
	4.1.8 Print Preview.....	18
	4.1.9 Designer Print Setup.....	18
	4.1.10 Export to tag database.....	21
	4.1.11 Export Strings .....	21
	4.1.12 Import Strings .....	23
	4.1.13 Recent Files.....	24
	4.1.14 Exit.....	24
	4.2 Edit Menu .....	24
	4.2.1 Edit Menu .....	24
	4.2.2 Undo .....	24
	4.2.3 Redo .....	24
	4.2.4 Cut.....	24
	4.2.5 Copy .....	25
	4.2.6 Paste .....	25
	4.2.7 Select All.....	25
	4.2.8 Align.....	25
	4.2.16 Make Same Size.....	26
	4.2.21 Fonts.....	27
	4.3 View Menu .....	30
	4.3.1 View Menu.....	30

4.3.2	Zoom In .....	30
4.3.3	Zoom Out.....	31
4.3.4	Status Bar.....	31
4.3.5	Toolbars.....	32
4.3.8	Workspace.....	34
4.3.9	Full Screen.....	34
4.3.10	Graphics Library .....	35
4.3.15	Layers.....	38
4.4	Insert Menu.....	41
4.4.1	Insert Menu.....	41
4.4.2	Text.....	42
4.4.3	Bitmap .....	42
4.4.4	Data Fields.....	44
4.4.85	Touch Cells.....	104
4.4.162	Shapes .....	146
4.4.167	Trend Window.....	147
4.4.228	Meter Instrument.....	157
4.4.286	Trend Time Field.....	168
4.4.296	Recipe Menu.....	172
4.4.305	Special Characters .....	175
4.4.306	Import Bitmap Graphics .....	175
4.5	Page Menu .....	182
4.5.1	Page Menu .....	182
4.5.2	Insert Page .....	182
4.5.3	Add Page.....	182
4.5.4	Delete Page.....	182
4.5.5	Go to Page.....	183
4.5.6	Previous Page .....	183
4.5.7	Next Page.....	183
4.5.8	Page Options.....	183
4.5.14	Recipe Configuration .....	184
4.5.26	Special Pages and Page Modes.....	187
4.6	Project Menu.....	190
4.6.1	Project Menu.....	190
4.6.2	Configure Controller.....	190
4.6.19	Panel Setup .....	194
4.6.78	Network Setup .....	208
4.6.112	Panel Controller Interface .....	218
4.6.140	Report on Panel Printer .....	226
4.6.201	Passwords .....	240
4.6.215	Languages.....	246
4.6.224	Next Language .....	248
4.6.225	Configure Tag Dictionaries .....	248
4.6.231	Tag Validation.....	250
4.6.232	Trend Buffers .....	250
4.6.266	Memory Use .....	257
4.6.267	Time Scheduled Triggers.....	257
4.7	Transfers Menu.....	261
4.7.1	Transfers Menu.....	261
4.7.2	Download.....	262
4.7.3	Upload .....	263
4.7.4	Download to SSFDC.....	263
4.7.10	Options .....	266
4.7.44	Get Panel Resources.....	274
4.7.45	Check Firmware Versions.....	275
4.7.46	Switch to Operation mode.....	276
4.7.47	Switch to Configuration mode .....	276
4.7.48	Remote Passthrough .....	276
4.7.53	Dial .....	277
4.7.54	Hang Up .....	278

4.8	Tools Menu .....	278
4.8.1	Tools Menu .....	278
4.8.2	Tag Editor .....	278
4.8.66	Font Editor .....	297
4.8.94	Keypad Designer .....	306
4.8.139	Customize.....	323
4.8.165	Options .....	333
4.8.176	Advanced.....	336
4.8.185	Replace Images.....	339
4.9	Window Menu .....	340
4.9.1	Window Menu .....	340
4.9.2	New Window.....	341
4.9.3	Cascade .....	341
4.9.4	Tile Horizontally .....	341
4.9.5	Tile Vertically .....	341
4.10	Application Menu .....	341
4.10.1	Application Menu .....	341
4.10.2	Restore .....	341
4.10.3	Move.....	342
4.10.4	Size.....	342
4.10.5	Minimize .....	342
4.10.6	Maximize .....	342
4.10.7	Close .....	342
5	Workspace .....	342
5.1	Workspace.....	342
5.2	Graphics .....	344
5.3	Objects .....	345
5.4	Project .....	346
5.4.1	Project .....	346
5.4.2	Data Transfer.....	346
6	Basics.....	348
6.1	Basics .....	348
6.2	Designer Screen .....	348
6.2.1	Designer Screen .....	348
6.2.2	Menu Bar .....	349
6.2.3	Toolbars.....	350
6.2.4	Workspace.....	352
6.2.5	Project Screen .....	352
6.2.6	Status Bar .....	353
6.2.7	Right-Click Menus.....	354
6.2.8	Tooltips .....	355
6.2.9	Getting Help.....	355
6.3	Designer Setup .....	355
6.3.1	Designer Setup .....	355
6.3.2	Transfer Settings .....	355
6.3.3	Controller Selection and Setup .....	356
6.3.7	Panel Selection and Setup.....	357
6.4	Creating a Project .....	359
6.4.1	Creating a Project .....	359
6.4.2	Creating a New File .....	359
6.4.3	Selecting a Font.....	360
6.4.4	Inserting Page Objects.....	360
6.4.5	Saving a Project File.....	360
6.4.6	Memory Used by the Project File .....	360
6.5	Printing .....	361
6.6	Project Upload and Download.....	361
6.7	Simple Data Fields.....	361
6.8	Simple Touch Cells.....	362
7	Advanced .....	363

7.1	Automatic Firmware Upgrade Procedure .....	363
7.1.1	Automatic Firmware Upgrade Procedure .....	363
7.1.2	Procedure to Upgrade the Internal Flash Memory .....	364
7.1.3	Check Firmware Versions .....	364
7.1.4	Designer Firmware Files Directory .....	366
7.1.5	FW Rescue Mode .....	366
7.2	Double Protocol .....	367
7.2.1	Double Protocol .....	367
7.2.2	Enabling Multiple-Protocol Configuration .....	368
7.2.3	Controllers Setup .....	370
7.2.4	Placing Fields on a Page .....	370
7.2.5	Downloading Uploading and Getting Panel Resources .....	372
7.2.6	Configuring UniNET Networks .....	372
7.3	Interlock Mailbox .....	373
7.3.1	Interlock Mailbox .....	373
7.3.2	Enabling the Internet Mailbox .....	374
7.3.6	Structure of the Mailbox .....	375
7.3.11	Interlock Mailbox Commands .....	377
7.3.35	Mailbox Programming .....	387
7.4	Networks .....	389
7.4.1	UniNET Networks .....	389
7.4.2	General Characteristics .....	390
7.4.7	Network Configurations .....	394
7.4.12	Network Types .....	397
7.4.20	Connecting Panels to the Network .....	400
7.4.34	Network Setup .....	406
7.4.39	Advanced Network Programming .....	407
7.4.47	Network Examples .....	412
7.5	Panel Fonts .....	416
7.5.1	Panel Fonts .....	416
7.5.2	Installing New Panel Fonts .....	417
7.5.8	Downloading Panel Fonts .....	418
7.5.9	Compressing Panel Fonts .....	419
7.6	Printing .....	420
7.6.1	Printing .....	420
7.6.2	Printer Setup .....	420
7.6.3	Reports .....	420
7.6.9	Printer Setup Example .....	422
7.7	RDA .....	423
7.7.1	RDA .....	423
7.7.2	Keyboard Update Area .....	425
7.7.3	Panel Status Area .....	426
7.7.23	Controller Update Area .....	429
7.8	Recipes .....	433
7.8.1	Recipes .....	433
7.8.2	Working with Recipes .....	434
7.8.3	Inserting Recipe Data Fields .....	434
7.8.4	Configuring Recipe Parameter Sets .....	434
7.8.5	Recipes and Control Variables .....	435
7.8.14	Recipes and the Keyboard Macro Editor .....	441
7.8.15	Recipe Menu .....	441
7.8.25	Recipes and the Interlock Mailbox .....	445
7.8.26	Multipage Recipe Support .....	445
7.8.31	Recipes and Events Backup in Flash .....	447
7.8.34	Recipe Example .....	449
7.9	Tags .....	454
7.9.1	Tags .....	454
7.9.2	Tag Dictionaries .....	455
7.9.6	Tag Editor .....	456
7.9.11	Using Tags in Designer .....	458

7.9.12	Tag Validation.....	458
7.9.15	Tag Example.....	459
7.10	Trends .....	461
7.10.1	Trends .....	461
7.10.2	Trend Buffer.....	462
7.10.9	Trend Window.....	464
7.10.17	Internal Panel Control Variables .....	467
7.10.18	Trend Macros.....	467
7.10.19	Trend Printing .....	467
7.10.20	Mailbox .....	467
7.10.21	Trend Limitations .....	468
7.11	Working with Graphics .....	468
7.11.1	Working with Graphics .....	468
7.11.2	Simple Shapes.....	469
7.11.3	Graphics Libraries.....	470
7.11.4	Objects Libraries .....	472
7.11.5	Color Boxes .....	474
7.12	Ethernet Connectivity.....	475
7.12.1	Assigning IP Address to Panel.....	475
7.12.10	Selecting Ethernet Communication in Designer .....	479
7.12.11	Pick Panel: The Ethernet Control Panel.....	480
7.12.15	Clock Synchronization with the SNTP Protocol.....	482
7.12.16	Using UniDataExchange.....	483
7.12.23	Basic Ethernet Diagnostic with Ping .....	486
7.13	Getting Started with B Series Panels .....	486
7.13.1	The New Hardware Platform for UniOP Panels .....	486
7.13.3	Support for 64K Colors .....	487
7.13.4	The FW60 Memory Architecture .....	487
7.13.5	The Internal Memory.....	488
7.13.7	Video Input Option .....	490
7.13.13	Backlight Dimming .....	496
7.13.14	Compatibility Issues.....	497
8	Index.....	498

## 1 Welcome

Developing applications for a UniOP panel is quick and painless when using Designer software. The common functionality found among many Windows™ applications can also be found in Designer. This familiar interface style helps new users to quickly learn the Designer software.

A completed project file of format \*.dpr contains all the information needed to display your page images and controller data values in the formats you selected while creating your project file. The panel hardware will handle all of the underlying communications necessary to transfer data to and from the controller, leaving you free to concentrate on the appearance and functionality of your data and display pages.

Note: Depending on the particular configuration of your project, one or more additional files may be necessary to convey all the necessary information about a project. These additional files may contain information about Keypad Designer, UniSSFDC, Font Editor, Nice Font Editor, etc. The project file itself may, in certain cases, not be sufficient to contain all the information necessary to reproduce the application.

Designer makes it possible to work in a natural and intuitive way using the logic behind your control application to guide you through development. You can use Designer to create one

or more display pages that outline and control your applications. The multiple page capability of each panel allows any application to be broken down into as many pages as you want, depending only on the amount of memory in your target system. Completed projects can be recalled from disk or from the panel itself for further modification.

For information regarding hardware operation, please see the UniOP Installation & Operation Guide

(Internal Manual Code: 05.011)

## 2 Quick Start

### 2.1 Quick Start Tutorial Introduction

The Quick Start Tutorial shows how the Designer software is used to develop applications for the UniOP panel.

Though the chosen example is very simple, it goes through all the steps that are normally used to develop normal applications, even the most complex ones.

At the end of the tutorial you will not be able to perform the single steps in detail, you will not know all the Designer features, how and when to use them. What you will have is a general feeling of what is required to develop an application, which tasks have to be performed and how easy is their execution thanks to the Designer software.

Note: The tutorial assumes that you have already installed the software.

#### 2.1.1 Development Environment Setup

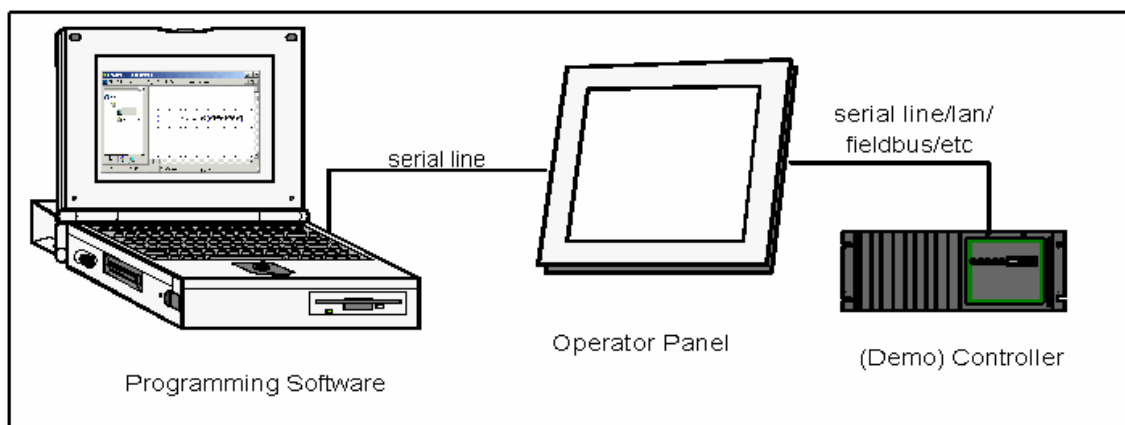

The above figure shows a typical, complete setup for the development of applications.



Users develop their applications with the Designer software and download them into the UniOP panel. The panel in turn is connected to one or more Controllers (PLCs).

The developed applications can display the Controller(s) I/Os on the UniOP panel and also can send commands to the connected Controller(s).

The UniOP contains a software simulated Demo Controller that allows the development and testing of applications even when real Controllers are not available.

To the Quick Start Tutorial

## 2.2 Quick Start Tutorial

Connect the programming cable from the PC to the panel.

Connect the controller's communication cable to the panel.

Locate the Designer icon on your PC desktop and click on it.



Once the Designer is open, create a new project file by selecting New from the File menu.

Give the new project a name, select a file location,

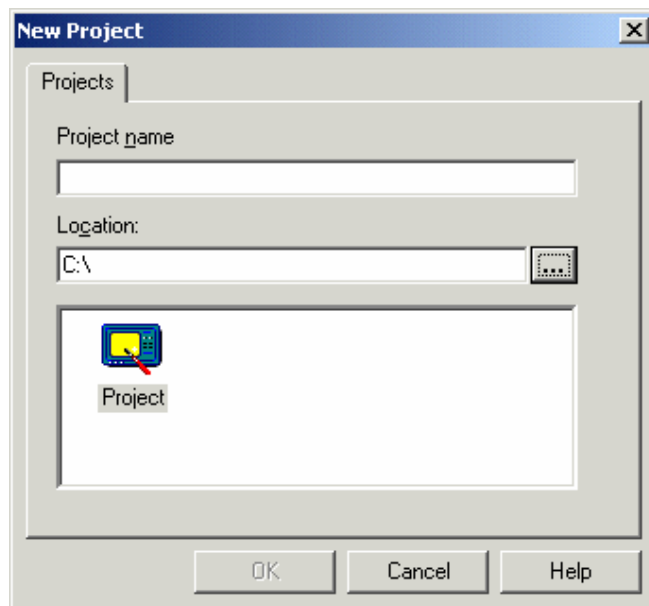

and click OK.

Select Project - Configure Controller.

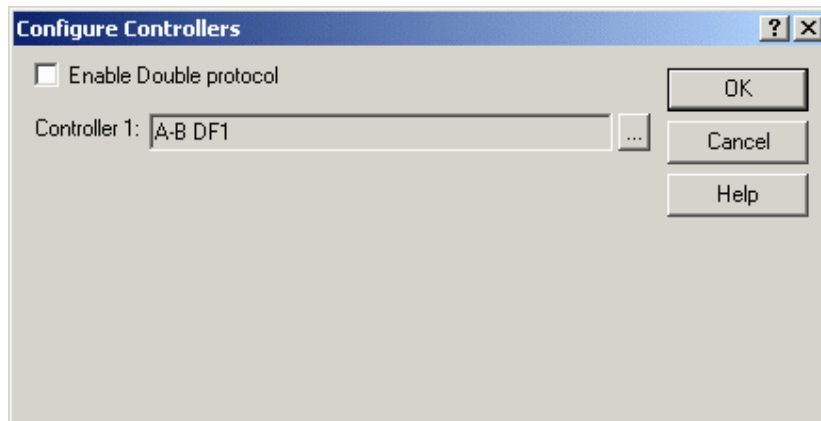

The currently selected controller is displayed.

Click on the "..." button to select a different driver, if necessary.

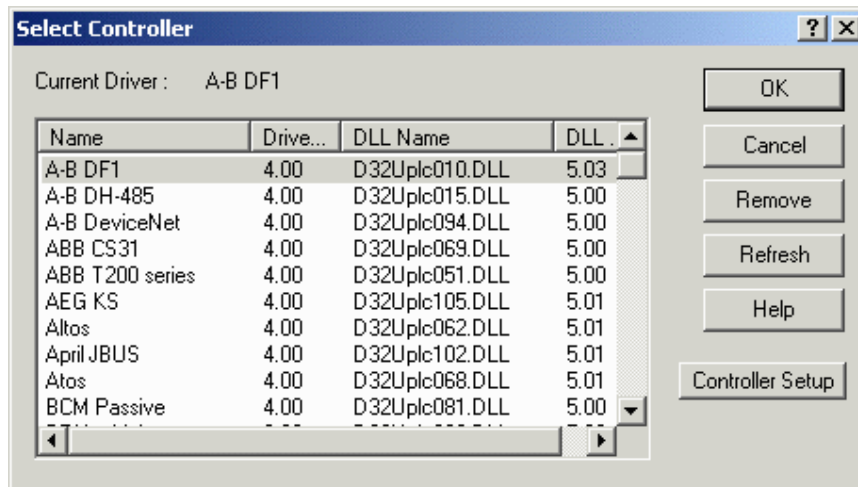

Press the Controller Setup button to select the particular controller model being used.

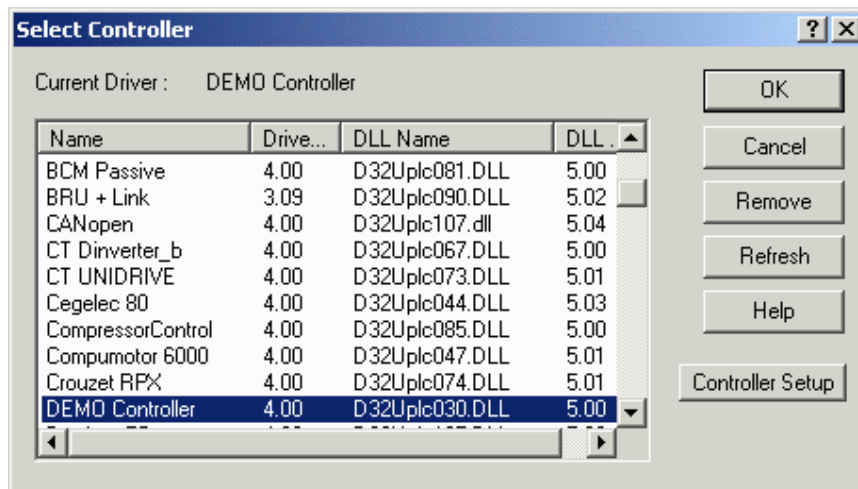

If required, set up the panel-to-controller communication parameters by pressing the PLC/Drive Comm button.

Set the parameters, then click on OK to confirm your selections and close the open dialog boxes.

Select Project - Panel Setup. Select the type of display representative of your UniOP panel.

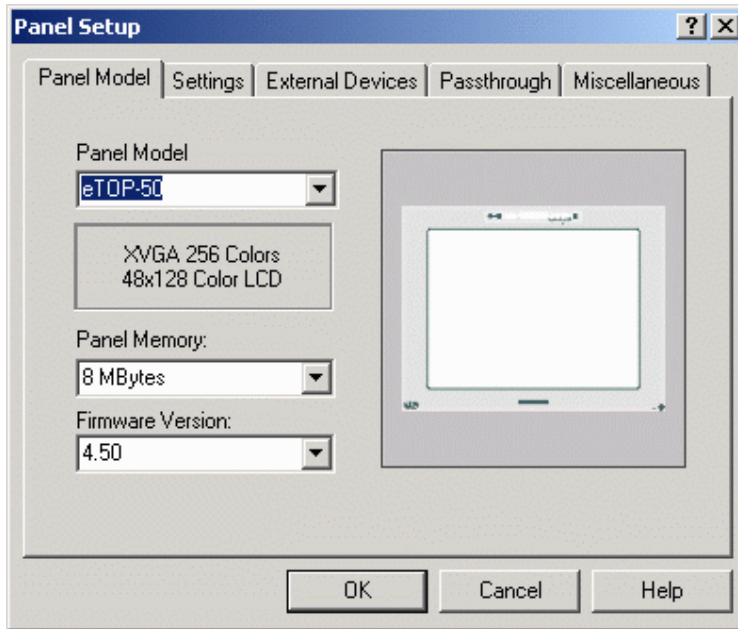

This step could be eliminated by placing the panel in Configuration Mode and selecting Get Panel Resources from the Transfers menu.

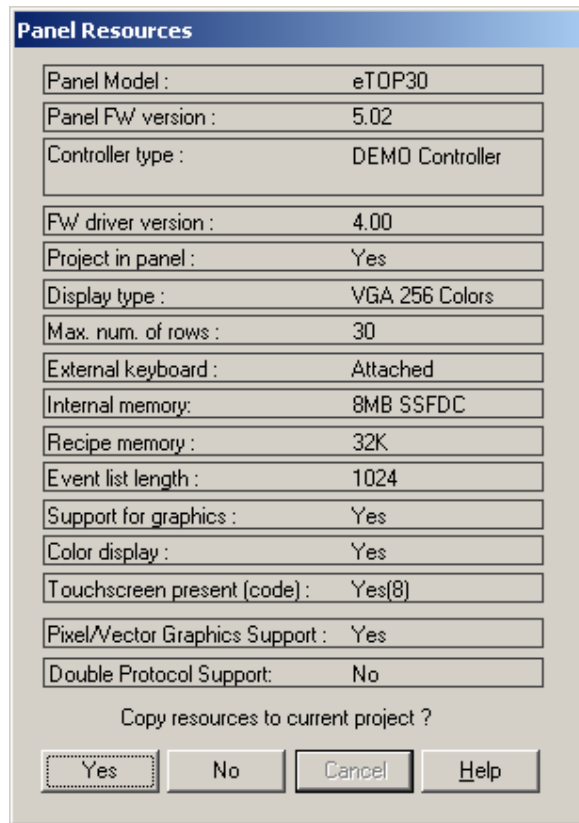

You are now ready to begin designing the project page. Click somewhere on the project page and, using the PC keyboard, type the words "This is a data value =" on the first page of the project.

Select Insert - Data Fields - Numeric/ASCII. The cursor will turn into crosshairs. Use the cursor to define the boundaries of a small box following the phrase you typed on the page.

The Properties dialog box will appear on the screen.

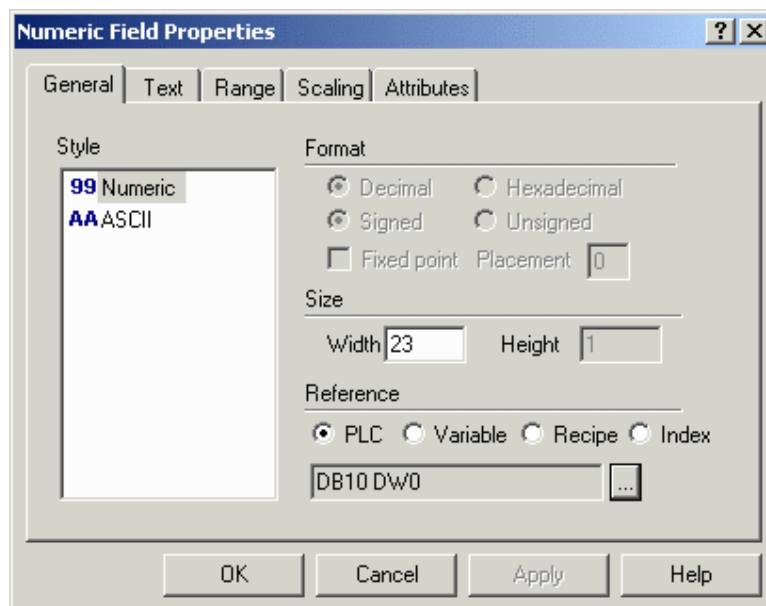

Click the "..." button under Reference.

The Data Field Properties dialog box will appear on the screen.

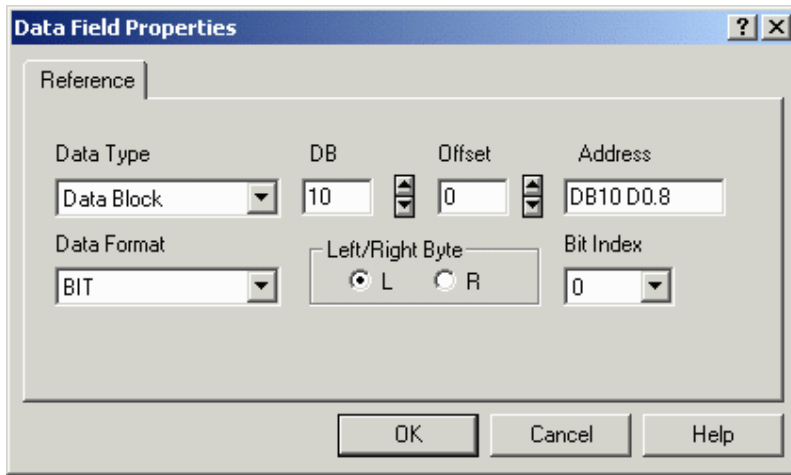

Fill in the Data Field Properties dialog box with the appropriate data. The data reference MUST already exist in the controller. Keep in mind that this dialog box is controller specific.

Click on the OK button in order to confirm the controller information.

Click on the OK button in order to confirm the numeric field properties and create the data field. The following figure shows the resulting screen.

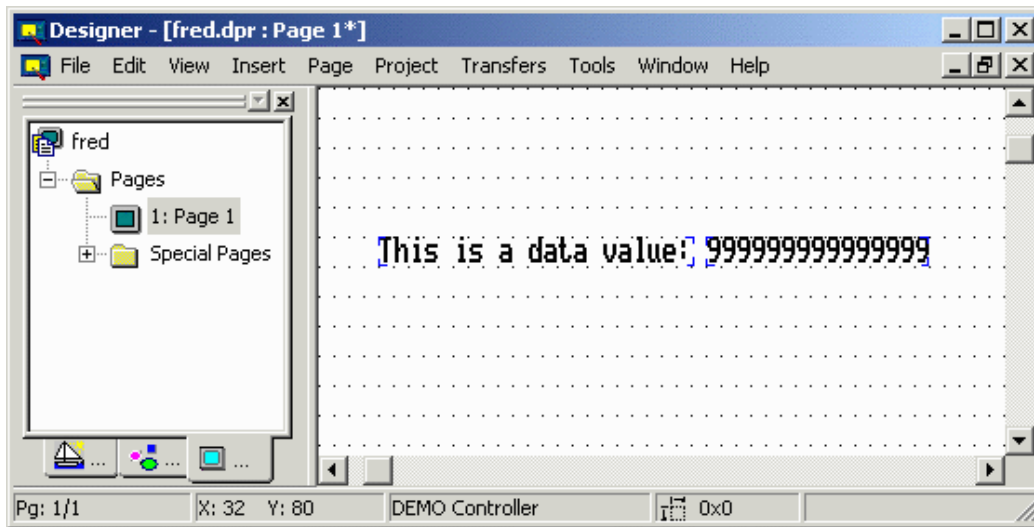

Select Save from the File menu.

Select Transfers - Options - Serial Ports

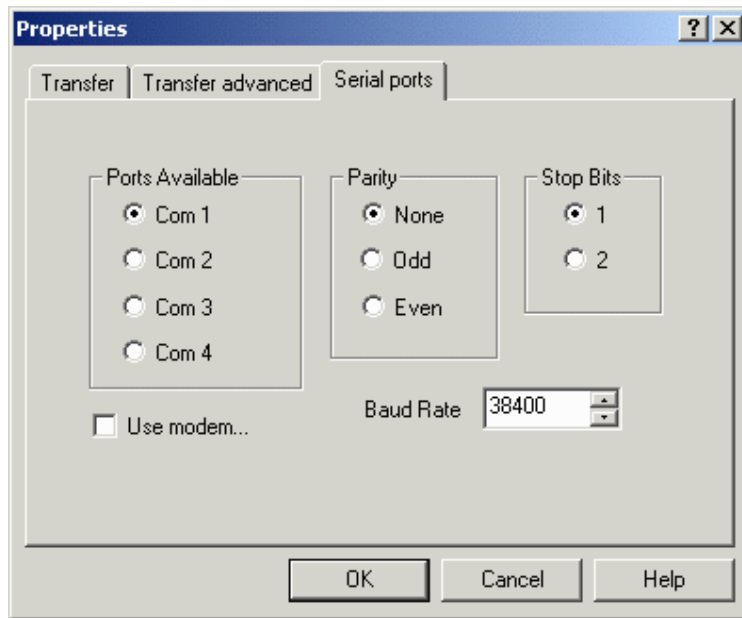

Choose the communications port that Designer will use to communicate with the panel. Ports that are unavailable will be grayed out. Under normal circumstances, use the following parameters to communicate with a panel: 38400 baud, no parity, and 1 stop bit.

Power up the UniOP panel and make sure it is in Configuration Mode. The panel must be in Configuration Mode to communicate with the Designer software! When the unit is in Configuration Mode, the words CONFIGURATION MODE will appear on the panel. If you do not see the words CONFIGURATION MODE displayed on the panel:

Hold down the Enter key or touch an empty spot on the screen until the command menu appears.

Use the arrow keys to highlight CONFIG or CFG and press Enter again.

Select Transfers - Download from Designer to send the project to the panel.

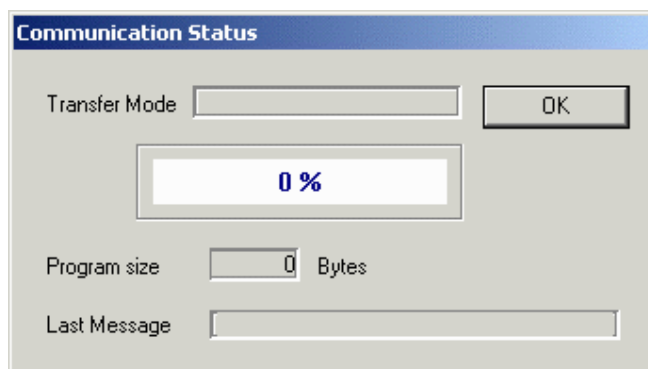

If the default setup of the Designer software has not been changed, the project will start automatically after being downloaded.

After a short pause, check the display:

The text that was typed in previous step should be visible, along with the data value read from the controller.

The Fault light should be off.

The Com and Run lights (if present) should be on. A blinking Com light indicates a communications error.

## **3 Installation**

### **3.1 Overview**

This section provides:

the assumptions and conventions used in this documentation,

system requirements for using Designer,

software installation instructions,

instructions for solving installation problems,

basic instructions for connecting a UniOP panel to the PC,

contact information,

technical support contacts,

instructions for reporting a bug,

software license and disclaimer.

### **3.2 Assumptions**

We assume that those reading this manual are using the Designer software to design control panel applications to run on UniOP panels.

We also assume that you have a basic understanding of PCs, Microsoft Windows™, and the type of network environment in which you will run the application.

### **3.3 Conventions**

Names of menus and commands on menus are shown in bold type, as are the names of dialog boxes. For example, "A new project may be created by selecting **New** from the **File**

menu." If the name of the command or menu is highlighted, it is linked to another topic in the help text. For example, "Select Get Panel Resources from the Transfers menu."

Keyboard keys that you should press are shown in bold, as in "Press Enter." If two keyboard keys are to be pressed at the same time, they are shown in bold with a plus sign (+) between them, as in "Press Ctrl+F2."

Text that you are to type into a box appears in bold in a different font (Courier), for example, "Type D:\setup in the box."

## **3.4 System Requirements**

The following hardware / software is required to use Designer.

### **3.4.1 Free hard disk space**

Designer, once installed, takes around 70 MB of hard disk space. The installation procedure (only at installation time) requires twice as much (i.e. 140 MB).

### **3.4.2 RAM Memory**

Designer runs on systems with at least 32 MB RAM memory.

### **3.4.3 Supported Operating Systems:**

Windows 98<sup>TM</sup> SE

Windows NT<sup>TM</sup> version 3.51 and above

Windows ME<sup>TM</sup>

Windows 2000<sup>TM</sup>

Windows XP<sup>TM</sup>

## **3.5 Software Installation**

Note: Microsoft Windows<sup>TM</sup> must be installed before installing the Designer software.

To install Designer:

Close all other programs.

Insert the CD-ROM into CD-ROM drive. If your system has Autorun enabled, the Designer installation will start automatically. If so, skip to step 5.



Click on the Start button and select Run from the popup menu.

Type D:\setup in the box (if your CD-ROM drive is not drive D, substitute the appropriate letter).

Follow the on screen prompts.

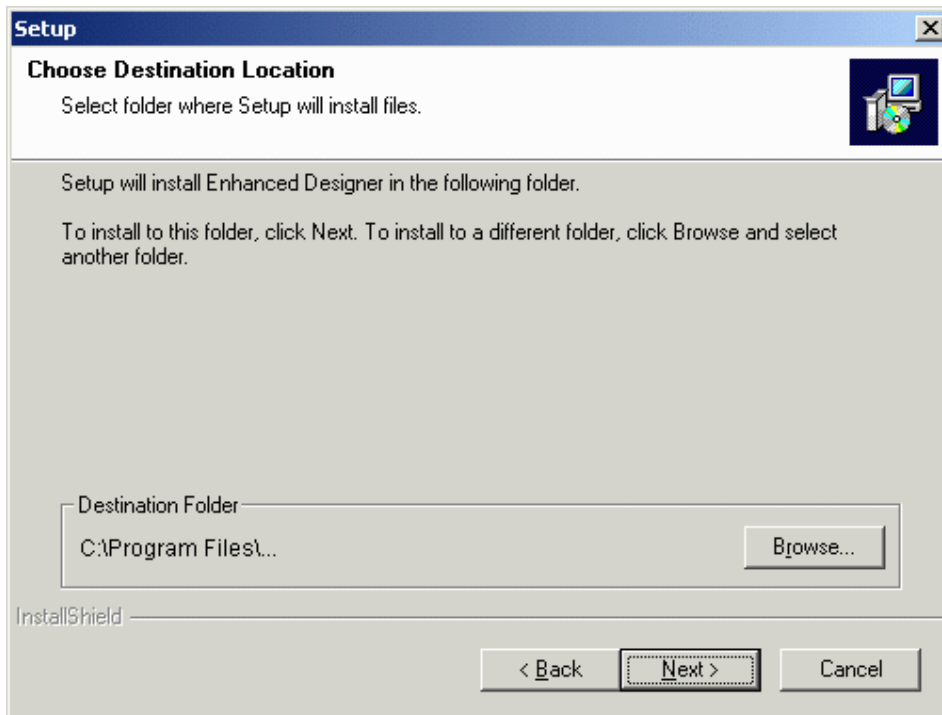

The default location for the Designer software is "c:\Program Files\Exor\Designer 6". If you prefer to have the software at a different location on your hard drive, you have that option.

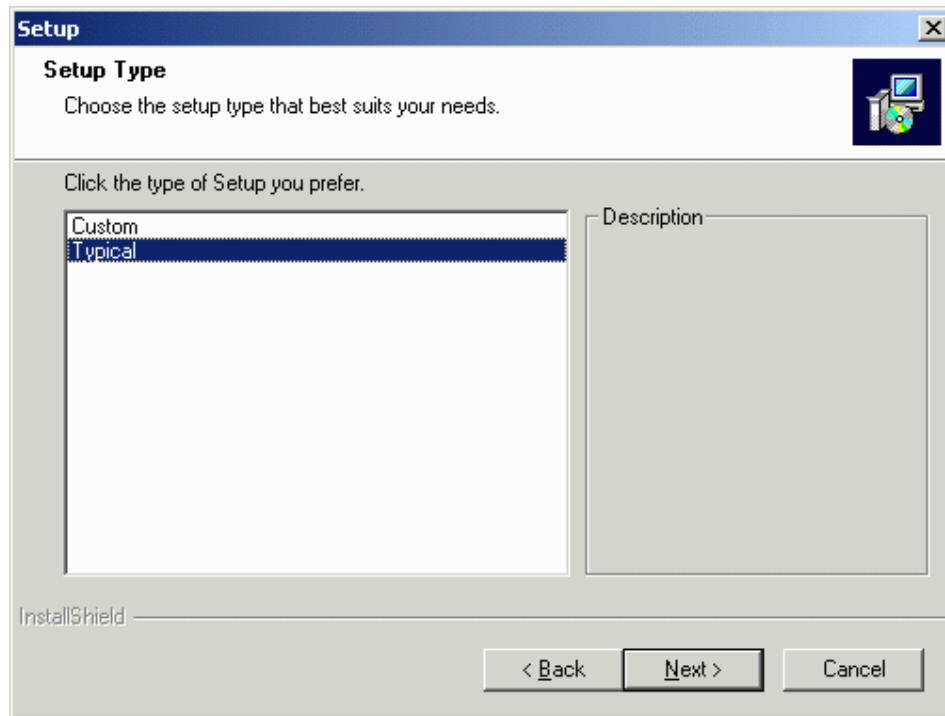

There are two types of setup available with the Designer software. They are:

**Typical** - The Designer software is installed with the most common options. This is recommended for most users.

**Custom** - You may choose the options that you want to install. This is recommended for advanced users.

The installation procedure will create a program group entitled "Designer" within Windows™. A Designer icon will be added to your desktop. Designer also appears on the Windows™ start menu under Start-Programs-Designer.

### 3.6 Connecting the Panel to the PC

Your UniOP panel should be set up according to the instructions in the UniOP Installation & Operation Guide. However, most panels are quite simple to set up. General setup instructions include:

Place the panel on a stable surface.

Connect one end of an appropriate connection cable to the appropriate port on the panel.

Connect the other end of the connection cable to the appropriate port on the computer.

Connect one end of the power cable to the panel.

Connect the other end of the power cable to the power source.

If the panel was never programmed before, it should power up in Configuration Mode.

See Panel Setup for information on how to initialize and set up the panel.

### **3.7 How to Report a Bug**

The Designer development team is proud to present a high quality program with minimal bugs. Despite their best efforts, however, bugs do occasionally appear in the software. Should you notice a problem with the software that you think may be a bug, please report it to:

techsupp@exorinternational.net

Please include as much information as possible, including a description of the irregularity, the type of PC and panel that you have, any other software that was running when the problem occurred, and the sequence of steps that led to the problem.

### **3.8 Technical Support**

For questions about the Designer software, contact EXOR by sending an email to the following address:

techsupp@exorinternational.net

### **3.9 Contact Information**

EXOR world-wide locations are listed hereafter:

EXOR Electronic R&D Inc.  
10150 International Blvd.  
Cincinnati, OH 45246  
USA  
<http://www.exor-rd.com>

EXOR GmbH  
Haus Grünewald 1  
42653 Solingen  
Germany  
<http://www.exor.de>

Sitek SpA  
Via Monte Fiorino 9  
San Giovanni Lupatoto (VR)  
I-37057  
Italy  
techsupp@sitek.it

### **3.10 Designer Software License**

This is a legal agreement between you (either an individual or a single entity) and EXOR for the Designer SOFTWARE, which includes computer software and may include associated media, printed materials, and "on-line" electronic documentation.

By installing, copying, downloading, accessing, or otherwise using the Designer SOFTWARE, you agree to be bound by the terms of this License. If you do not agree to the terms of this agreement, do not install or use the Designer SOFTWARE; you may, however, return it to your place of purchase for a full refund.

#### **3.10.1 SOFTWARE LICENSE**

The Designer SOFTWARE is protected by copyright laws and international copyright treaties, as well as other intellectual property laws and treaties. The Designer SOFTWARE is licensed, not sold.

#### **3.10.2 Grant of License**

With this License EXOR grants you the non-exclusive right to use the Designer SOFTWARE in accordance with the following terms:

You may install, use, access, display, run, or otherwise interact with ("RUN") one copy of the Designer SOFTWARE on a single computer, workstation ("COMPUTER"). The primary user of the COMPUTER on which the Designer SOFTWARE is installed may make a second copy for his or her exclusive use on a portable computer.

You may also store or install a copy of the Designer SOFTWARE on a storage device, such as a network server, used only to RUN the Designer SOFTWARE on your other COMPUTERS over an internal network; however, you must acquire and dedicate a license for each separate COMPUTER on which the Designer SOFTWARE is RUN from the storage device. A license for the Designer SOFTWARE may not be shared or used concurrently on different COMPUTERS.

The initial licensee of the of the Designer SOFTWARE may make a one-time permanent transfer of this License and the Designer SOFTWARE only directly to an end user. This transfer must include all of the Designer SOFTWARE (including all component parts, the media and printed materials and this License). The transferee of such one-time transfer must agree to comply with the terms of this License, including the obligation not to further transfer this License and the Designer SOFTWARE .

#### **3.10.3 Limitations**

You may not reverse engineer, decompile, or disassemble the Designer SOFTWARE, except and only the extent that such activity is expressly permitted by applicable law notwithstanding this limitation.

The Designer SOFTWARE is licensed as a single product, its component parts may not be separated for use on more than one COMPUTER.

### **3.10.4 COPYRIGHT**

All title and copyrights in and to the Designer SOFTWARE (including but not limited to any images, photographs, animations, video, audio, music and text incorporated into the Designer SOFTWARE), the accompanying printed materials, and any copies of the Designer are owned by EXOR or its suppliers. If this Designer SOFTWARE contains documentation which is provided only in electronic form, you may print one copy of such electronic documentation. You may not copy the printed materials accompanying the Designer SOFTWARE.

### **3.10.5 INTELLECTUAL PROPERTY**

The Intellectual Property of the Designer SOFTWARE (including but not limited to any images, photographs, animations, video, audio, music and text incorporated into the Designer SOFTWARE) is owned by EXOR.

### **3.10.6 DISCLAIMER (Limited Warranty)**

The Designer SOFTWARE is provided "as is" and without warranty of any kind, express, implied or otherwise, including without limitation, any warranty of merchantability or fitness for a particular purpose.

In no event shall EXOR be liable for any special, incidental, indirect or consequential damages of any kind, or any damages whatsoever resulting from loss of use, data or profits, whether or not advised of the possibility of damage, and on any theory of liability, arising out of or in connection with the use of the Designer SOFTWARE.

## **4 Reference**

### **4.1 File Menu**

#### **4.1.1 File Menu**

The File menu contains familiar Windows™ commands for managing files and printing.

New

Open

Close

Save

Save As

Print

Print Preview

Export to TagDB

Export Strings

Import Strings

Recent Files

Exit

#### 4.1.2 New

A new project may be created by selecting New from the File menu, by clicking the New File icon, or by pressing the Ctrl+N keys. This opens the New Project dialog box.

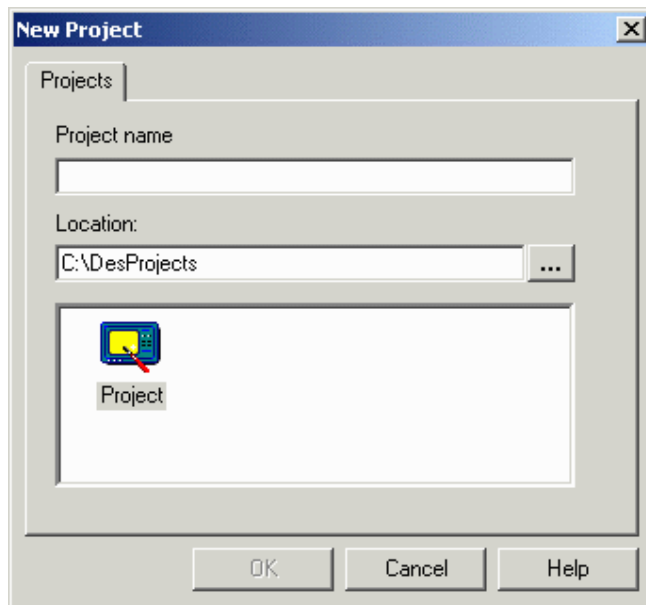

Enter a name for the new project and select the file location on the PC where the project file is to be stored. Click on an icon to identify the type of project file to be created. Unless otherwise specified, Designer files are assumed to have the .dpr extension.

When a new Project file is created, the current project configuration is carried over for use with the new project. This approach relieves you from having to reset the panel and controller parameters each time a new project is created. The latest configuration is saved on exit for use the next time Designer is started.

When you switch between two projects with different configurations, the latest project to be opened overrides the previous and becomes the new default state for the Designer.

To prevent accidental reset of the configuration parameters, you are prompted to confirm the New operation if there are pending modifications that have not been saved.

### 4.1.3 Open

To open an existing project, select Open from the File menu, click the Open icon on the toolbar, or press the Ctrl+O keys. The Open Project dialog box will appear, providing a list of the file names in each directory.

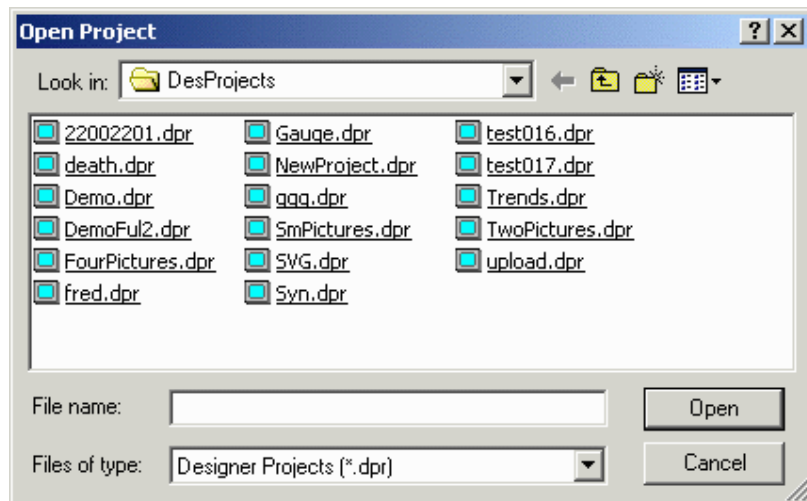

Enter the name of the file to be loaded or use the list box to select from the existing files. If an extension is not specified, .dpr is assumed.

### 4.1.4 Close

To close a currently open file, select Close from the File menu.

Files may also be closed by clicking on the lower of the two "X"s in the upper right-hand corner of the Designer window, by selecting Close from the Designer menu, or by pressing Ctrl+F4.

### 4.1.5 Save

To save a project, select Save from the File menu, click on the Save file icon on the toolbar, or press the Ctrl+S keys.

The cursor may be momentarily replaced with an hourglass while the file is saved.

If the application has not been named, the Save As dialog box will appear instead.

### 4.1.6 Save As

If an application to be saved has not been named, the Save Project As dialog box appears. Or, you may select Save As from the File menu. This option can also be used to save a project under a different name.

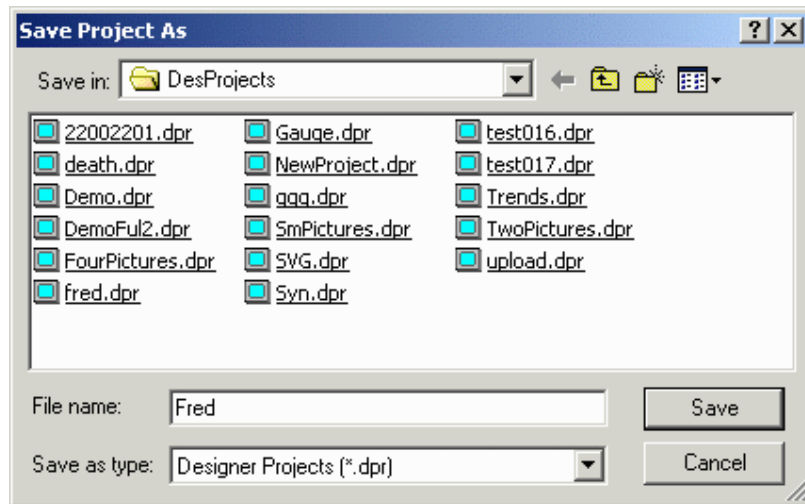

The Save Project As dialog box shows the current directory path and the current file name. A new name and path may be entered or the ones presented may be accepted.

Files may be saved as file format "\*.dpr" (Designer files) or "\*.rom" (Designer ROM files). If no extension is specified, "\*.dpr" is assumed.

If the file already exists in the selected directory, you are prompted to confirm the Save As operation in order to overwrite the existing file.

#### 4.1.7 Print

The Print command in the File menu refers to printing from the Designer software, whereas the print items in the Project menu are used to set up print functionality in the UniOP panels.

Selecting Print from the File menu (or pressing the Ctrl+P keys) brings up the Print Setup dialog box, from which the Designer project information may be printed.

#### 4.1.8 Print Preview

Selecting Print Preview from the File menu brings up the Print Setup dialog box, from which the Designer project information may be previewed for printing.

#### 4.1.9 Designer Print Setup

Designer contains a printing routine for printing project file information. This module is able to print graphical previews of the project pages, variable cross-references and much more!

Selecting File-Print or File-Print Preview will bring up the following dialog box.



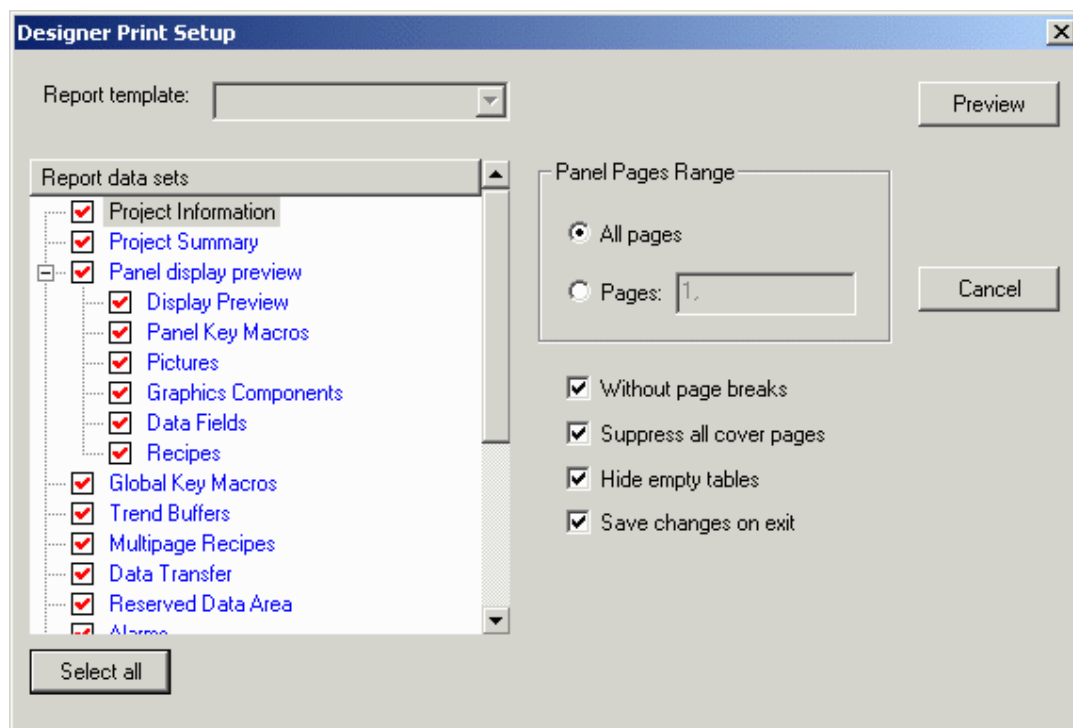

**Print (or Print Preview)**  
Start (or view) the print operation.

**Printer Setup**  
Open the standard Windows Printer Setup dialog box. Printer to use, page size, page orientation, etc. can be selected from this dialog box.

**Cancel**  
Close the dialog box without executing the print operation.

**Panel Page Range**  
Define which panel pages need to be included in the printout.

**All pages** All data on all panel pages are printed.  
**Pages** Only the data that is inside the selected pages are printed.  
 To specify the panel pages to print, the user needs to enter the page sequence to print. A page sequence is a page range separated by commas (i.e. 4-5, 8, 13-20). Valid ranges are a single page only, i.e. 8, or consecutive pages, i.e. 4-5.

**Without page breaks**  
Any new data section starts a new page. By selecting this checkbox, all data will be compressed on as little number of pages as possible.

**Suppress all cover pages**  
This checkbox should be selected if the user wants to suppress the cover pages.

**Hide empty tables**  
Use this checkbox if the user wants to avoid printing tables relative to data sections that were not configured inside the project.

## Save change on exit

When this checkbox is marked, the selected Report Data Set will be saved for future use.

## Report data sets

This section of the print dialog box contains the list of project data that could be printed. For any items that are listed, a checkbox gives the user the possibility to enable or disable the table printout.

## Project information

Generic project information. It contains the project name, panel type and name of the controller being used.

## Project Summary

Contains some statistical information such as the project file size, number of pages, number of used pictures, etc.

## UniOP page layout description data

List of page objects.

## UniOP Page description

Description of the pages in the project.

## Panel Key Macros

Local macro keys.

## Pictures

Static images.

## Touch Cells

List of graphic components: Object-oriented touch cells, Trends, Gauges.

## Data Fields

List of PLC data field items.

## Recipes

Recipe data set values.

## Global Key Macros

Global macro keys.

## Trend Buffers

Trend buffer parameters.

## Recipes

Table with list of recipes that have the Multipage flag set.

## Data Transfer

Data transfer jobs.

## Reserved Data Area

RDA parameters.

## Alarms

Alarm table with messages.

## Designer Setup

### Panel Printer and Reports

Printer setting and print report table parameters.

### Panel Setup

List of panel capabilities and setup configuration

### Controller and Network Setup

List of controller drivers connected on the panel network.

### Remote Pass through

Remote Pass through parameters.

### Password

Table with list of all defined passwords and their parameters.

### Cross Reference

List of Pages, Pictures and Controller references with page references.

### Report Contents

Table of the Report Contents with page numbers

## **4.1.10 Export to tag database**

This option is used to export all the tags defined in the currently opened project to a database specified by the user. If the project doesn't have any tags associated with it, this option will be disabled.

## **4.1.11 Export Strings**

Strings used in a project can be exported into a CSV (Comma Separated Values, a data format used by various applications, e.g. Microsoft Excel™) file by selecting Export Strings from the File menu.

This opens the Export Strings dialog box.

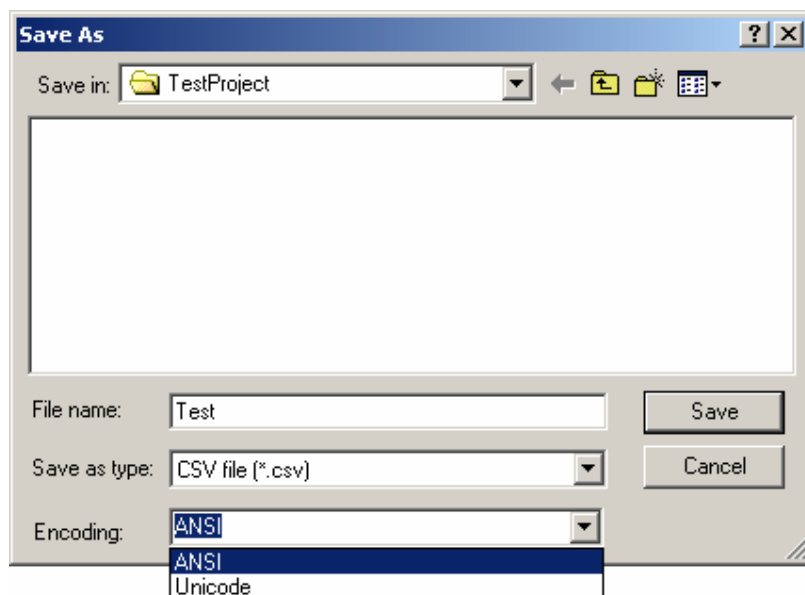

The information stored in the file has the following format:

```
#-----
# Filename: DemoFul2.csv
# Created: Friday, May 03, 2002 - 10:49
# Project: C:\Designer Projects\DemoFul2.dpr
#-----
2,""English - Default"",""French""
PG-1,""Main Menu"",""Menù Pri.""
ST-1-1,""Created by EXOR"",""Créé par EXOR""
ST-1-2,""UniOP Project Functionality"",""""
ST-1-3,""Tech Support Tel. ..."",""Tech Support Tel. ...""
```

The first section contains information about the exported file: its name, the date of creation and the original project file.

The second section specifies the number of languages and their names.

The third section contains a line for each string in the project. Each line contains a string identifier (not to be modified), then the string value for each one of the different languages supported by the project.

This way it is possible to modify the strings stored in a given project.

ANSI / Unicode Encoding is supported.

Using Unicode feature characters of different languages can be added in the projects page by editing the string value of the exported file.

#### Restrictions

Unicode character is defined using two bytes, this means we can have until 65.536 different characters. UniOP panel, instead, can manage 256 characters code. Using the Unicode feature you have the possibility to mapping a subset of 256 Unicode characters inside the UniOP panel.

## Typical application

To enable Unicode support it is necessary modify the panel font file to have some Unicode characters inside. For example you can use ANSI characters inside the first 128 bytes and Russian (Unicode) characters inside the other 128 bytes. Then you have to configure the new 2unicode parameter inside the display32.ini file to define the ANSI code (256) <-> UniCode (65.536) character correspondence. Example is shown below:

```
[RUSSO Font]
BargraphStart=226
BoxChars=218,191,192,217,196,179,196,179,180,194,193;201,187,200,188,205,186,205,186,0,0,0
BigCharStart=128
Linefeed=127
2Unicode=0x8F,0x0444;0x90,0x0438;0x91,0x0441;0x92,0x0432;
```

Note: Modifying the string length has an effect on the real state occupied by that string on the screen.

### 4.1.12 Import Strings

It is possible to upload to a project the strings previously saved in a CSV (Comma Separated Values, a data format used by various applications, e.g. Microsoft Excel™) file by selecting Import Strings from the File menu.

This opens the Import Strings dialog box.

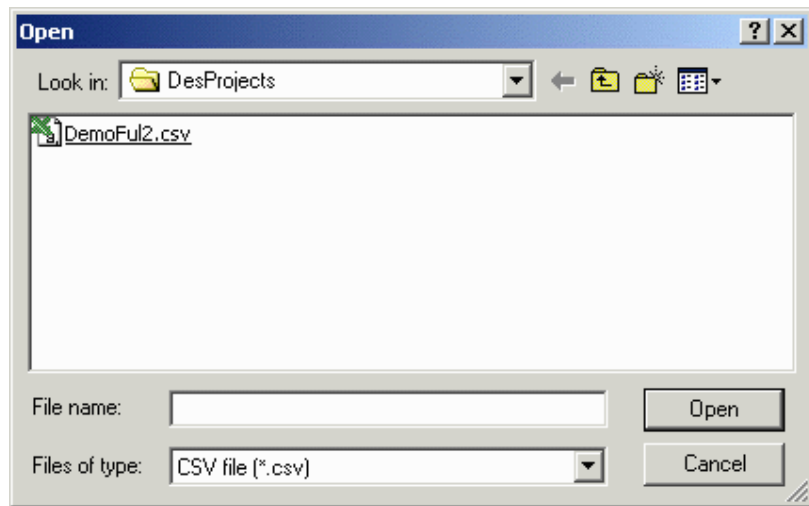

Note: the Import Strings operation may upload a set of strings into the project that are either incompatible or have problems. Before attempting this operation it is recommended to save/backup the strings currently in use by calling the Export Strings function.

### 4.1.13 Recent Files

The most recently opened files are listed under the File menu as a shortcut. Click on the name of a file to reopen it.

### 4.1.14 Exit

Selecting Exit from the File menu can be used to terminate the Designer program. You are prompted to confirm the operation if the current application has not been saved.

## 4.2 Edit Menu

### 4.2.1 Edit Menu

This section provides information about the Edit menu. The Edit menu contains many familiar Windows™ commands for working with text and objects on the page.

Cut

Copy

Paste

Align

Make Same Size

Select All

Fonts

### 4.2.2 Undo

The Undo command reverses the last action. This action can also be activated by pressing the Ctrl+Z keys.

### 4.2.3 Redo

The Redo command reapplies the actions that were previously canceled by the Undo command. This action can also be activated by pressing the Ctrl+Y keys.

### 4.2.4 Cut

The Cut command removes the selected item from the current page and places it on the Windows™ clipboard. This action can also be activated by pressing the Ctrl+X keys.

#### 4.2.5 Copy

The Copy command makes a copy of the selected item from the current page and places it on the Windows™ clipboard. This action can also be activated by pressing the Ctrl+C keys.

#### 4.2.6 Paste

The Paste command places items from the Windows™ clipboard onto the current page at the current position of the cursor. This action can also be activated by pressing the Ctrl+V keys.

#### 4.2.7 Select All

The Select All command selects all of the various items on a page. This makes it easy to cut, copy, or paste a group of objects.

#### 4.2.8 Align

#### 4.2.9 Align

Use the Align commands on the Edit menu to arrange objects/items on a page.

Select an object or item by single-clicking on it, then hold down the Shift key while clicking on other objects or items to be aligned with it. When all of the objects or items to be aligned are selected, choose one of the commands in the Align submenu.

Left

Horiz Center

Right

Top

Vert Center

Bottom

Note: Objects/items are aligned with the last created or inserted object/item.

#### 4.2.10 Left

Aligns the left sides of the objects/items with the left edge of whichever object/item was selected first.

#### **4.2.11 Horiz Center**

Aligns the horizontal center points of the objects/items with the horizontal center point of whichever object/item was selected first.

#### **4.2.12 Align Right**

Aligns the right sides of the objects/items with the right edge of whichever object/item was selected first.

#### **4.2.13 Align Top**

Aligns the top edges of the objects/items with the top edge of whichever object/item was selected first.

#### **4.2.14 Align Vert Center**

Aligns the vertical center points of the objects/items with the vertical center point of whichever object/item was selected first.

#### **4.2.15 Align Bottom**

Aligns the bottom edges of the objects/items with the bottom edge of whichever object/item was selected first.

#### **4.2.16 Make Same Size**

#### **4.2.17 Make Same Size**

Use the Make Same Size commands from the Edit menu to match the size of objects/items on a page.

Select an object or item by single-clicking on it, then hold down the Shift key while clicking on other objects or items to be resized. When all of the objects or items to be resized are selected, choose one of the commands in the Make Same Size submenu.

Width

Height

Both

Note: Objects/items are resized to match the size of the last created or inserted object/item.



#### 4.2.18 Make Same Size Width

Resizes objects/items so that the width matches the width of whichever object/item was selected first.

#### 4.2.19 Make Same Size Height

Resizes objects/items so that the height matches the height of whichever object/item was selected first.

#### 4.2.20 Make Same Size Both

Resizes objects/items so that both the width and height matches the width and height of whichever object/item was selected first.

#### 4.2.21 Fonts

#### 4.2.22 Fonts

Designer makes it easy to select a font that will appear to advantage in a particular project.

There are two types of fonts in Designer: Panel Fonts and Objects Fonts.

Panel fonts are character based type of fonts and are supported by all type of panels.

Object Fonts are based on bit maps and are supported only by graphics panels.

#### 4.2.23 Panel Font

#### 4.2.24 Panel Fonts

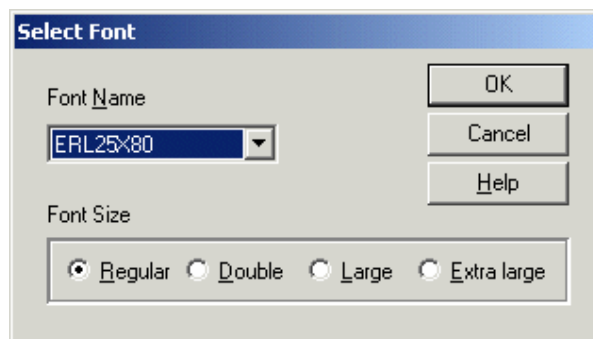

It is possible to have up to four (4) different panel fonts on certain UniOP panels. The Select Font dialog box lets you select a font for onscreen text from a pull-down list.

Note: If a project file contains panel font components, switching to a standard font (not an enhanced font) will erase all of the panel font components in the project.

Font Name

Font Size

#### **4.2.25 Font Name**

Select a panel font for the on-screen text from the pull-down list.

Font Editor

Installing New Panel Fonts

#### **4.2.26 Font Size**

The Font Size buttons can be used to change the character size of any text or variable field.

Font size choices include Regular, Regular, Large or Extra Large. Regular characters are simply a single character.

Double characters are twice the size of a regular character (2x2). Large characters are four times the size of a regular character (4x4).

Extra large characters are eight times the size of a regular character (8x8).

Note: When the area defined for a text box is too small, only the sizes that can fit inside the selected area are enabled.

### 4.2.27 Objects Font

### 4.2.28 Objects Font

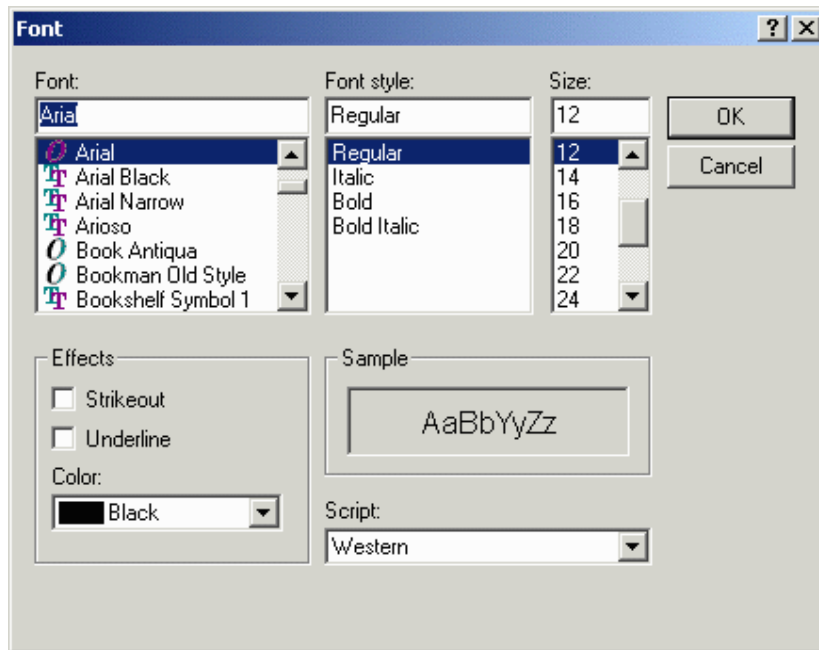

The Font dialog box lets you select the default font for all graphic objects (meters, trends) and the touch cells.

Font

Font Style

Size

Effects

Sample

Script

### 4.2.29 Objects Font Font

Choose a font from the pull-down list. New fonts may be added just like any other True-Type font; by opening Fonts from the Windows™ Control Panel and using the Install New Font command from the File menu. (This is the Windows™ Control Panel File menu, not the Designer File menu.)

### 4.2.30 Objects Font Style

Text may be bold, italic, or both.

### **4.2.31 Objects Font Size**

Select a font size, in points.

### **4.2.32 Objects Font Effects**

Text may be displayed as strikeout or underlined. It is also possible to display text in various colors.

### **4.2.33 Objects Font Sample**

The sample window gives a preview of the selected text settings.

### **4.2.34 Objects Font Script**

Western and various other scripts (Hebrew, Greek, Cyrillic, etc.) are available.

## **4.3 View Menu**

### **4.3.1 View Menu**

This section provides information about the View menu. The View menu lets you set the screen to view the project in the most comfortable manner for various tasks. Commands on the View menu include:

Zoom In

Zoom Out

Status Bar

Toolbars

Workspace

Full Screen

Graphics Library Manager

Layers

### **4.3.2 Zoom In**

Zoom In enlarges items on the screen, although the whole project page may no longer be visible.

This is useful for checking fine details. You can also access this feature by pressing the Ctrl key with the + key of the numeric keypad.

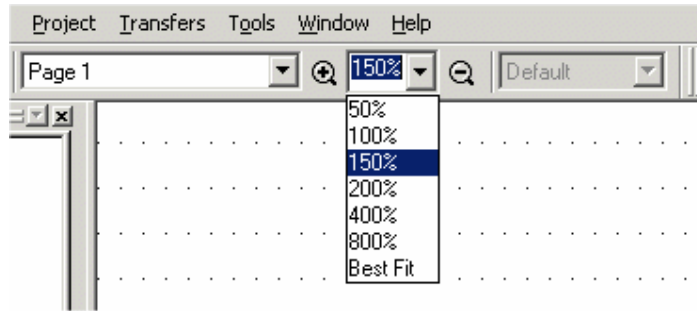

Users can define the view size as a % of the panel size as shown in the above figure. They can pick the percentage from the combo box or pick the best fit or specify any % (within valid range). Zoom size will be changed to best fit once the Panel setup is changed.

### 4.3.3 Zoom Out

Zoom Out makes more of the screen area visible, although items on the screen will appear smaller. This is useful for getting an overall view of the page. You can also access this feature by pressing the Ctrl key with the - key of the numeric keypad.

### 4.3.4 Status Bar

The status bar across the bottom of the Designer screen provides interactive information on various screen items.

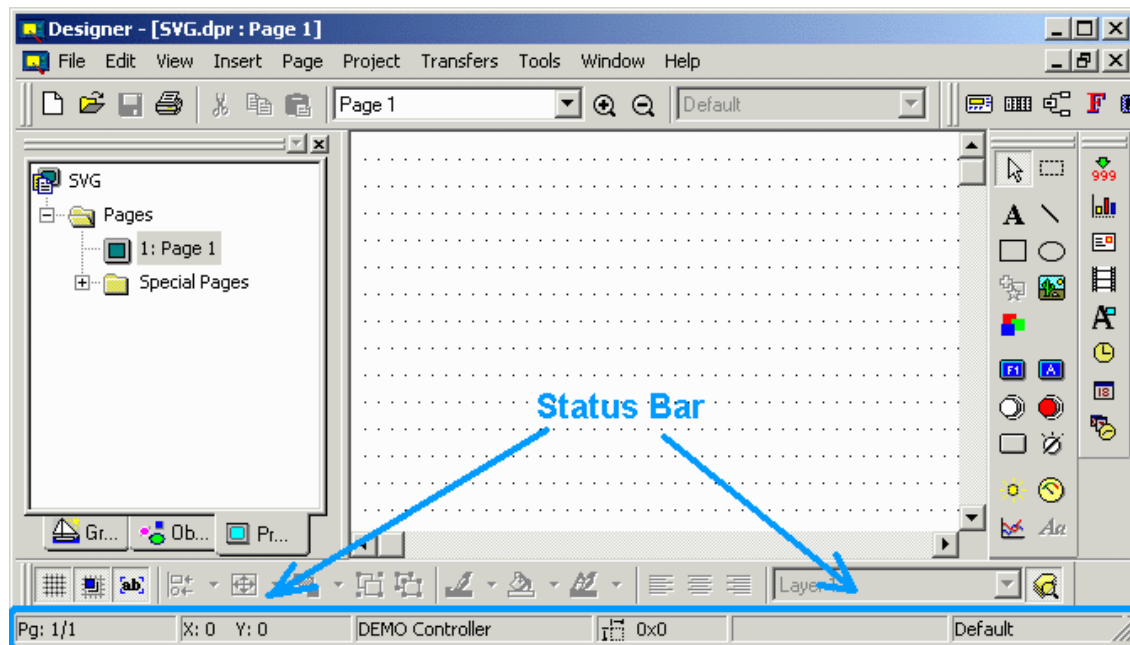

If Status Bar is checked in the View menu, the status bar will be visible across the bottom of the screen. To hide the status bar, uncheck it under the View menu. To make it visible again, simply check it again.

### 4.3.5 Toolbars

### 4.3.6 Toolbars

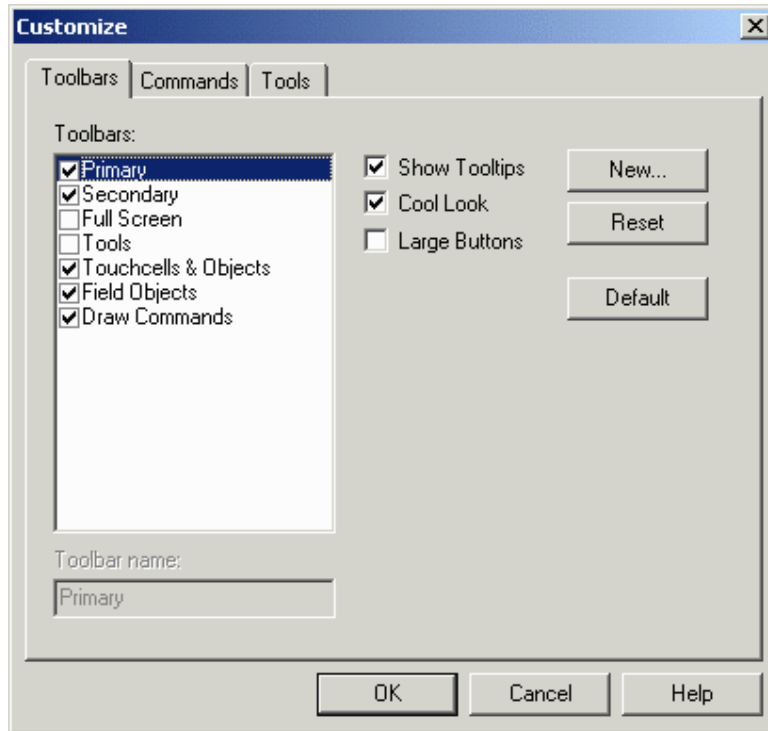

The Toolbars dialog lists the various toolbars displayed for the current project. These may include the following:

Primary toolbar - typically provides shortcuts to commonly used Windows™-type commands.

Secondary toolbar - typically provides shortcuts to Designer project-level commands

Full Screen toolbar - typically provides shortcuts to viewing preferences

Tools toolbar - typically provides shortcuts to user-specified tools

TouchScreen toolbar - typically provides shortcuts to touchscreen-specific commands

Commands available from the Toolbars dialog box include:

Toolbar Name

Shows the name of the selected toolbar.

### Show Tooltips

Provides a short description of a toolbar icon when the cursor pauses above the icon.

### Cool Look

Gives the buttons on the toolbars an invisible edge, making for a smoother appearance on the toolbars.

### Large Buttons

Makes the buttons appear twice as large as normal for easier viewing and use.

### New

#### Reset/Delete

The Reset button returns the toolbars to their default state.

If you have added any toolbars, the Reset button becomes a Delete button so that user-added toolbars can be removed.

#### Default

Click the Default button to align and dock the toolbars to the installed state. It also reloads all buttons on the toolbar.

### 4.3.7 New

The New button brings up the New Toolbar dialog box, where you may enter the name of a new toolbar to be created.

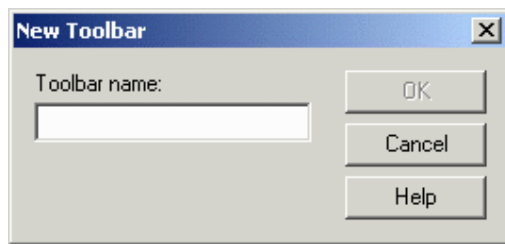

The new toolbar may then be placed in a location of your choice in the toolbar section of the Designer screen.

## 4.3.8 Workspace

The status bar to the left of the main Designer screen provides information on project pages and lists various graphics and objects that can be placed in a project. If Workspace is checked in the View menu, the workspace will be visible.

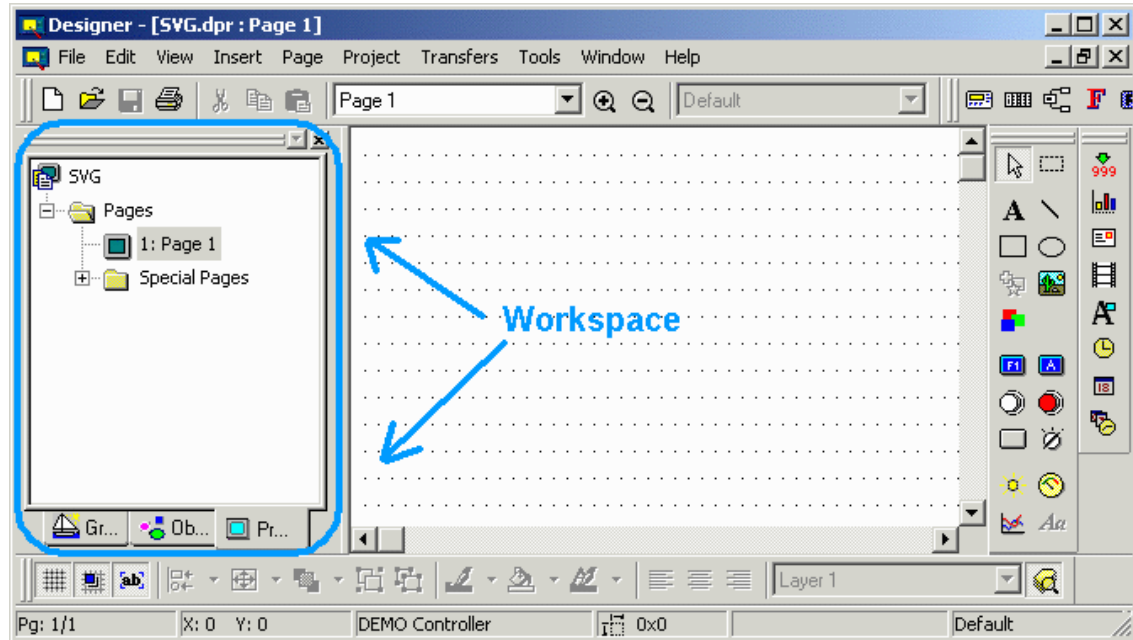

The default position of the workspace is to the left of the main Designer screen, however the workspace can be moved anywhere on the Designer screen. To hide the workspace, uncheck it under the View menu. To make it visible again, simply check it again.

Note: Right-clicking in the frame of the workspace box brings up a number of options for viewing the workspace. Select Allow Docking to dock the workspace against any of the four sides of the application. If the check box is removed, then the workspace will act as a mini-window, which can be placed anywhere and resized. On the other hand, clicking Float in main window causes the workspace to occupy the entire application window and minimize the graphics view.

## 4.3.9 Full Screen

The Full Screen command in the View menu (and the Full Screen icon) enlarges the Designer screen to occupy the full screen size.

A small toolbar remains on the screen with Full Screen, Zoom In, and Zoom Out icons to let you easily select other viewing options.

Clicking on the Full Screen icon again takes Designer out of Full Screen view.



## 4.3.10 Graphics Library

### 4.3.11 Graphics Library Manager

The Graphics Library Manager dialog box provides an easy way to work with graphics libraries.

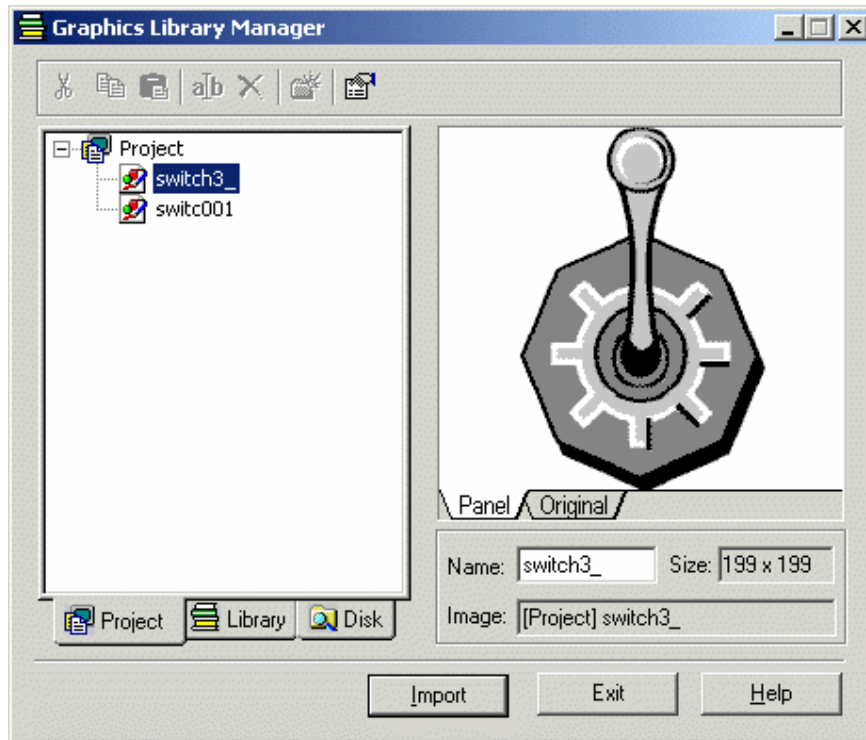

The dialog box has three tabs:

Project - shows the graphics libraries currently used in the project

Library - shows the graphics libraries currently installed and accessible to Designer

Disk - allows to work with file system to load, save graphic files.

### 4.3.12 Project

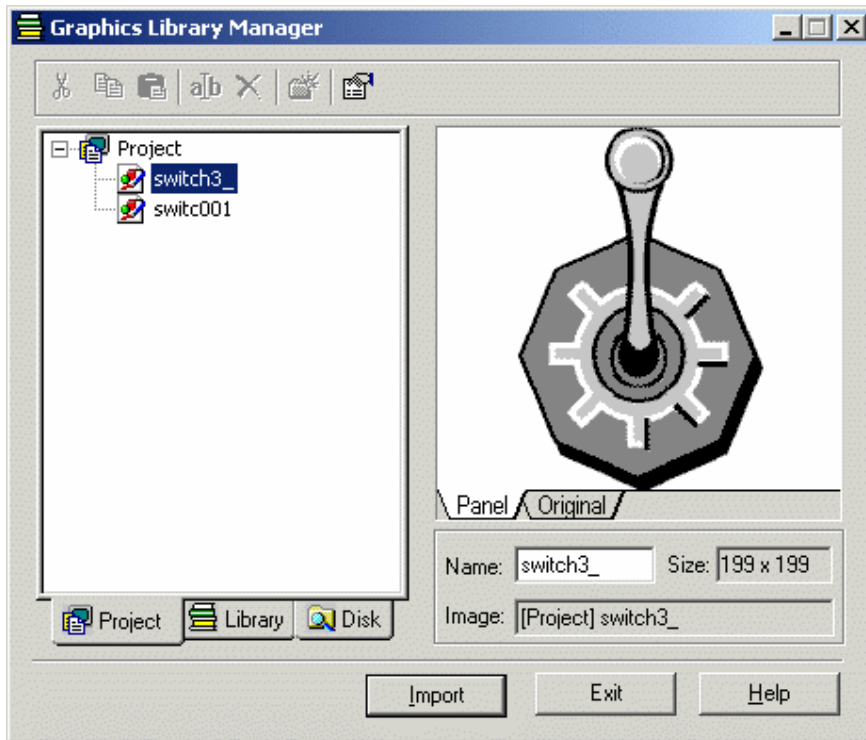

This tab allows the user to see how many graphic symbols are present in the project and, if needed, to change their names.

The button Import puts the currently selected graphic symbol into the Project Screen area.

### 4.3.13 Library

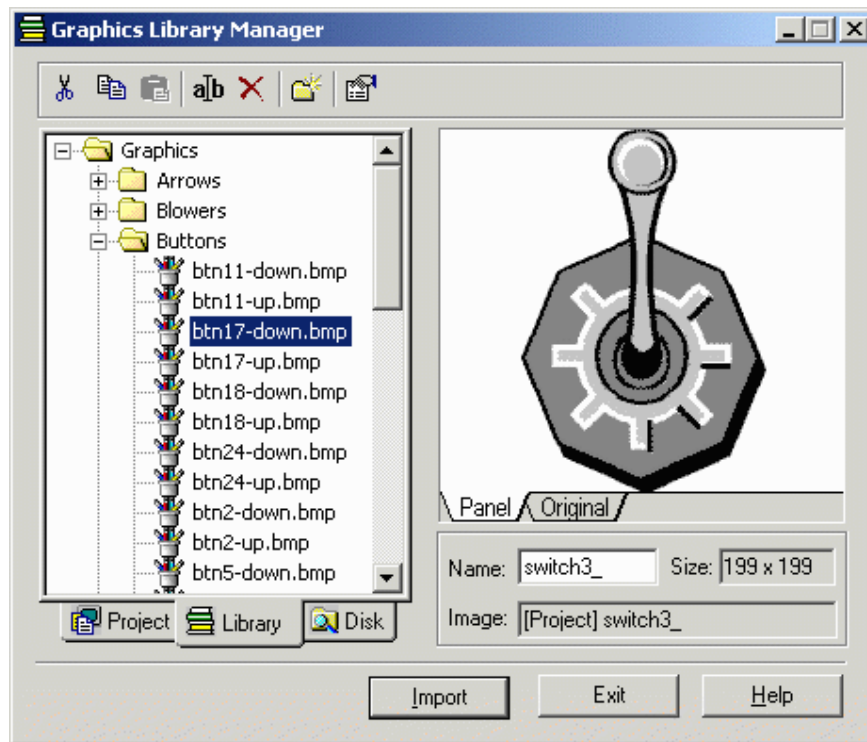

This tab allows to modify/update the contents of the graphics library.

The tab contains a toolbar providing access to the familiar Windows™ commands of cut, copy, paste, rename, delete, and insert folder for graphics management. A Properties icon leading to a dialog box with the properties of the currently selected graphic symbol is also available.

Users, if needed, can change the name of the graphic symbols used in the project.

The button Import puts the currently selected graphic symbol into the Project Screen area.

### 4.3.14 Disk

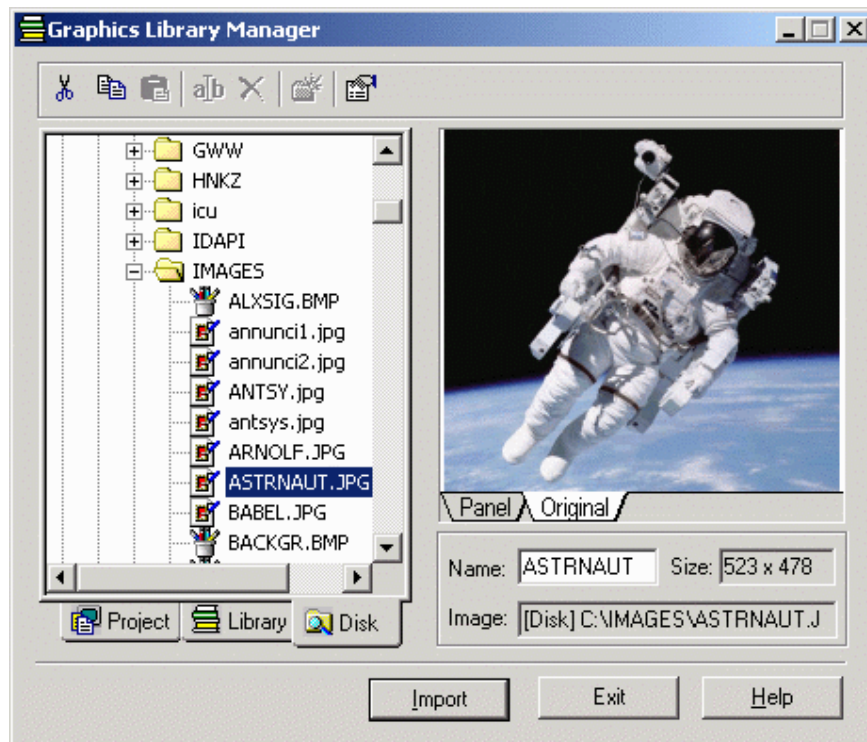

This tab allows to select a new graphic symbol (a new picture) from the file system.

The button Import puts the currently selected graphic symbol into the Project Screen area.

### 4.3.15 Layers

#### 4.3.16 Layers

Each UniOP page is actually divided into layers. Layers define a set of planes, stacked along the Z-axis of the screen, i.e. the axis that goes from the screen to the eye of the user/observer. Thanks to layers it is possible to control in an easy way the Z-ordering (that is the position along the Z-axis) of a group of objects and graphics. For instance, by changing the position of a layer relative to the others, also the position of all the objects and lines belonging to that layer are modified.

Objects and graphics are inserted into the currently active layer. The active layer can be selected by using the layers toolbar (usually positioned at the bottom of the work area).



The layers dialog controls how layers are displayed, allows to create new layers, delete them and change their reciprocal order.

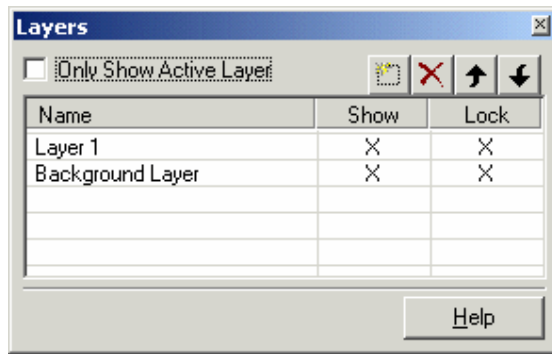

These are the available commands:

Insert

Delete

Move Item Up

Move Item Down

Show and Lock Active Layers

Only Show Active Layers

Note: Layers are a Designer feature introduced to easily configure the Z-ordering of objects and graphics on the panel screen. The UniOP panel only supports the relative Z-ordering of objects and graphics (no layers).

### 4.3.17 Insert

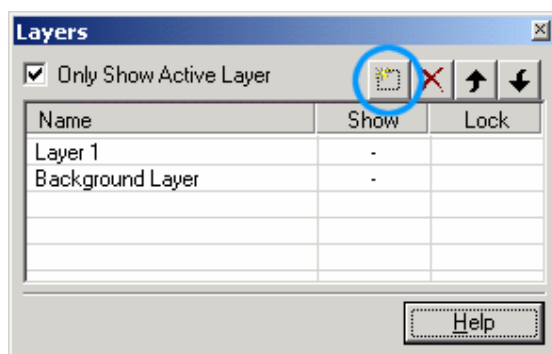

Inserts a new layer.

### 4.3.18 Delete

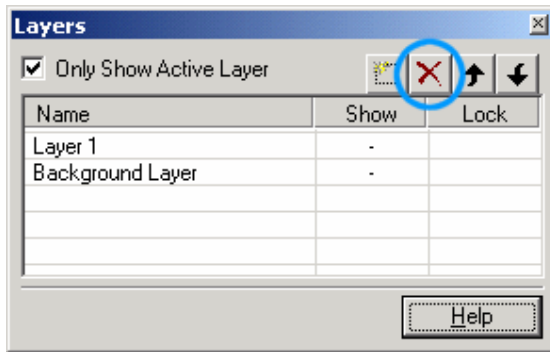

Deletes the selected layer.

### 4.3.19 Move Item Up

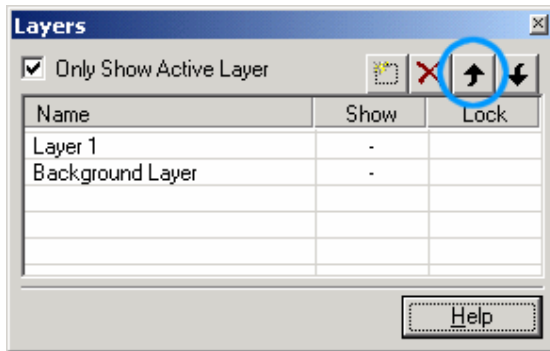

Moves the layer occupied by an item forward.

### 4.3.20 Move Item Down

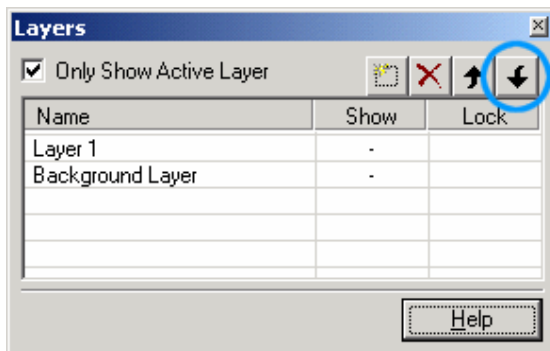

Moves the layer occupied by an item downward.

## 4.3.21 Show and Lock Active Layers

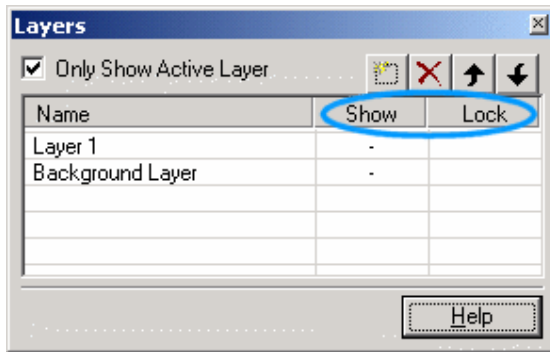

The Show option controls if a given layer can be displayed or not.

The (Un)Lock option controls if a layer can be moved.

## 4.3.22 Only Show Active Layers

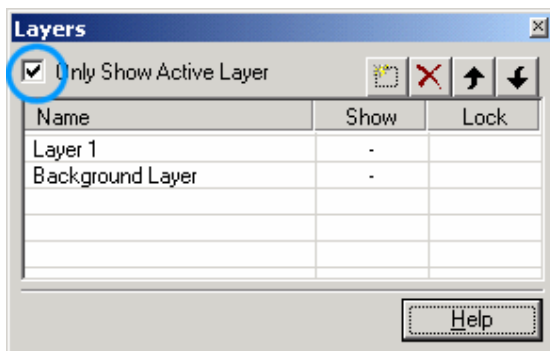

This option makes Designer show only the active layers.

## 4.4 Insert Menu

### 4.4.1 Insert Menu

This section provides information about the Insert menu. The Insert menu gives you the means to easily place text and/or objects onto a project page. Some of these objects, such as numeric fields or bar graphs display information from the controller. Other objects, such as the various types of touch cells, allow a panel user to interact with the panel.

Text

Bitmap

Data Fields

Touch Cells

Shapes

Trend Window

Meter Instrument

Trend Time Field

Recipe Menu

Special Characters

Import Bitmap Graphics

#### **4.4.2 Text**

To insert a Text Field, either click on the Text icon in the toolbar or select Text from the Insert menu. Use the cursor to specify the location of the text box. Once a text box is created, click to place the cursor inside the text box and type the text that is to be inserted.

Note: The text uses the font selected in the Select Font dialog box. This dialog box can be accessed by clicking on the Font icon in the toolbar or by selecting Edit - Fonts - Panel Font. The font must be specified before the text is created. If the font is too large for the selected area, Designer will not allow the text to be entered.

To edit a text field, select the field by left-clicking on it, then right-click on the text field to bring up an edit menu for the text field. Text can be cut, copied, or pasted, edited, foreground and background colors can be set, or text can be resized.

#### **4.4.3 Bitmap**

To insert a custom bitmap image, either click on the Bitmap icon in the toolbar or select Bitmap from the Insert menu. Use the cursor to specify the location of the bitmap image. The Bitmap Editor dialog box then appears.



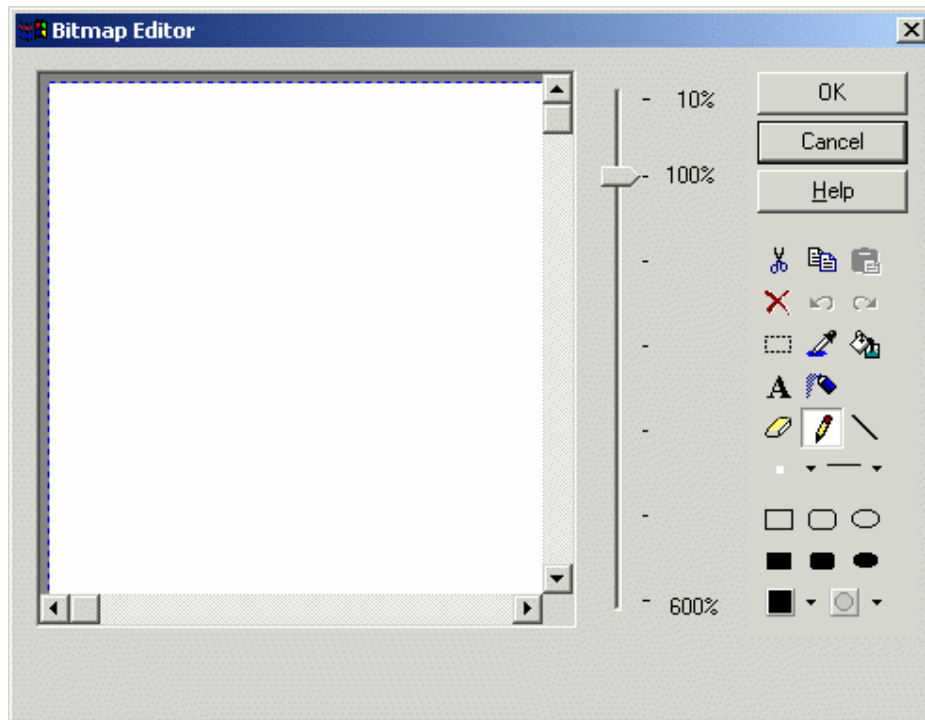

A sliding bar lets you zoom in or out for easier editing. Familiar Windows™ drawing tools are available to create a custom bitmap image.

On invoking the Foreground color and Transparency color button of Bitmap editor dialog will popup a palette with 16 colors and a "More Colors ..." button as shown in the below figures.



On invoking the More Colors button a 256 color palette (If 256 colors are supported) dialog is shown. From the this the user can select the required palette. When the mouse is over a particular color box RGB values of the same is shown as tooltip as shown in the following figure.

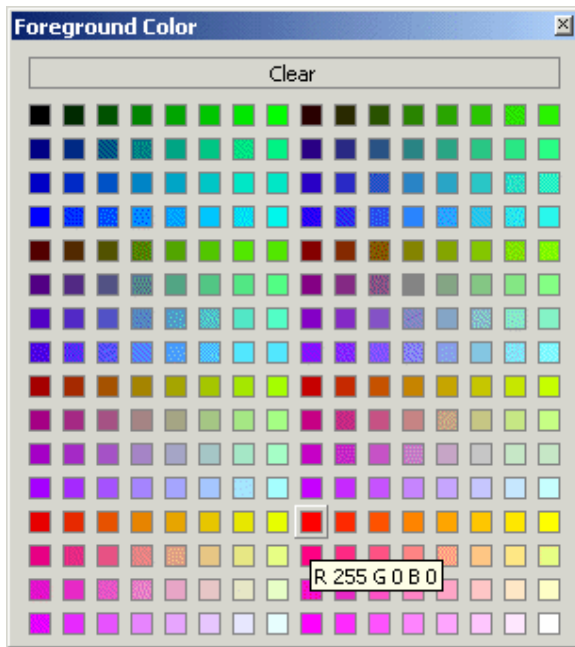

#### 4.4.4 Data Fields

#### 4.4.5 Data Fields

Data fields are those items that the Designer software uses to display information from the controller.

These dynamic data items come in the form of numeric fields (which can be displayed in numeric format or in ASCII format), bargraphs, message fields, attributes, dynamic graphics, time, and date fields.

These fields can be created by either selecting one of the seven types of fields from the Data Fields submenu in the Insert menu or by clicking on the various data field icons in the toolbar. This brings up the data Field Properties dialog box for the appropriate data field type.

#### 4.4.6 Numeric/ASCII

#### 4.4.7 Numeric/ASCII Data Fields

This option is used to add a numeric data field or an ASCII data field to the current page. A numeric data field reflects a numeric value read from the controller. An ASCII data field displays a character string read from the controller. (An ASCII data field differs from a plain text field in that an ASCII data field interacts with the controller whereas plain text is a static screen item.)

A numeric/ASCII data field can be created by either clicking on the Numeric Field icon in the toolbar or by selecting Insert - Data Fields - Numeric/ASCII. Use the cursor to specify the location of the item. Once the numeric/ASCII field is created, the Numeric Field Properties dialog box will appear.

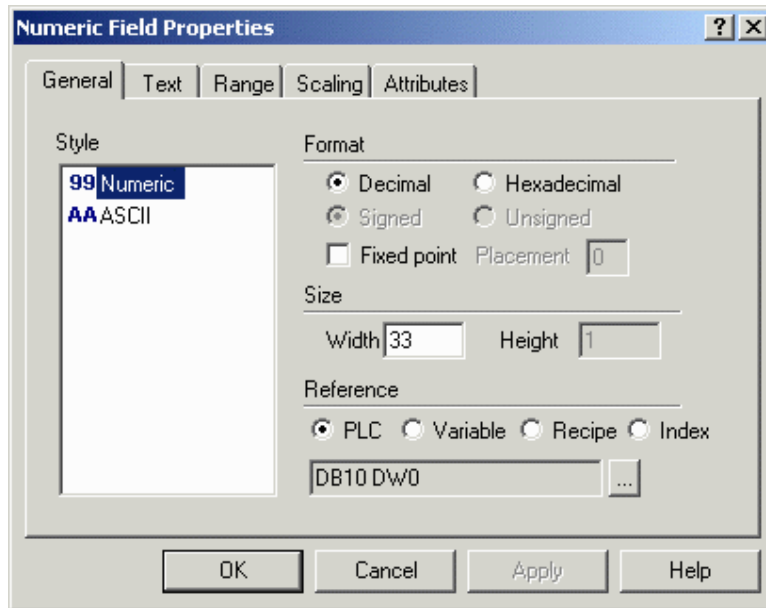

A number of items can be configured from this dialog box. They are grouped in the following tabs:

General

Text

Range

Scaling

Attributes

An external small window allows to Preview the data files. A placeholder of 9's is used to indicate the presence of a numeric data field in Designer, while a placeholder of A's indicates an ASCII data field.

#### 4.4.8 Preview

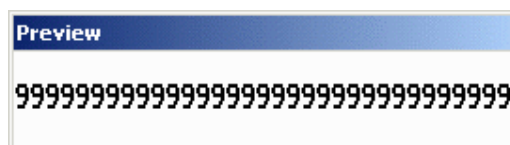

If a numeric format is chosen, the field will be represented by 9's the panel. If an ASCII format is chosen, the field will be shown as A's on the display. If Reference is set to Variable,

the field is shown as C's on the display. If Reference is set to Recipe, the field is shown as R's on the display.

#### 4.4.9 General

#### 4.4.10 General tab

The Style, Format, and Size portions of this dialog box are not controller specific. These areas are used to instruct the panel in the manner in which to display the data.

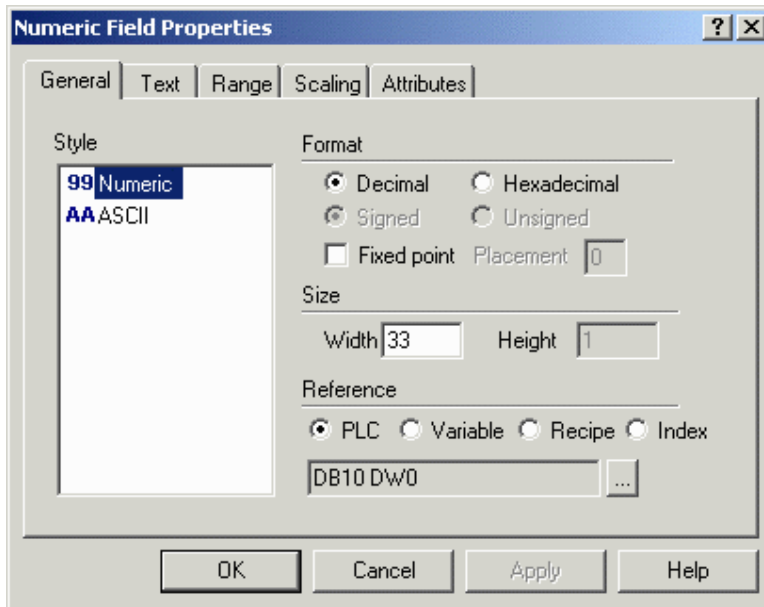

The Reference area is controller specific.

#### 4.4.11 Style

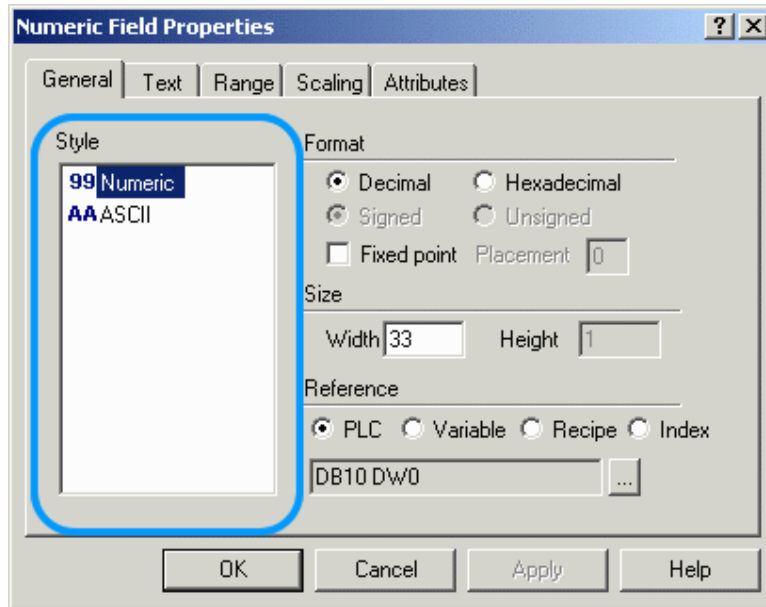

You can choose a numeric data field that displays numbers or an ASCII data field that displays ASCII characters.

#### 4.4.12 Format

##### Format

The Format area allows you to format the data field. These choices will vary according to the capabilities of your controller.

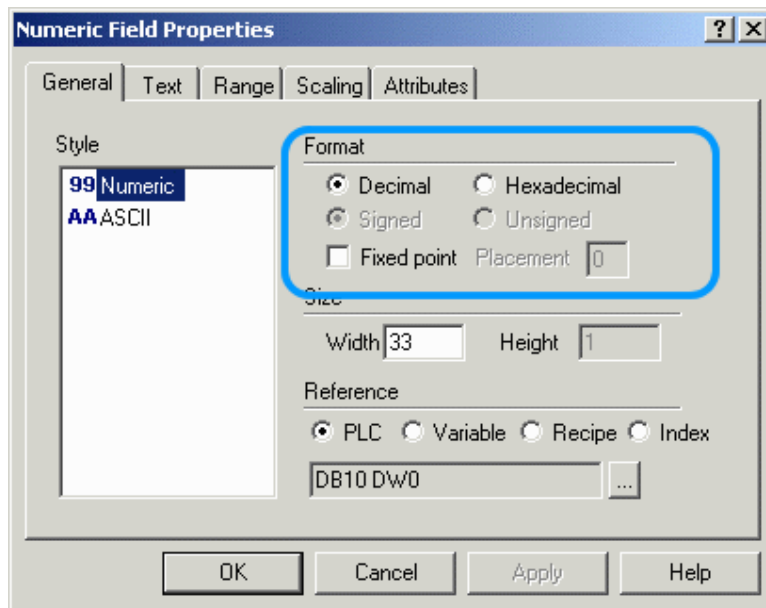

Format choices for Numeric/ASCII data fields include

Decimal/Hexadecimal

Signed/Unsigned

Fixed Point Placement.

### Decimal Hexadecimal Base

You can choose between a decimal base (base 10) or a hexadecimal base (base 16).

Note: When the Reference is set to Recipe, the initial values entered for a particular Recipe data field will be in the format specified for that data item. For example, if a numeric format of Hexadecimal is entered for a Recipe data field, then all the values entered in the Recipe Configuration dialog box for this Recipe data field will be in hexadecimal. A value of 10 entered in a Recipe Configuration dialog box under these circumstances will be interpreted as 10 hexadecimal.

### Signed / Unsigned

Options are Signed or Unsigned data format. Supposing the variable's data area has a length of N bits, if the Unsigned option is chosen the variable is interpreted as an integer ranging from 0 to  $2^N - 1$ . If the Signed option is chosen the variable is interpreted as a two complement integers ranging from  $-2^{N-1}$  to  $2^{N-1} - 1$ . These choices are only active when the specified controller supports signed/unsigned data format.

### Fixed Point Placement

The fixed point option permits you to select how many decimal points, if any, are displayed on the panel. This feature parallels with scaling. Enter the number of decimal places to be displayed in the Placement box.

Note: Keep in mind that the decimal point will take up one position in the field (i.e., a field with a width of four and a placement of 1 can display at most the number 99.9).

## 4.4.13 Size

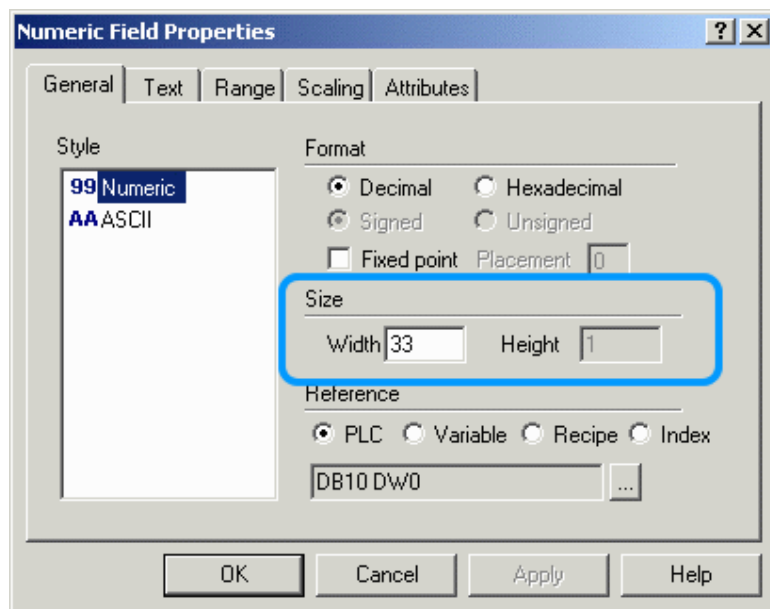

This is the width and height of the field. Each number or letter is one unit wide. Numbers are one unit high as well.

Note: The field width/height cannot exceed the width/height of remaining panel from the current cursor row/column position.

Note: Size is adjusted depending on the current font size. Double font takes twice the width/height of regular font size, etc.

## 4.4.14 Reference

### Reference

The Reference area is the memory location in the controller to be used, and is dependent upon the type of controller selected. The field data type, data format, and address reference are all configured in this area. Only the items pertaining to the controller type and file type will be configurable.

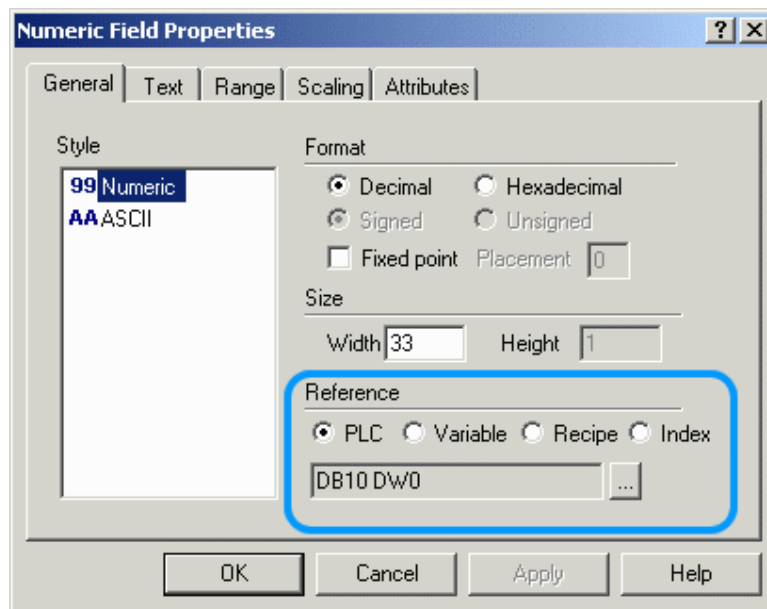

Reference choices for numeric data fields include PLC, Variable, Recipe, and Index. Index references are not available for ASCII data fields.

### Data Field Properties

This feature can be accessed by selecting the "." button whenever a PLC, Variable, or Recipe reference is set. (If Index is selected, a similar box named Indirect Addressing Fields appears.)

The contents of the Data Field Properties dialog box will vary depending upon the type of controller being used and the type of reference specified. Elements to be configured may include the File or Data Type, the Data Format, File or Page Number, Element, Offset, and Left/Right Byte. These options let you configure responses to the controller memory location.

### PLC

The internal PLC (programmable logic controller) installed on a UniOP panel is conceptually speaking a special UniNet node. The appearance of the PLC Data Field Properties dialog box depends on the internal controller setup but will always be according to the UniNet configuration style.

To configure the PLC data field properties, either click on the appropriate icon in the toolbar or select Numeric/ACSII, Bargraph, Message, Attribute, or Dynamic Graphics from Insert - Data Fields, then use the cursor to specify the location of the item. In the Properties dialog box click the PLC radio button under Reference and then click on the "..." button.

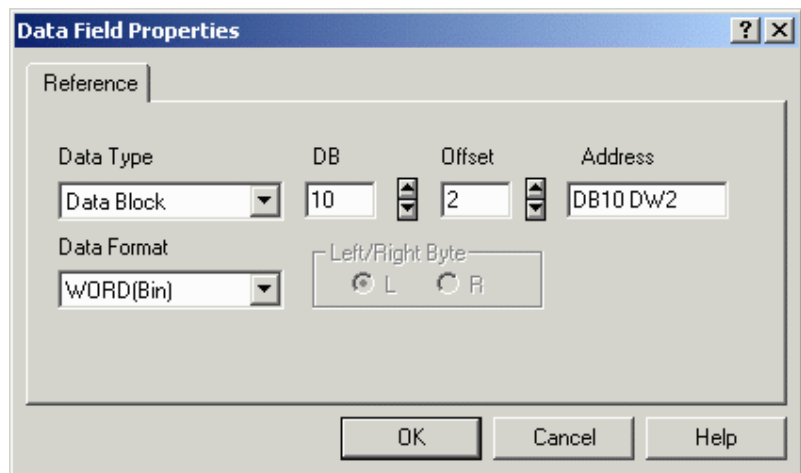

See Data Field Properties for more information regarding the configuration of data field properties.

Variable

**Variable**

Control variables are special data items stored in the UniOP panel memory that offer a means of controlling and monitoring recipes. You can control certain operations of the panel by modifying the values held in these internal variables. Elements to be configured include the data type, the data format, page number, and address. These options allow you to configure responses to the controller memory location.

To configure Variable data field properties, select Numeric/ACSII, Bargraph or Message under Insert - Data Fields, then use the cursor to specify the location of the item. The Properties dialog box appears. Click the Variable button under Reference and then click on the "..." button to configure the data field properties for control variables.

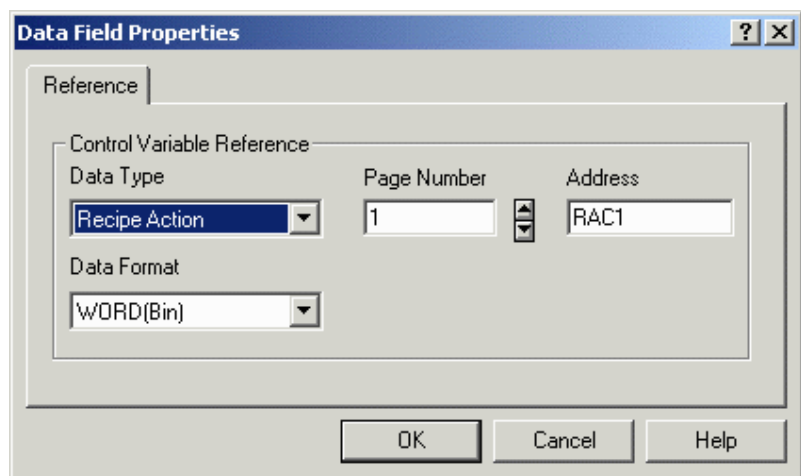



Note: To change properties of an existing variable data field, right-click on the data field and select Properties.

There are various types of control variables:

Recipe File Status

Recipe Parameter Set Selection

Recipe Action

Data Entry Status

Data Entry Field Number

Language

Password

Recipe Key

Recipe Page for Selection

Passthrough Status

Internal Variable

Recipe/Event Backup

PLC Port Mode

PC/Printer Port Mode

PLC Port Module Number

PC/Printer Port Module Number

**Recipe File Status**

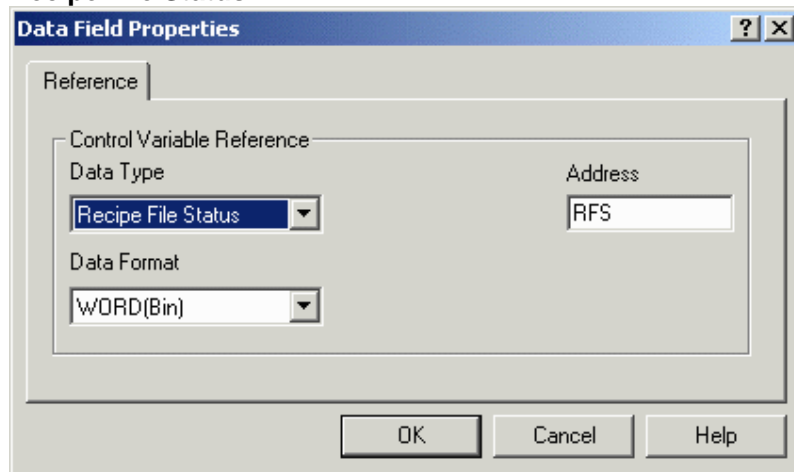

In the UniOP panel memory there is a single memory location that is used to store the status of the entire recipe data in the panel. This memory location is called the Recipe File Status.

The Recipe File Status cannot be modified by the panel's user; it is controlled by the internal logic in the panel.

The Recipe File Status can take on only 2 values, 0 or 1. A value of 0 indicates that all of the recipe data for every page in the project is valid. A value of 1 indicates that an error in some part of the recipe data was found. This means that the integrity of the recipe data is compromised. It is very rare for this to happen, but it can feasibly occur if the UniOP panel is powered off while the user is modifying the value of a recipe data field.

If the Recipe File Status has a value of 1, the panel's user must physically change the value of one of the recipe data items to reset the Recipe File Status to 0. Until this occurs, the user will not be able to perform recipe transfers.

### Recipe Parameter Set Selection

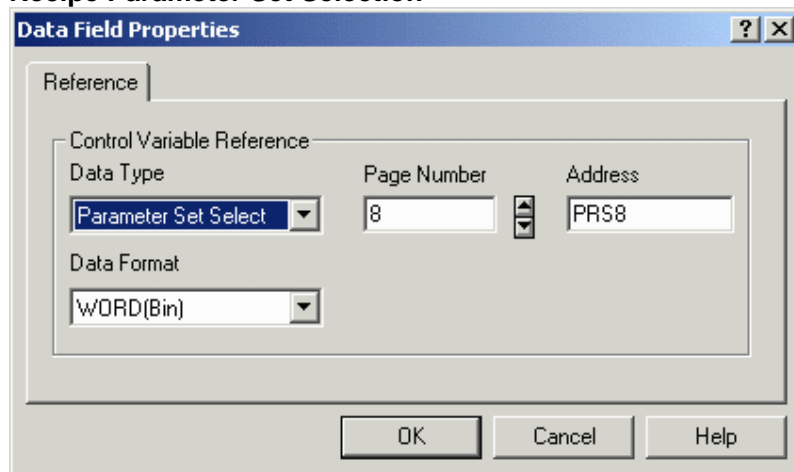

The UniOP panel reserves a separate memory location for the Recipe Parameter Set Selection for each recipe page. The Recipe Parameter Set Selection memory location stores the numeric identifier of the currently selected recipe parameter set for the recipe page.

Recipe Parameter Set Selection data fields can be used to visually display the currently selected recipe parameter sets of the various recipes in the project. When these data fields are added to a project, they must specify which recipe is to be monitored by the data fields. This is done by specifying the page number that contains the required recipe in the Data Field Properties dialog box.

For example, a project might contain three recipes, one on page 2, one on page 3 and the other on page 7. To monitor the currently selected recipe parameter sets of these three different recipes, three Recipe Parameter Set Selection data fields must be added to the project. One of these data fields will be used to monitor the recipe on page 2, one to monitor the recipe on page 3 and the third to monitor the recipe on page 7. These three Recipe Parameter Set Selection data fields could all be placed on any page of the project. Regardless of where they are placed in the project, the address of the first data field would be Recipe Parameter Set Selection 2, the address of the second data field would be Recipe Parameter Set Selection 3 and the address of the third data field would be Recipe Parameter Set Selection 7.

You can also change the parameter set of a recipe on a particular page by modifying the value held in the Recipe Parameter Set Selection variable. This is done in the same way as changing the value of a normal controller data field. For example, to make recipe parameter set number 3 the current parameter set, enter a value of 3 in the appropriate Recipe Parameter Set Selection variable. In order to do this, the Recipe Parameter Set Selection variable must be set as a Read/Write variable on the Range tab of the Properties dialog box under Insert - Data Fields - Numeric/ASCII, Bargraph, or Message.

### Recipe Action

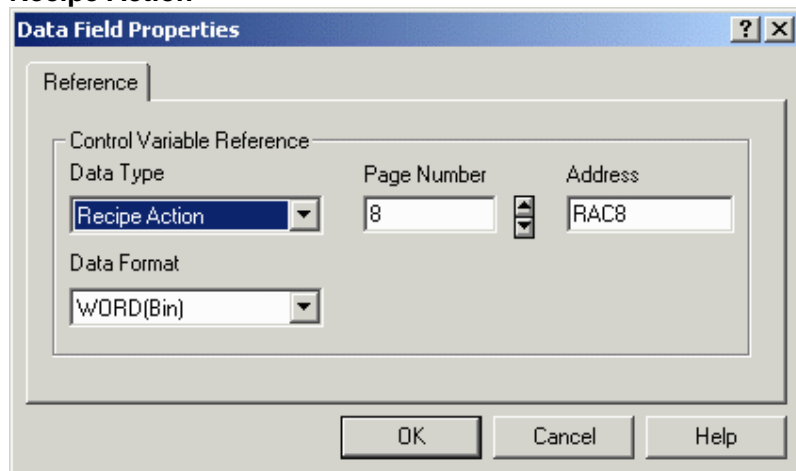

For each page that contains a recipe, the UniOP panel reserves a separate memory location for the Recipe Action for that recipe page. The Recipe Action memory location stores the current status of operation of the recipe for the page.

Recipe Action data fields can be added to the project. These data items can then be used to visually display the current state of the various recipes in the project.

When these data items are added to the project, they must specify which recipe is to be monitored by the data item. This is done by specifying the page number that contains the required recipe in the Data Field Properties dialog box.

A Recipe Action data field can take on only 3 values: 0, 1 or 2.

A value of 0 indicates that the recipe is in its normal state of operation. In this mode of operation, the values of the recipe data fields are displayed on the screen of the panel and the values of the recipe data fields can be modified.

A value of 1 indicates that the recipe data for the currently selected parameter set is being transferred to the controller. When the transfer is complete the value is automatically reset to 0.

A value of 2 indicates that the recipe data for the currently selected parameter set is being transferred to the panel. When the transfer is complete the value is automatically reset to 0.

You can start a recipe transfer by entering a value of 1 or 2 for the Recipe Action data item. By entering a value of 1, you can force the UniOP panel to send the recipe data for the currently selected parameter set to the controller. By entering a value of 2, you can force the controller to transfer the recipe data for the currently selected parameter set to the panel.

### Data Entry Status

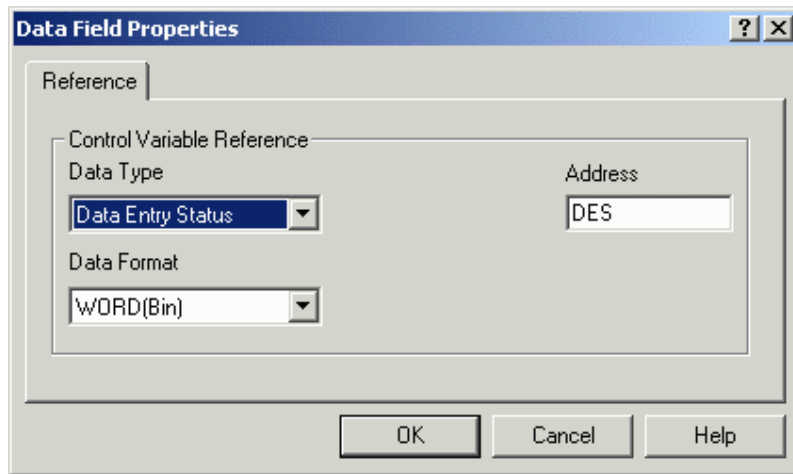

This control variable will be set to a 1 while the UniOP panel is in Data Entry Mode. In all other modes it will be set to 0.

### Data Entry Field Number

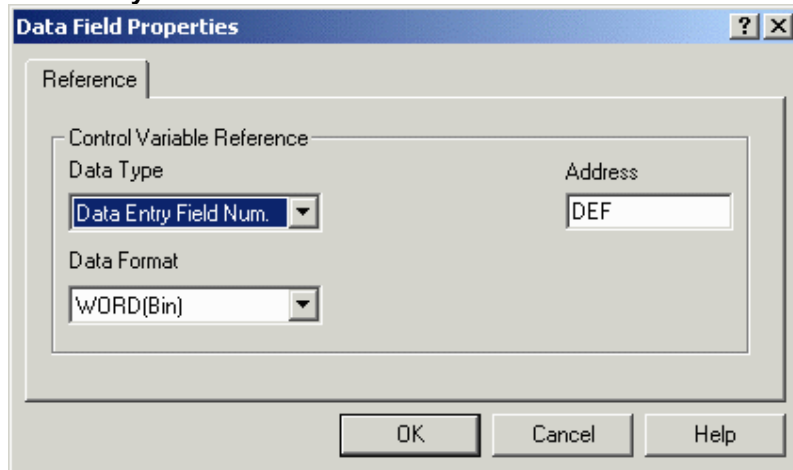

This control variable simply contains the field number of the selected data entry field whenever the panel is in Data Entry Mode.

### Language

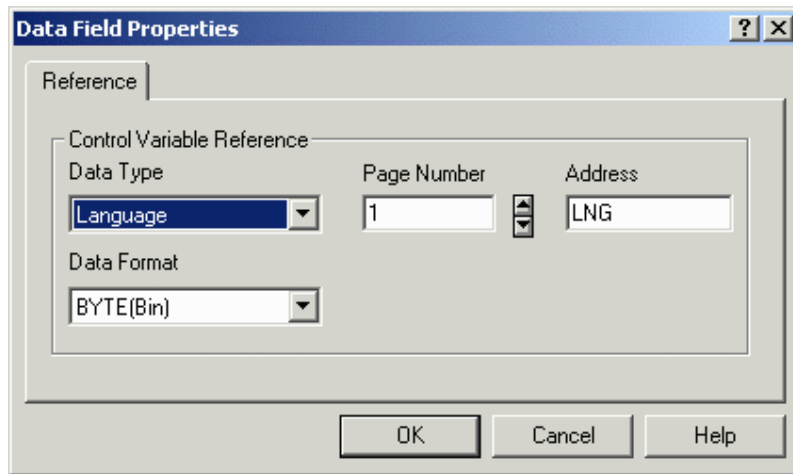

In order to change the language that the project file uses once it has been downloaded to the UniOP panel, you can create a control variable with a data type of Language. Make sure that this field is created as read/write so that it can be edited.

To change the language that is being used, you will need to increment or decrement this field. This can be done in one of two ways. One way is to simply edit the field and enter the number of the language that you want to use. The other way is to program a key or a touchcell using the macro command Step Control Variables. You could program one key (or touchcell) to step up the value of the language control variable field, and another key (or touchcell) to step down the value of the language control variable field.

### Password

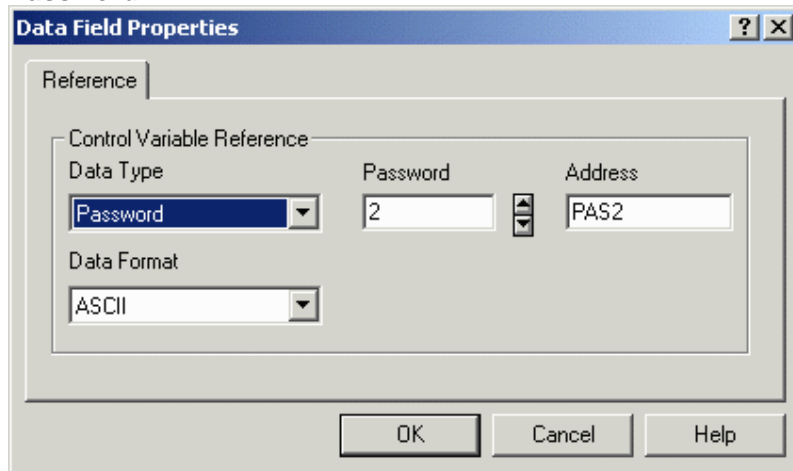

The Password field is an ASCII field, and is only available under Insert - Data Fields - Numeric/ASCII when ASCII is chosen as the Style.

### Recipe Page for Selection

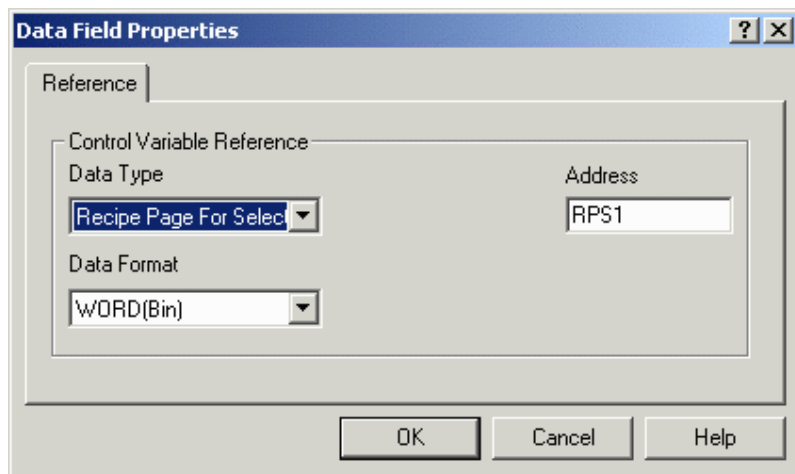

The purpose of the Recipe Page For Selection field is to show the number of the page containing the actual recipe data referred to by the Recipe Menu.

It can be placed on the same page with a Recipe Menu field to show the recipe page number. It can also be edited to change the page for which the Recipe Menu field displays information. If the Recipe Page For Selection contains the page number of a page without a defined Recipe Name field, the Recipe Menu field will display asterisks ("\*\*"). After powering up the UniOP, the Recipe Page For Selection is set to zero.

### Recipe Key

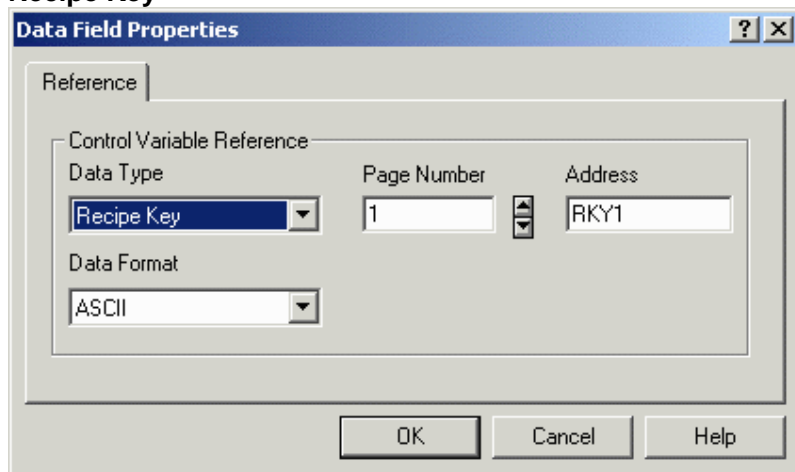

The Recipe Key field is an ASCII field, and is only available under Insert - Data Fields - Numeric/ASCII when ASCII is chosen as the Style. The Recipe Key field displays the currently selected Recipe Parameter Set name for the referred page.

Note: The page to which a Recipe Key field refers in the Data Field Properties dialog box must have a defined Recipe Name field. This is done by adding a Recipe data field with an ASCII display format on the page where the recipe is located and filling the Recipe Item values in the Recipe Configuration box with an ASCII name for each parameter set. This ASCII field is called a Recipe Name field. If the referred page has no Recipe Name field defined, the Recipe Key field will display asterisks ("\*\*").

### Passthrough Status

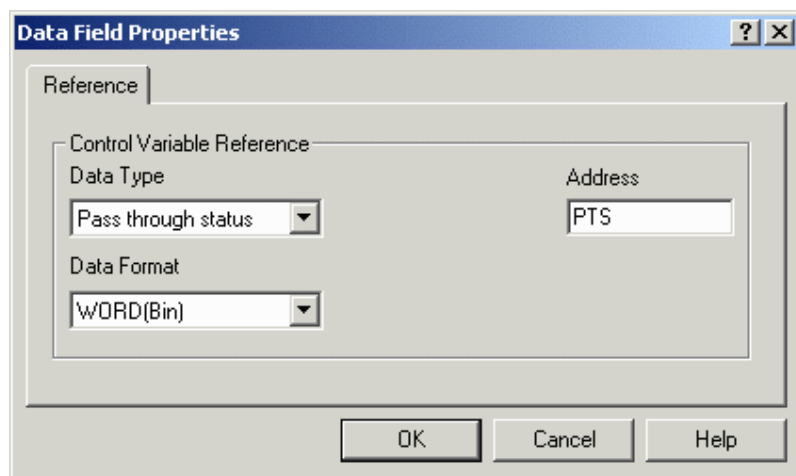

When passthrough mode has been activated, the UniOP panel does not communicate with the controller and the dynamic data displayed on the screen may no longer be correct. It may be useful to inform the user when the passthrough option is active.

A new control variable has been defined for this purpose. The control variable name is Passthrough Status. This variable can take on two values; zero, meaning that passthrough is not active, or one, meaning that passthrough is active.

**Internal Variable**

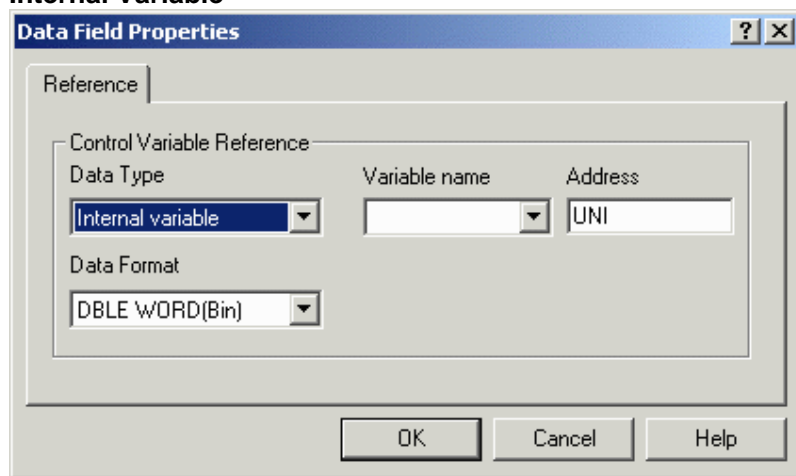

The internal panel control variables associated with trending can be defined and used from the trend viewer. Alphanumeric values of these variables can be displayed on the UniOP.

To access these variables, it is necessary to create a numeric data field with a reference type Variable.

Select the UniOP variable from the Data Field Properties Type list box. This will show the list of variables that have already been defined. The meaning of these variables can be found inside the trend viewer.

**Recipe/Event Backup**

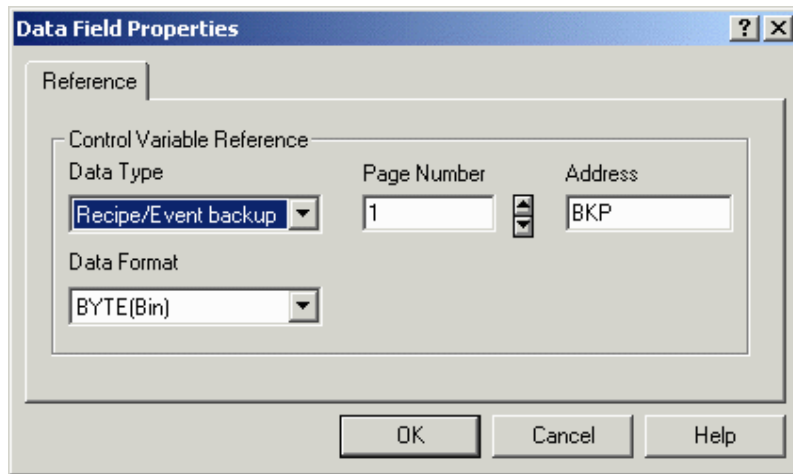

On some UniOP panels, it is possible to back up recipe data and the event list into flash memory inside the UniOP. Even if the UniOP panel loses power AND the backup battery is discharged or missing, the recipe data and the event list will be preserved.

Please note that selecting this feature uses memory within the UniOP panel that is normally reserved for the project file. Therefore, the amount of memory available for the project file is reduced by the amount of memory reserved for the entire backup of both recipe data and the event list, which is 128 KB.

When this feature is enabled, recipes are copied to flash memory automatically from the UniOP after any recipe backup or recipe upload operation. The event list is copied to flash memory any time one event happens. A new macro can be used to perform a manually backup operations.

During the write operation to flash memory the panel LED #65 will flash to indicate that a write operation is in progress. Some UniOP panels do not have this LED. For those UniOP panels that do not have this LED, the control variable Recipe/Event Backup can be used to give feedback to the operator on the status of the backup operation. This control variable can assume the values listed below.

Recipe/Event Backup:

0 = Standby

1 = Backup operation in progress

The S12 bit of the RDA area is used to communicate to the controller when a backup operation to flash memory is in process. The UniOP will set this bit to 1 just before the backup operation begins. When the backup operation is complete, UniOP will set this bit to 0.

## PLC Port Mode



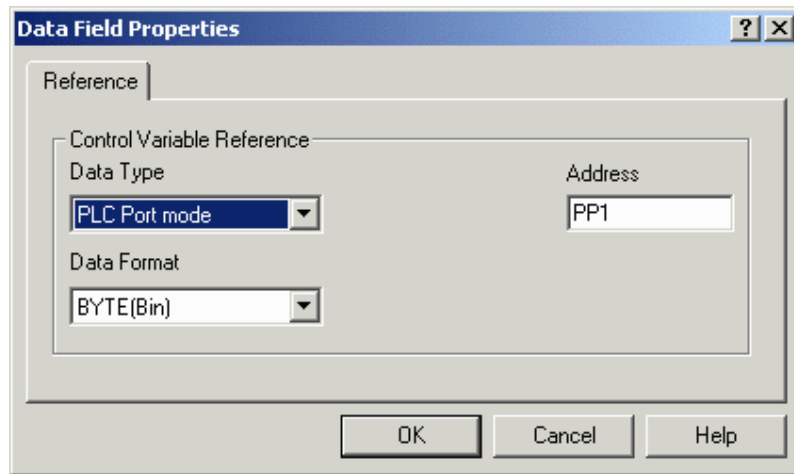

This variable provides information about the status of the PLC Port assignment.

Value	Assignment
0	Assigned to Panel
1	Assigned to Internal Controller - User Mode
2	Assigned to Internal Controller - Service Mode

**PC Printer Port Module Number**

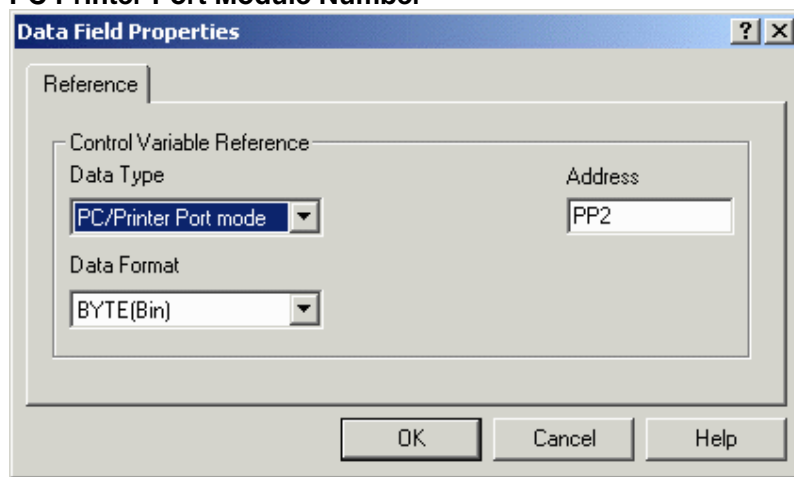

This variable provides information about the status of the PC/Printer Port assignment.

Value	Assignment
0	Assigned to Panel
1	Assigned to Internal Controller - User Mode
2	Assigned to Internal Controller - Service Mode

**PLC Port Module Number**

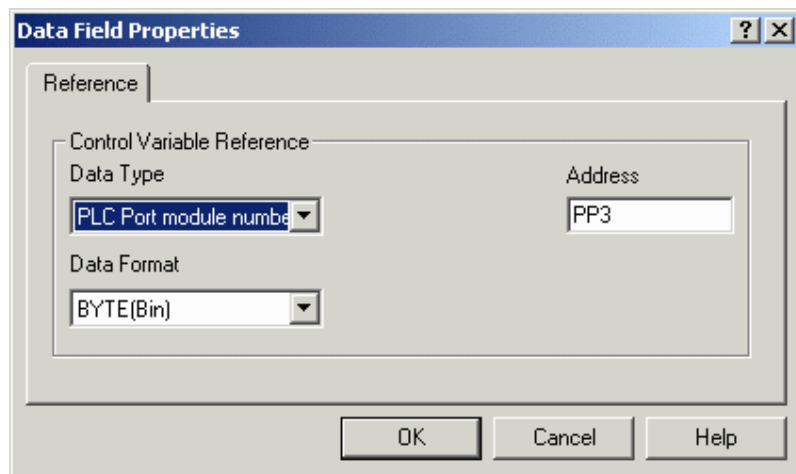

This variable provides information about the status of the PLC Port Module Number assignment.

Value	Assignment
7	Assigned to Panel
SCM03 Module Number	Assigned to Internal Controller - User Mode
SCM03 Module Number	Assigned to Internal Controller - Service Mode

Note: The SCM03 Module Number is the SCM03 Module address as displayed in the UniOP panel System Menu.

**PC Printer Port Mode**

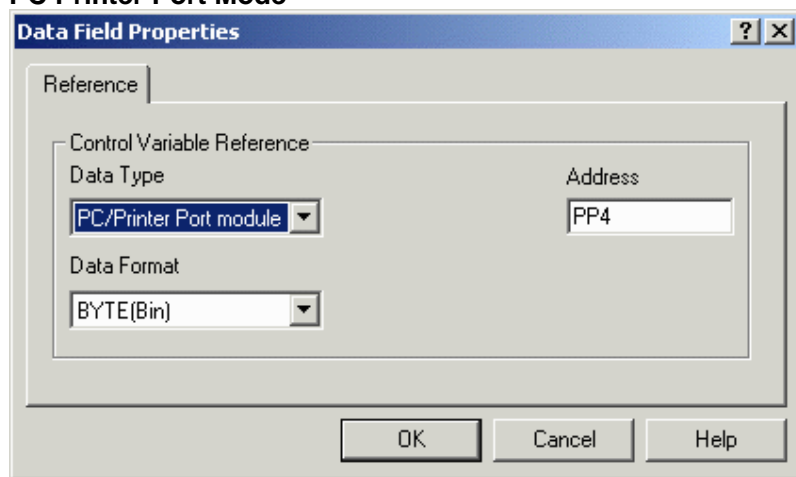

This variable provides information about the status of the PC/Printer Port Module Number assignment.

Value	Assignment
7	Assigned to Panel
SCM03 Module Number	Assigned to Internal Controller - User Mode
SCM03 Module	Assigned to Internal Controller - Service Mode

Number

Note: The SCM03 Module Number is the SCM03 Module address as displayed in the UniOP panel System Menu.

### Recipe

Data may be stored inside a panel in data retentive memory. The amount of data retentive memory available varies depending on the panel model. This data retentive memory can be used to permanently store data for use by an attached controller. This data can be written to the controller, and, conversely, the data can be read from the controller and then placed in the data retentive memory. This concept is termed "Recipes" and offers a powerful way to extend the capabilities of the controller. This is especially true for controllers that have a limited amount of internal memory. Some panel models do not support non-volatile recipe storage; please refer to specific product datasheets for more information.

Recipes are configured by adding the required controller data items to a page as recipe data fields. A recipe can be associated with a particular page and is composed of all the recipe data items on that page. Recipe data items contain all the information associated with normal controller data items, but rather than the data being read and written directly to the controller during the course of normal operation, the data is instead read from and written to the panel memory that is reserved for the data item. Only when you explicitly ask the panel to write data to the controller is the data sent to the controller. Similarly, only when you explicitly ask the panel to read data from the controller is the data actually read from the controller.

To configure recipe data field properties, either click on the appropriate icon in the toolbar or select Numeric/ASCII, Bargraph or Message from Insert - Data Fields, then use the cursor to specify the location of the item. In the Properties dialog box click the Recipe radio button under Reference and then click on the "..." button. See Data Field Properties for more information regarding the configuration of data field properties.

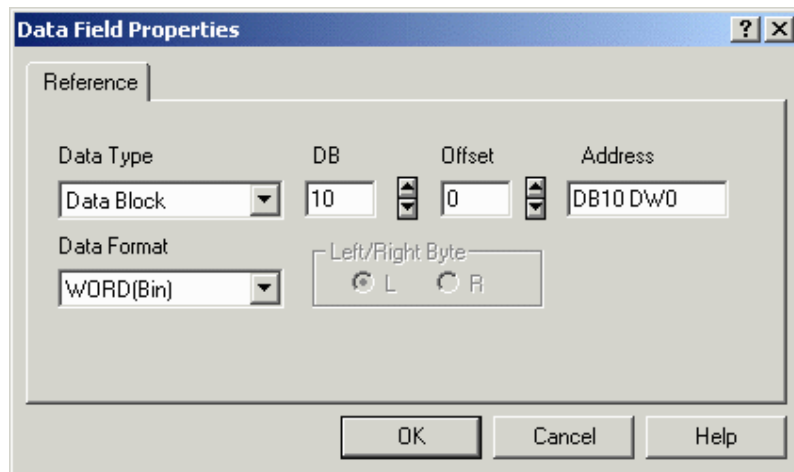

Note: In order to create a recipe for a data field, the Reference for that data field must be set to Recipe.

The Interlock MailBox offers a powerful way to control the operation of recipes from the controller. There are seven mailbox commands available to function with recipes:

Start Recipe Download

Start Recipe Upload

Recipe Status

Get Parameter Set Number

Set Parameter Set Number

Get Recipe Transfer Priority

Set Recipe Transfer Priority

The mailbox commands allow the choice of the recipe page and also of the parameter set. All mailbox commands related to recipes return a completion code describing the results of the operation. The mailbox interface to recipes is particularly useful if it is necessary to transfer a sequence of recipes to and/or from the panel.

A simple recipe example and a more complex recipe example are provided. Additional information about recipes is available.

Index

## Index

Indexed addressing mode lets you reference many controller memory locations from a single numeric field. This enables you to monitor the values of many memory locations while using only one field. An example of using indexed addressing is given.

To configure the indexed data field properties, either click on the appropriate icon in the toolbar or select Numeric/ASCII, Bargraph or Message under Insert - Data Fields, then use the cursor to specify the location of the item. In the Properties dialog box click the Index radio button under Reference and then click on the "..." button.

The Indirect Addressing Fields dialog box appears.

## Indirect Addressing Fields

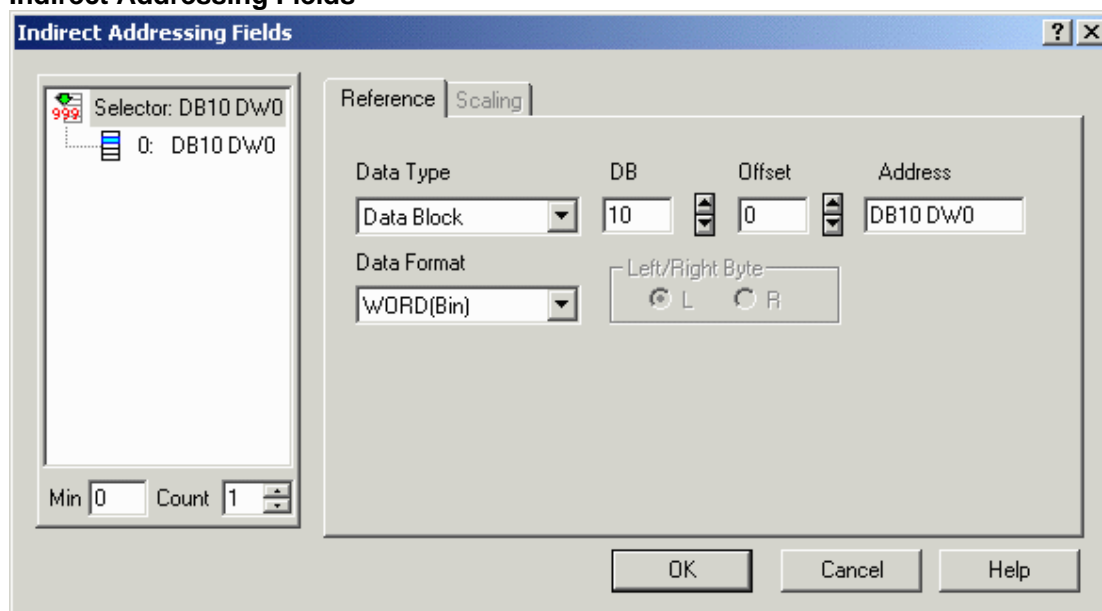

The Selector area lets you specify which controller memory location's contents will be displayed when a particular value is written. Please note that the memory locations are controller specific.

The Count determines the total number of locations listed, and Min (minimum) is the value of the first location listed.

The Reference section is similar to the Data Field Properties dialog box.

**Indexed Addressing Example**

*Indexed Addressing Example*

For this example, assume we have a plant in which industrial equipment is washed. The wash process is comprised of three stages. We want to be able to monitor the water temperature, the water pressure, the amount of time the equipment is in a particular stage, and the stage the process is in as shown in the figure below; all without pressing a key on the panel.

The numeric values will be written into the controller by the machine and will change constantly. The controller memory locations and their contents that we will use for this example are as follows:

DB10 DW0	Temperature in Stage 1 (ranges between 0 and 9999)
DB10 DW1	Temperature in Stage 2 (ranges between 0 and 9999)
DB10 DW2	Temperature in Stage 3 (ranges between 0 and 9999)
DB10 DW3	Pressure in Stage 1 (ranges between 0 and 9999)
DB10 DW4	Pressure in Stage 2 (ranges between 0 and 9999)
DB10 DW5	Pressure in Stage 3 (ranges between 0 and 9999)
DB10 DW6	Time in Stage 1 (ranges between 0 and 9999)
DB10 DW7	Time in Stage 2 (ranges between 0 and 9999)
DB10 DW8	Time in Stage 3 (ranges between 0 and 9999)
DB10 DW9	The stage the process is currently in (ranges between 1 and 3)

Note: The memory locations are controller specific; those listed above are done so only to be able to more easily explain the procedure of using indexed addressing. This example assumes that we have a Simatic S5 controller (set under Project - Configure Controller).

This example can be broken down into four basic steps:

Creating the Stage numeric field,

Creating the Temperature indexed addressing field,

Creating the Pressure indexed addressing field, and

Creating the Time indexed addressing field.

These fields are all related in that the values that are displayed within them are dependent upon the stage of the process. The indexed fields will be addressed in such a manner that whenever the field number is written into the Stage numeric field location (DB10 DW9), the corresponding information will be displayed in each of the indexed fields. For example, when

a value of 2 is written into DB10 DW9, each of the indexed fields will display the corresponding data: the temperature in stage 2, the pressure in stage 2, and the amount of time spent in stage 2.

*Creating the Stage Numeric Data Field*

Type the text labels (shown in black) onto a blank project page to resemble the figure above.

To insert the Stage, we must create a numeric data field on the screen to display the stage number. Select Insert - Data Fields - Numeric/ASCII, or click on the Numeric Field icon in the toolbar.

Use the cursor to define an area where the data field will be placed next to the text Stage Number.

The Numeric Field Properties box appears.

Under Size on the General tab set the field width to 1, since this field only needs to display a single digit.

Set the Reference as PLC and click the "..." button to specify the controller location.

In the Data Field Properties dialog box, set the address to DB10 DW9.

Click OK to return to the Numeric Field Properties dialog box.

Click OK to close the dialog box and return to the project page where a single 9 now appears next to Stage Number as a placeholder.

*Creating the Temperature Indexed Field*

Next we need to create a field on the screen where the temperature information for the process can be displayed. Select Insert - Data Fields - Numeric/ASCII, or click on the Numeric Field icon in the toolbar.

Use the cursor to define an area where the data field will be placed below the Temp label.

The Numeric Field Properties box appears.

Under Size on the General tab set the field width to 4, since the maximum value of this field is 9999.

Set the Reference as Index and click the "..." button to specify the controller location.

The Indirect Addressing Fields dialog box appears. Since there are three temperature values that we wish to monitor, enter the Count as 3. In the Selector list box on the left side of the Indirect Addressing Fields dialog box, three memory locations will be listed with the values 0, 1, and 2 (since we left the Min value as 0). They will all initially show the same memory location of DB10 DW0.

Since we want the first value to display the temperature in stage 1 (with value located in DB10 DW0), the value of entry 0 is referenced to the default value of DB10 DW0.

Since we want the second value to display the temperature in stage 2 (with value located in DB10 DW1), the value of entry 1 (the second entry) is referenced to the value of DB10 DW1. Enter the address DB10 DW1 into the Address Reference portion of the dialog box.

Click on entry 1 in the Selector list. The memory location for entry 1 changes to DB10 DW1.

To display the temperature in stage 3, enter the address DB10 DW2 into the Address Reference portion of the dialog box.

Click on entry 2 in the Selector list. The memory location for entry 2 changes to DB10 DW2. The dialog box will resemble that shown below.

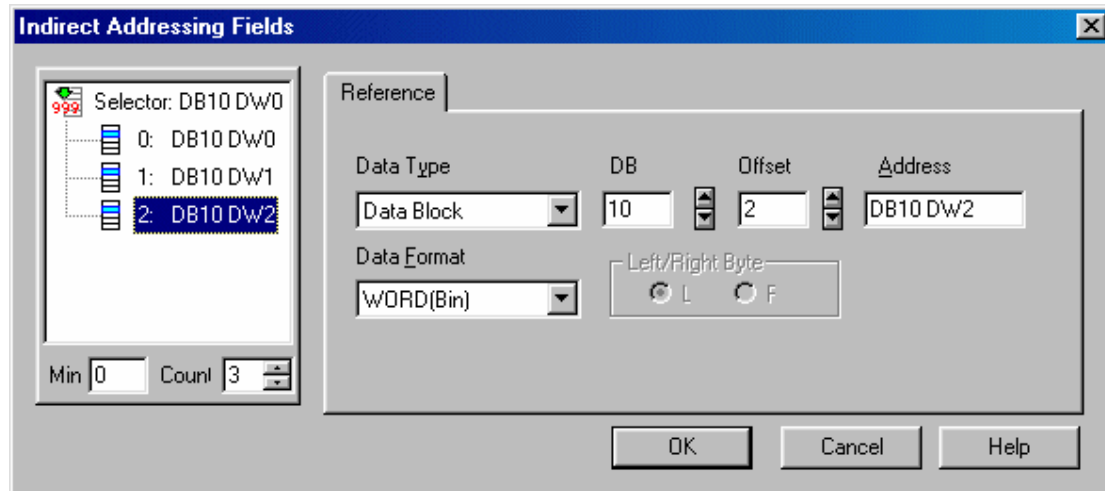

Click OK to return to the Numeric Field Properties dialog box.

Click OK to close the dialog box and return to the project page where "Is" now appears under the Temp label placeholders.

#### *Creating the Pressure Indexed Field*

Next we need to create a field on the screen where the pressure information for the process can be displayed. Select Insert - Data Fields - Numeric/ASCII, or click on the Numeric Field icon in the toolbar.

Use the cursor to define an area where the data field will be placed below the Pressure label.

The Numeric Field Properties box appears.

Under Size on the General tab set the field width to 4, since the maximum value of this field is 9999.

Set the Reference as Index and click the "..." button to specify the controller location.

The Indirect Addressing Fields dialog box appears. Since there are three pressure values that we wish to monitor, enter the Count as 3. In the Selector list box on the left side of the Indirect Addressing Fields dialog box, three memory locations will be listed with the values 0, 1, and 2 (since we left the Min value as 0). They will all initially show the same memory location.

To display the pressure in stage 1, enter the address DB10 DW3 into the Address Reference portion of the dialog box.

Click on entry 0 in the Selector list. The memory location for entry 0 changes to DB10 DW3.

To display the pressure in stage 2, enter the address DB10 DW4 into the Address Reference portion of the dialog box.

Click on entry 1 in the Selector list. The memory location for entry 1 changes to DB10 DW4.

To display the pressure in stage 3, enter the address DB10 DW5 into the Address Reference portion of the dialog box.

Click on entry 2 in the Selector list. The memory location for entry 2 changes to DB10 DW5. The dialog box will resemble that shown below.

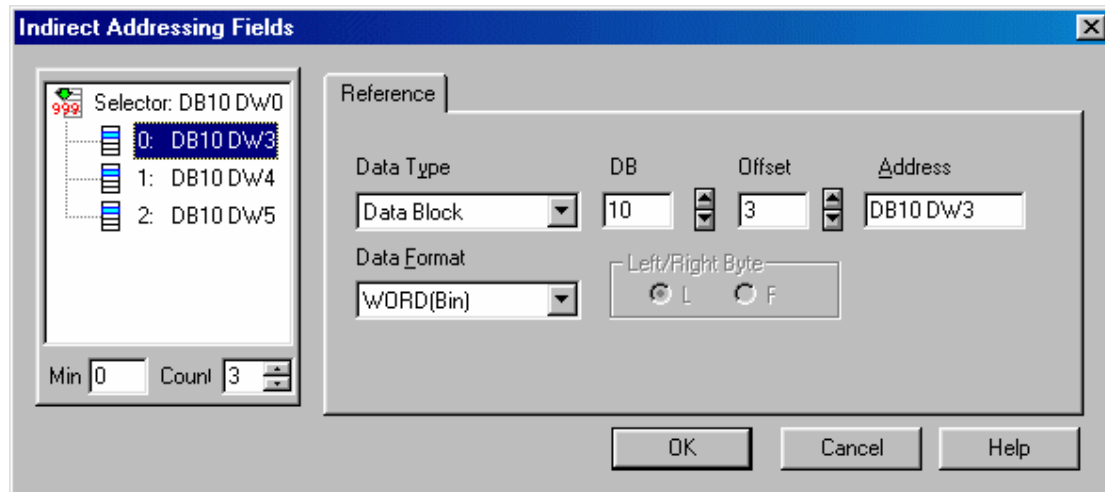

Click OK to return to the Numeric Field Properties dialog box.

Click OK to close the dialog box and return to the project page where "Is" now appears under the Pressure label placeholders.

#### *Creating the Time Indexed Field*

Finally, we need to create a field on the screen where the time information for the process can be displayed. Select Insert - Data Fields - Numeric/ASCII, or click on the Numeric Field icon in the toolbar.

Use the cursor to define an area where the data field will be placed below the Time label.

The Numeric Field Properties box appears.

Under Size on the General tab set the field width to 4, since the maximum value of this field is 9999.

Set the Reference as Index and click the "..." button to specify the controller location.

The Indirect Addressing Fields dialog box appears. Since there are three time values that we wish to monitor, enter the Count as 3. In the Selector list box on the left side of the Indirect Addressing Fields dialog box, three memory locations will be listed with the values 0, 1, and 2 (since we left the Min value as 0). They will all initially show the same memory location.

To display the time in stage 1, enter the address DB10 DW6 into the Address Reference portion of the dialog box.



Click on entry 0 in the Selector list. The memory location for entry 0 changes to DB10 DW6.

To display the time in stage 2, enter the address DB10 DW7 into the Address Reference portion of the dialog box.

Click on entry 1 in the Selector list. The memory location for entry 1 changes to DB10 DW7.

To display the time in stage 3, enter the address DB10 DW8 into the Address Reference portion of the dialog box.

Click on entry 2 in the Selector list. The memory location for entry 2 changes to DB10 DW8. The dialog box will resemble that shown below.

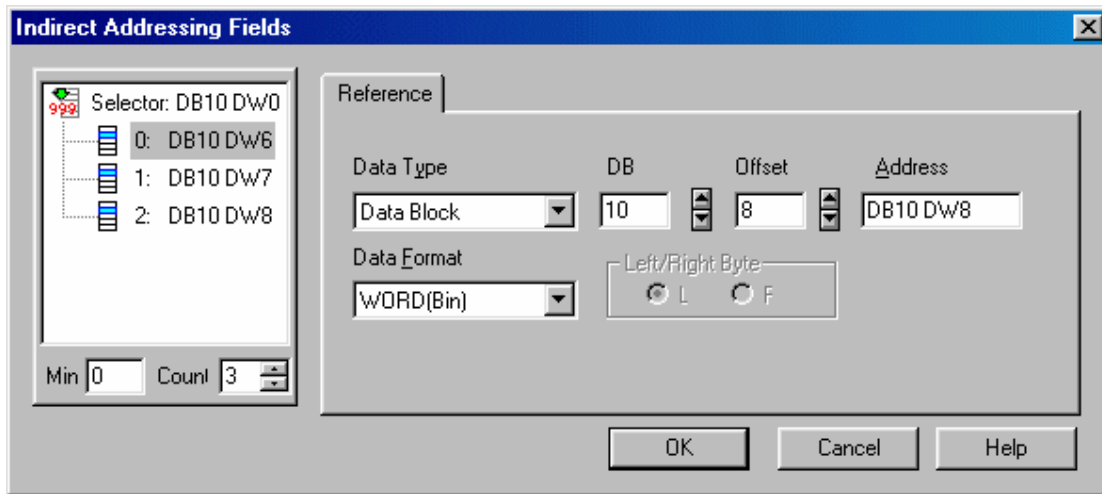

Click OK to return to the Numeric Field Properties dialog box.

Click OK to close the dialog box and return to the project page where "Is" now appears under the Time label placeholders.

#### 4.4.15 Text tab

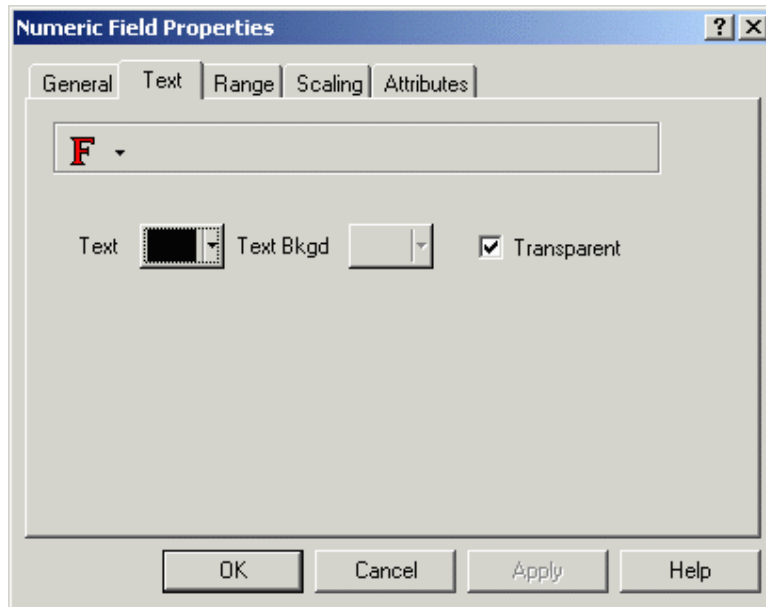

The Text tab allows you to set the font size and color, and the background color and transparency of a data item. Designer will not let you select a size that is too large to be displayed in the designated area. If Transparent is selected then text background colors are not available.

#### 4.4.16 Range

#### 4.4.17 Range tab

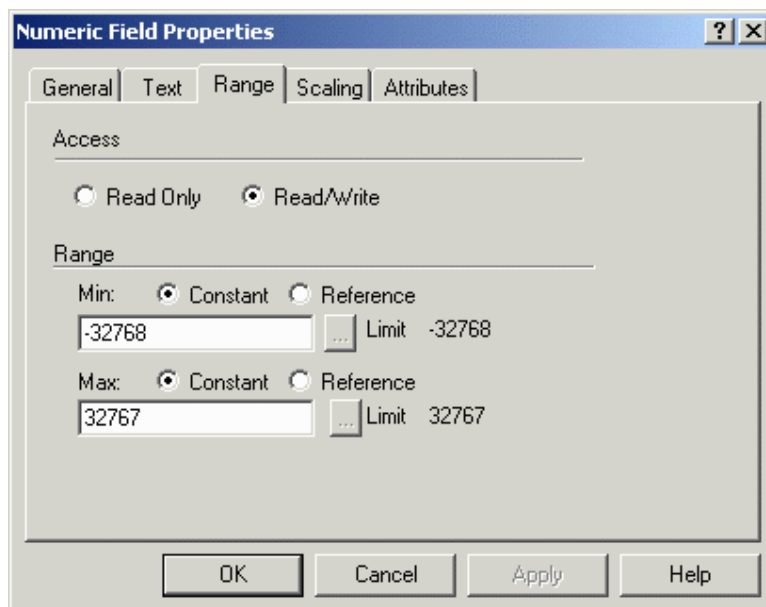

The Range tab lets you specify whether access to the project will be read only, or if read/write access will be allowed. If read/write access is allowed, then you can also specify the minimum and maximum value range.

#### 4.4.18 Access

This determines if the data field is to be read only or read/write. Keep in mind that if read only is selected, the field can only monitor the data in the controller. If read/write is selected, you can monitor data in the controller, as well as write data to the controller.

#### 4.4.19 Range

Minimum and maximum values can be configured for the read/write field only. These are lower and upper bounds to the data. If a value occurs outside of this range, asterisks will appear on the panel, and the previous value of the field will be displayed.

It is possible to attach the minimum and maximum values to memory locations in the controller. When dynamic references are required for the minimum/maximum values, then select Reference under Range. Upon doing so, the Data Field Properties dialog box appears, allowing you to specify the memory location.

Note: Once you have decided to use dynamic variable references for the min/max values, all the variables associated with the dynamic references must be assigned to memory locations in the controller.

When using dynamic variable references for the min/max limit settings, you can select how the UniOP panel retrieves these values. Selecting Project - Panel Setup and clicking on the Settings index tab will reveal a checkbox called Update PLC References. If this checkbox is marked, the dynamic variable references will be updated on a continuous basis. If this checkbox is unmarked, the dynamic variable references will be updated only after a page change when the destination page contains variable reference fields.

Note: When the continuous mode is used to get dynamic variable references from the controller, communication performance can be reduced due to the increasing number of variables being transmitting through the communication channel between the UniOP panel and the controller.

## 4.4.20 Scaling

### 4.4.21 Scaling tab

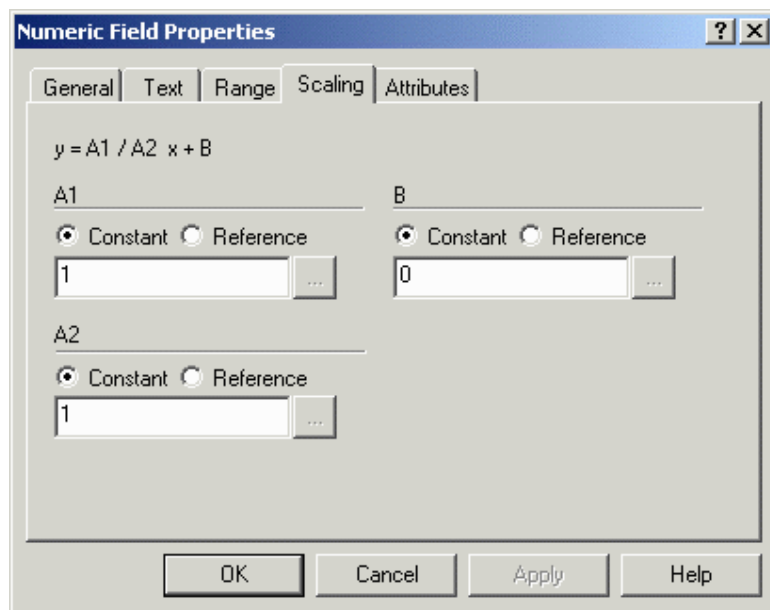

Scaling lets you change the appearance of the values being displayed onto the panel. For example, if the controller is reporting values in Celsius but the operator is familiar with Fahrenheit, performing a scaling operation on the data can convert it, with the result being displayed in Fahrenheit. With this option, any data from the controller can be manipulated however you wish.

The scaling equation is defined as:

$$y = (A1 / A2) x + B$$

Where,

y = Scaled value displayed

x = Controller data value

A1, A2, B = Scaling operators (these are the three entry boxes located within the scaling equation)

There are two important concepts to understand about scaling. First and foremost, the scaling operators (A1, A2, and B) are 16 bit integers. Internal calculations are done using 32 bit arithmetic, which allows the panel to report a more precise result than if it were using only 16 bit arithmetic.

Secondly, the maximum and minimum fields refer to the scaled value, not the value that is in the controller.

Two examples of using scaling are provided. The first is an example in which a user has a Celsius temperature in the controller and wishes to display a Fahrenheit temperature on the UniOP panel. The second is an example in which a user has a controller memory location that can range in value from 0 to 4095. Depending upon the value in the controller, you may wish to display that value as a percentage of the maximum possible value on the panel.

#### 4.4.22 Scaling Examples

##### **Scaling Example 1**

Assume that we have a controller that displays the temperature of a motor in Celsius. The person operating the UniOP panel is only familiar with temperatures in the Fahrenheit scale. By using scaling, we can have the Celsius temperature from the controller appear as a Fahrenheit temperature on the display panel.

Select Insert - Data Fields - Numeric/ASCII, or click on the Numeric Field icon in the toolbar.

Use the cursor to define an area where the data field will be placed.

The data field Properties box appears.

On the General tab, select the Reference as PLC and click the "..." button to specify the controller location.

Click OK to return to the data field Properties dialog box.

Click the Scaling tab.

We know that to convert a value from Celsius to Fahrenheit, we need to multiply the Celsius temperature by 9/5 and add 32 to the result. Consider the scaling equation:  $y = (A1/A2) x + B$ . Since  $x$  is the Celsius temperature in the controller, this is the value we want to multiply by 9/5. To do this, we would need to set A1 equal to 9 and A2 equal to 5. Make sure that the Constant button is checked for all values, and enter the value 9 for A1 and the value 5 for A2.

Adding 32 to this value can be done by setting B equal to 32, so enter 32 as the value for B.

Click OK to confirm this operation. The value displayed on the panel will be in Fahrenheit, while the controller data will be in Celsius.

##### **Scaling Example 2**

Assume that we have a controller memory location for which the numeric value can range from 0 to 4095. We want to display the actual value in the controller as a percentage of the maximum value.

Select Insert - Data Fields - Numeric/ASCII, or click on the Numeric Field icon in the toolbar.

Use the cursor to define an area where the data field will be placed.

The data field Properties box appears.

On the General tab, select the Reference as PLC and click the "..." button to specify the controller location. Click OK to return to the data field Properties dialog box.

Click the Scaling tab.

Since we want to display the actual value in the controller as a percentage of the maximum value, we need to use scaling. If the actual value in the controller is 0, then the panel should display 0. If the actual value in the controller is 4095, the panel should display 100. Simply divide the value in the controller by the maximum possible value and multiply this result by

100 to turn it into a percentage. Make sure that the Constant button is checked for all values, and enter the value 100 for A1, 4095 for A2, and 0 for B.

Click OK to confirm this operation. The value displayed on the panel will be a percentage of the actual numeric value.

#### 4.4.23 Attributes

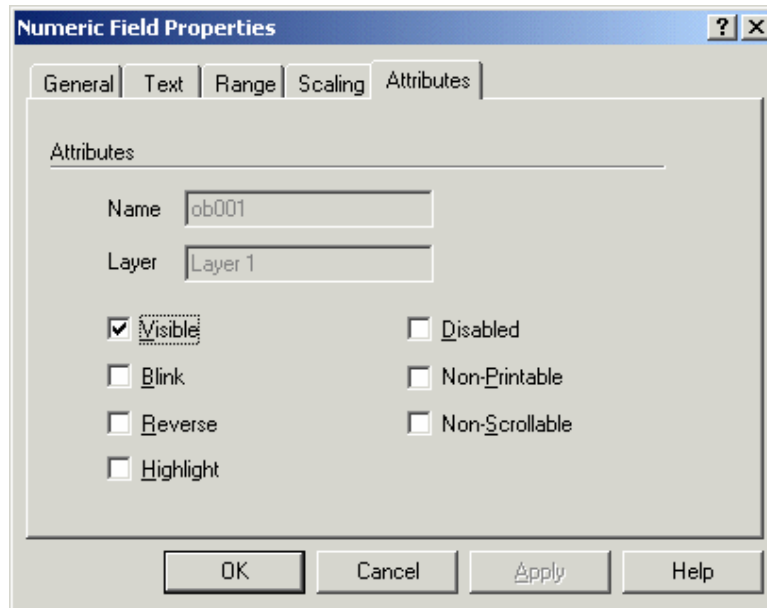

Use this tab to control the display / print attribute of the Numeric/ASCII Data Field.

#### 4.4.24 Numeric Data Field Example

Select Insert - Data Fields - Numeric/ASCII, or click on the Numeric Field icon in the toolbar.

Use the cursor to define an area where the data field will be placed.

The Numeric Field Properties box appears.

On the General tab, select the Reference as PLC and click the "..." button to specify the controller location. Click OK to return to the Numeric Field Properties dialog box.

Click OK.

A placeholder of 9's appears.

#### 4.4.25 ASCII Data Field Example

Select Insert - Data Fields - Numeric/ASCII, or click on the Numeric Field icon in the toolbar.

Use the cursor to define an area where the data field will be placed.

The Numeric Field Properties box appears.

Under Style select ASCII.

On the General tab, select the Reference as PLC and click the "..." button to specify the controller location. Click OK to return to the Numeric Field Properties dialog box.

Click OK.

A placeholder of A's appears.

## 4.4.26 Bargraph

### 4.4.27 Bargraph Data Fields

Bargraphs provide a visual representation of a controller value. To create a bargraph field, either select the Bargraph icon from the toolbar or select Insert - Data Fields - Bargraph. Then use the cursor to define the area in which the message field is to be placed. The Bargraph Field Properties dialog box will appear.

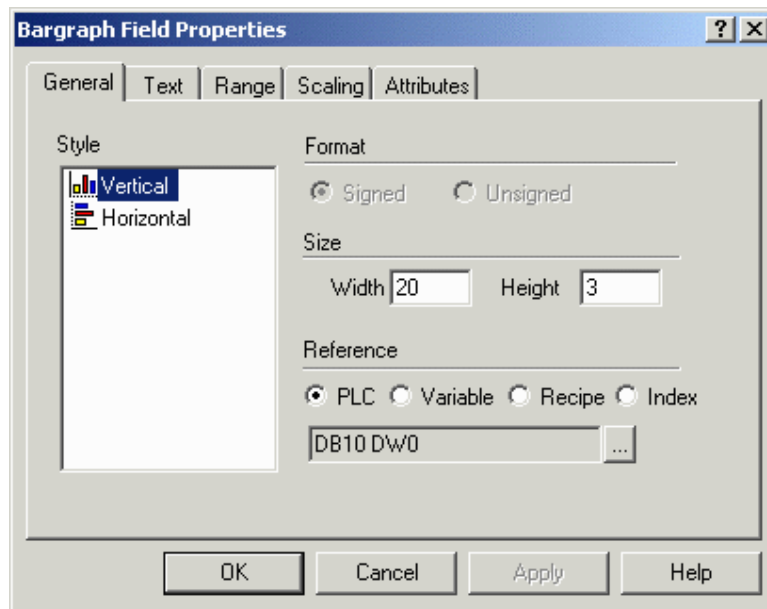

A number of items can be configured from this dialog box. These include:

Style (vertical or horizontal)

Display format

Field dimensions

Reference

Text properties

Data access (read only, read/write field)

Min. & max. values (read/write field only)

Data scaling

The Bargraph dialog box lets you create a bargraph and specify the controller memory location that the bargraph is to monitor. The maximum value of the field is represented when the bargraph is full. Likewise, the minimum value is represented when the bargraph is empty.

An external small window allows to Preview the Bargraph.

#### 4.4.28 Bargraph Preview



The bargraph Preview dialog box displays a basic bargraph of the appropriate orientation (horizontal or vertical) and size (width and height).

#### 4.4.29 General

#### 4.4.30 General tab

The Style, Format, and Size portions of this dialog box are not controller specific. These areas are used to instruct the panel in the manner in which to display the data. The Reference area is controller specific.

#### 4.4.31 Style

Bargraphs can be presented either vertically or horizontally.

#### 4.4.32 Format

The Format area allows you to format the data field. The availability of Format options will vary according to the capabilities of your controller.

Options are Signed or Unsigned data format. Supposing the variable's data area has a length of N bits, if the Unsigned option is chosen the variable is interpreted as an integer ranging from 0 to  $2^N - 1$ . If the Signed option is chosen the variable is interpreted as a two complement integers ranging from  $-2^{N-1}$  to  $2^{N-1} - 1$ . These choices are only active when the specified controller supports signed/unsigned data format.



#### 4.4.33 Size

These entry boxes define the size of the bargraph field.

Note: The field width/height cannot exceed the width/height of remaining panel from the current cursor row/column position.

Note: Size is adjusted depending on the current font size. Double font takes twice the width/height of regular font size, etc.

#### 4.4.34 Reference

The Reference area is the memory location in the controller to be used, and is dependent upon the type of controller selected. The field data type, data format, and address reference are all configured in this area. Only the items pertaining to the controller type and file type will be configurable.

The address chosen in the Reference section is dynamically linked to the bargraph. In other words, the value of the register corresponds to the fill level of the bargraph.

Reference choices for bargraph data fields include PLC, Variable, Recipe, and Index.

#### 4.4.35 Text tab

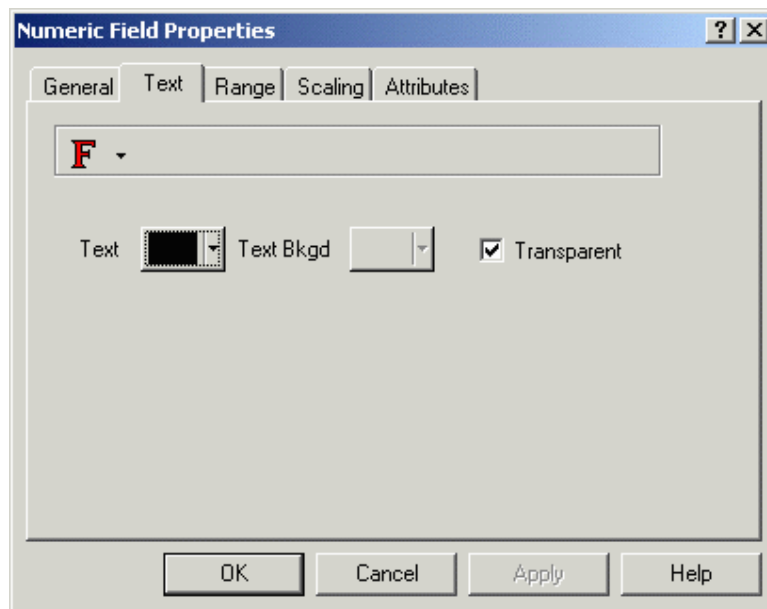

The Text tab allows you to set the font size and color, and the background color and transparency of a data item. Designer will not let you select a size that is too large to be displayed in the designated area. If Transparent is selected then text background colors are not available.

#### 4.4.36 Range tab

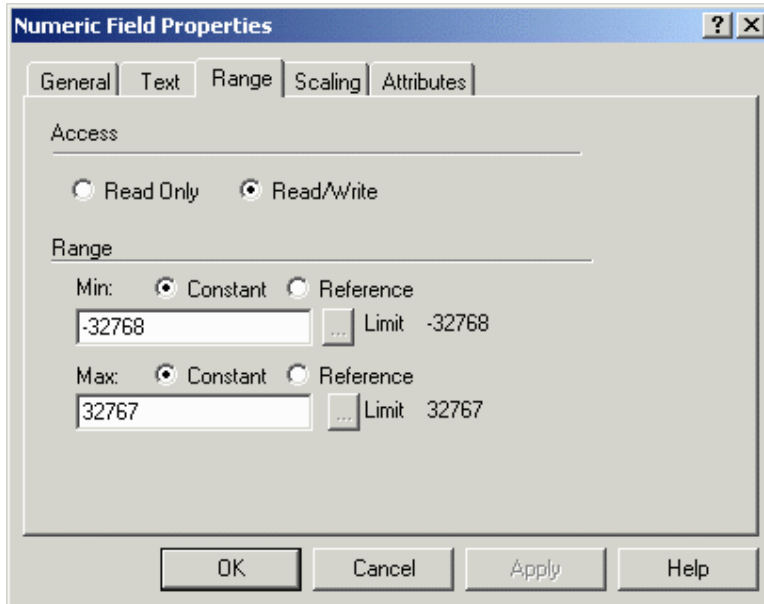

The Range tab lets you specify whether access to the project will be read only, or if read/write access will be allowed. If read/write access is allowed, then you can also specify the minimum and maximum value range.

#### 4.4.37 Scaling tab

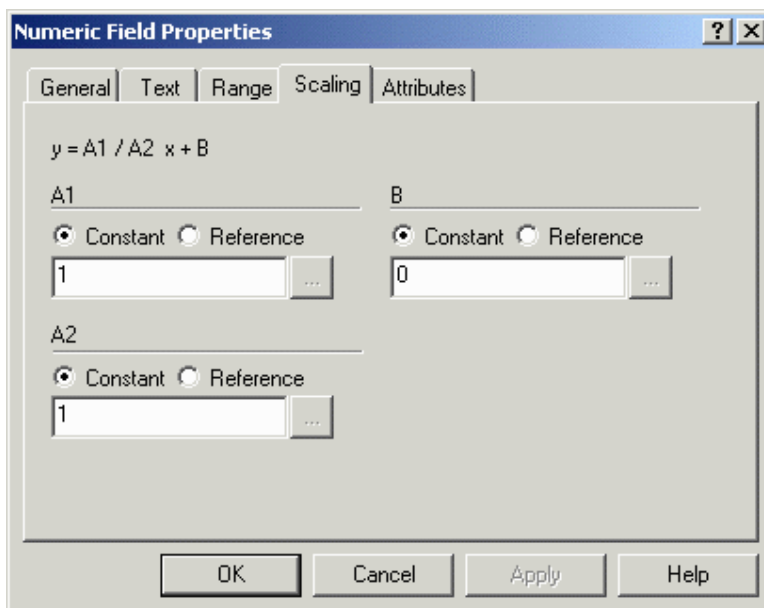

Scaling lets you change the appearance of the values being displayed onto the panel. For example, if the controller is reporting values in Celsius but the operator is familiar with Fahrenheit, performing a scaling operation on the data can convert it, with the result being displayed in Fahrenheit. With this option, any data from the controller can be manipulated however you wish.

The scaling equation is defined as:

$$y = (A1 / A2) x + B$$

Where,

y = Scaled value displayed

x = Controller data value

A1, A2, B = Scaling operators (these are the three entry boxes located within the scaling equation)

There are two important concepts to understand about scaling. First and foremost, the scaling operators (A1, A2, and B) are 16 bit integers. Internal calculations are done using 32 bit arithmetic, which allows the panel to report a more precise result than if it were using only 16 bit arithmetic.

Secondly, the maximum and minimum fields refer to the scaled value, not the value that is in the controller.

Two examples of using scaling are provided. The first is an example in which a user has a Celsius temperature in the controller and wishes to display a Fahrenheit temperature on the UniOP panel. The second is an example in which a user has a controller memory location that can range in value from 0 to 4095. Depending upon the value in the controller, you may wish to display that value as a percentage of the maximum possible value on the panel.

#### **4.4.38 Bargraph Example**

Assume we want to simulate the fill level of a tank. In this case, a transparent graphic of a tank could be used along with a bargraph to simulate the fill level. The procedure is as follows:

Click on the Graphics tab in the workspace.

Select Tanks from the pull-down list at the top of the workspace.

Click on the image of a tank and drag it to the project page.

Select Insert - Data Fields - Bargraph.

Use the cursor to outline an area on top of the tank for the bargraph.

Select Vertical as the bargraph Style.

Select PLC as the Reference type and click on the "..." button to set the memory location for the fill level value in the Data Field Properties dialog box.

Click OK to return to the Bargraph Field Properties dialog box.

Click on the Text tab and make sure that Transparent is selected.

Click OK.

The bargraph now appears on top of the tank and will reflect the fill level value.

#### 4.4.39 Message

#### 4.4.40 Message Data Fields

Message fields can be used instead of numerical values to inform the user that an event is occurring. For example, assume the message "Voltage too high" is attached to the value 32. Whenever the value of the register in the controller reaches 32, the message will be displayed. In this manner, a text message is displayed on the panel, which is often more beneficial and meaningful to the operator than displaying a numerical value.

Note: The maximum number of messages that can be displayed is 1024.

Message fields can be created in one of two ways. Either select the Text Message icon from the toolbar or select Insert - Data Fields - Message, then use the cursor to define the area in which the message field is to be placed. Once the message field is created the Text Message Properties dialog box will appear.

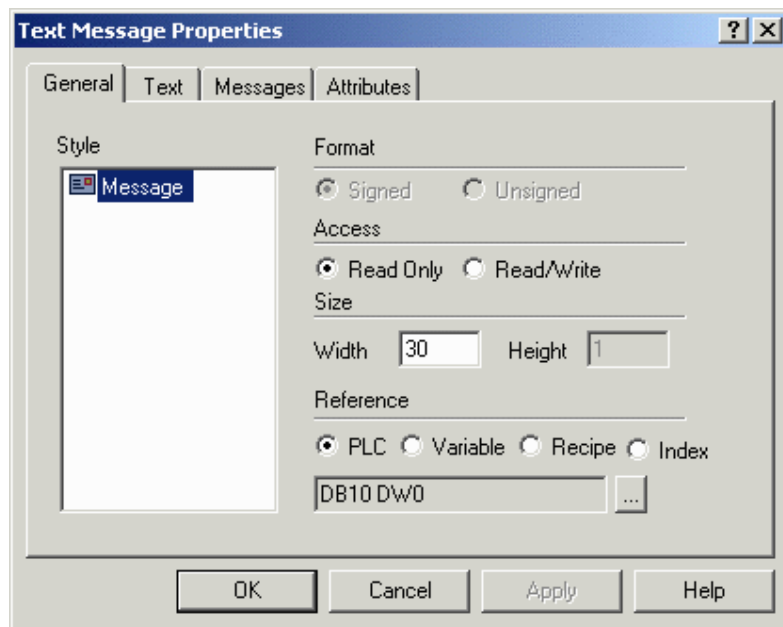

A number of items can be configured from this dialog box. These include:

Style

Field dimensions

Reference configuration

Text properties, and

Messages

An external small window allows to Preview the Message.

#### 4.4.41 Preview



The message field is represented by M's in the panel.

#### 4.4.42 General

##### 4.4.43 General tab

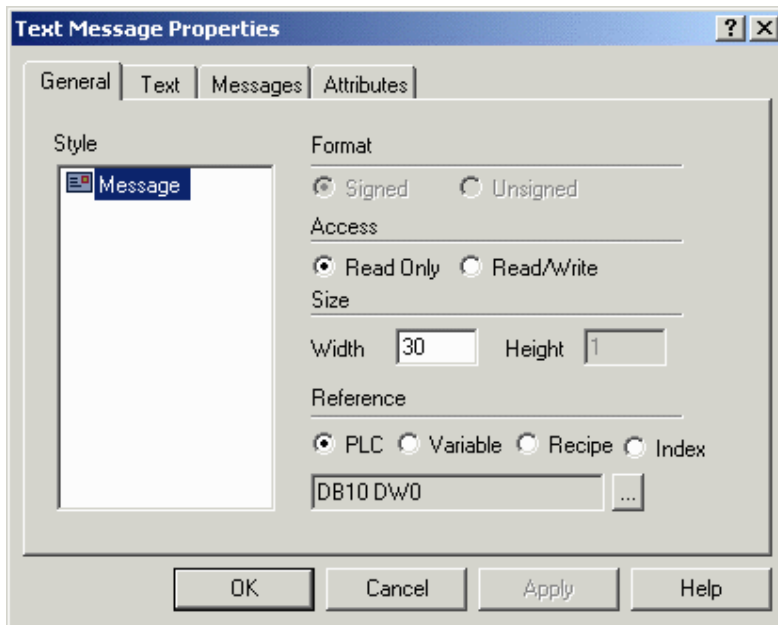

The Style and Size portions of this dialog box are not controller specific. These areas are used to instruct the panel in the manner in which to display the data. The Reference area is controller specific.

## 4.4.44 Style

Message is the only style choice available.

## 4.4.45 Size

These entry boxes define the size of the message field. The width and height of the field is equivalent to the maximum number of characters the message field can contain.

Note: The field width/height cannot exceed the width/height of remaining panel from the current cursor row/column position.

Note: Size is adjusted depending on the current font size. Double font takes twice the width/height of regular font size, etc.

## 4.4.46 Reference

The Reference area is the memory location in the controller to be used, and is dependent upon the type of controller selected. The field data type, data format, and address reference are all configured in this area. Only the items pertaining to the controller type and file type will be configurable.

Reference choices for message data fields include PLC, Variable, Recipe, and Index.

## 4.4.47 Text tab

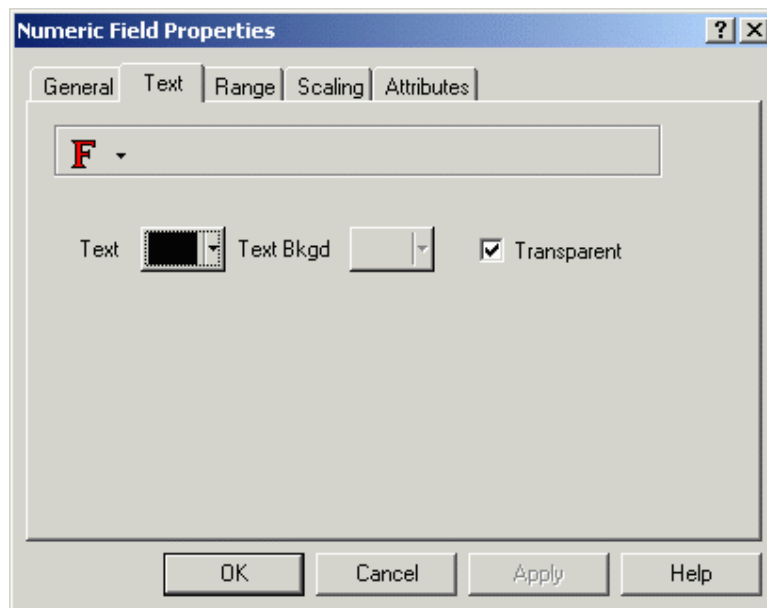

The Text tab allows you to set the font size and color, and the background color and transparency of a data item. Designer will not let you select a size that is too large to be displayed in the designated area. If Transparent is selected then text background colors are not available.

## 4.4.48 Messages

### 4.4.49 Messages tab

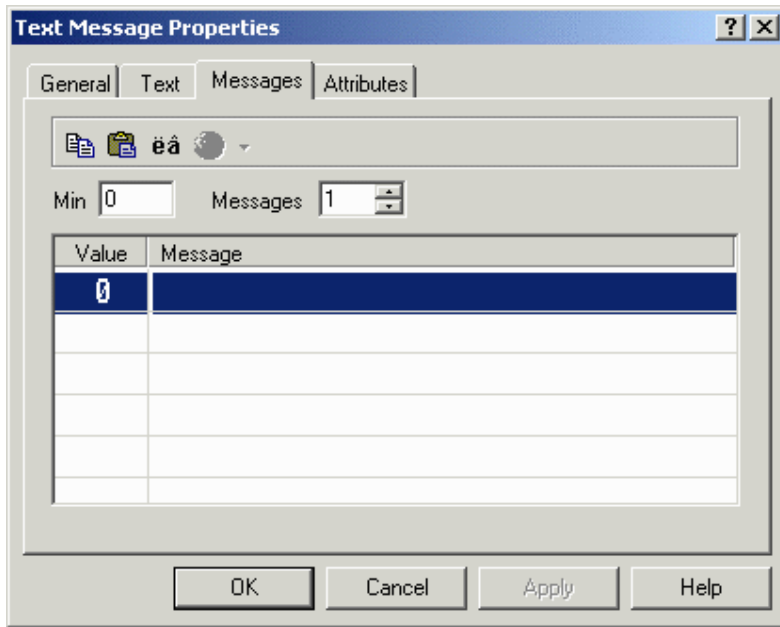

Message parameters (minimum and number of messages) can be configured on the Messages tab, and the messages can be entered.

The Minimum setting determines the Value of the initial message. Once the parameters are configured, begin entering messages for the different data values.

### 4.4.50 Minimum

The Minimum setting determines the Value of the initial message.

### 4.4.51 Number of Messages

The number of messages to be displayed is set by the Messages value.

### 4.4.52 Message Table

Once the parameters (minimum and number of messages) are configured, begin entering messages for the different data values.

### 4.4.53 Toolbar Options

#### Message Toolbar

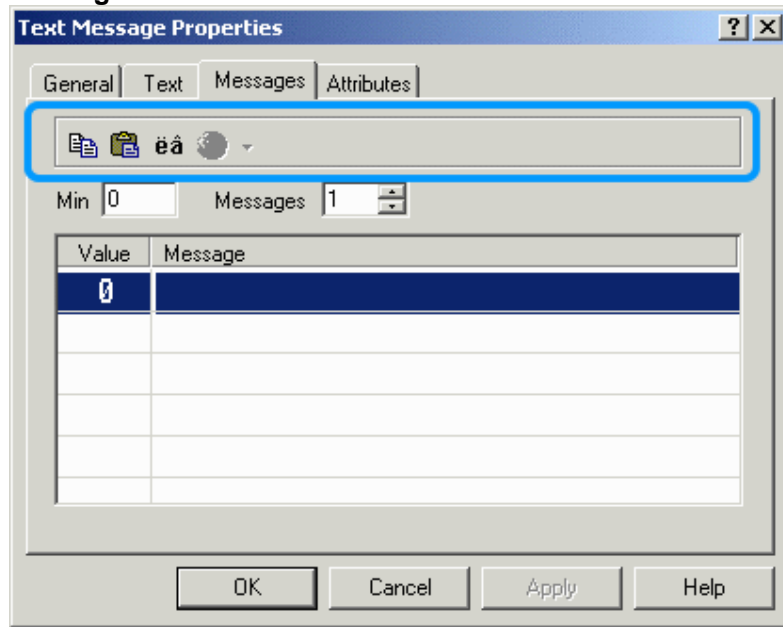

Various icons on the messages toolbar keep tools within easy reach. They include Copy, Paste, Special Characters, and Languages.

#### Copy

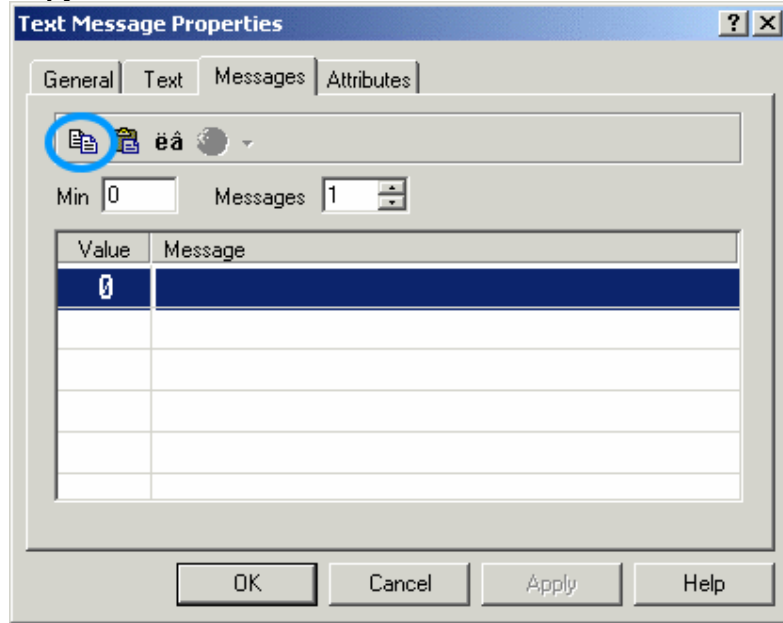

The familiar Windows™ features Copy and Paste are available for use in editing messages. If you have several messages that are similar, you can use the Copy and Paste features to copy messages and then make any necessary changes.

Simply select which messages to copy by highlighting them. If you want to copy several messages that are in successive order, click on the first one and drag the mouse down until



the last one is highlighted and release the mouse button. If you have several messages to copy that are not in successive order, hold down the Ctrl key, click on each of the messages that you want to copy, and release the Ctrl key. All of these methods will select the text to be copied. Next, click on the Copy icon to copy the messages into Windows™ Clipboard. Then use the Paste feature to copy the messages into their new locations.

You can also use a Windows™-based text editor, such as Notepad, to create a list of messages. To do this, place each message on a separate line. Use the copy function of the editor to copy the text to the clipboard and then use the paste feature to copy the messages into their new locations.

### Paste

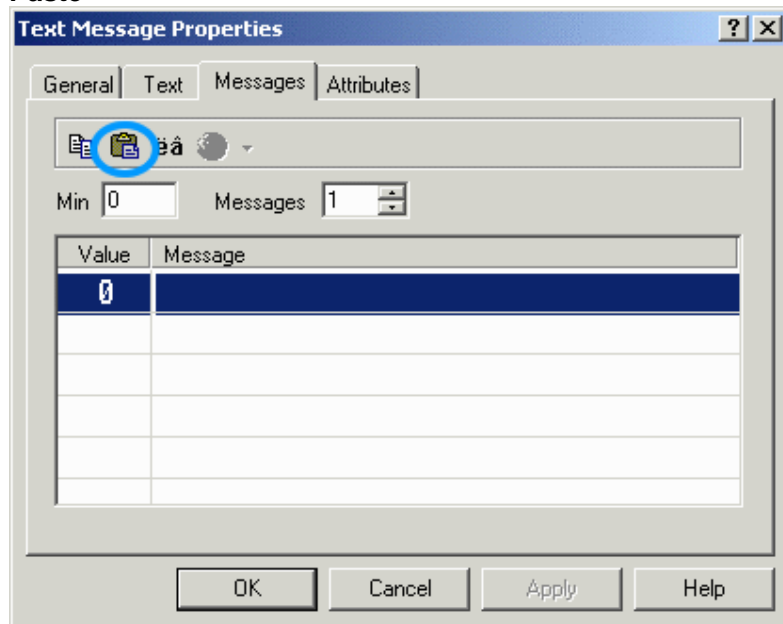

The familiar Windows™ features Copy and Paste are available for use in editing messages. If you have several messages that are similar, you can use the Copy and Paste features to copy messages and then make any necessary changes.

First Copy a message as described in the Copy section. Highlight the message number where you want to paste the first message and click on Paste to copy the message into its new location.

### Special Characters

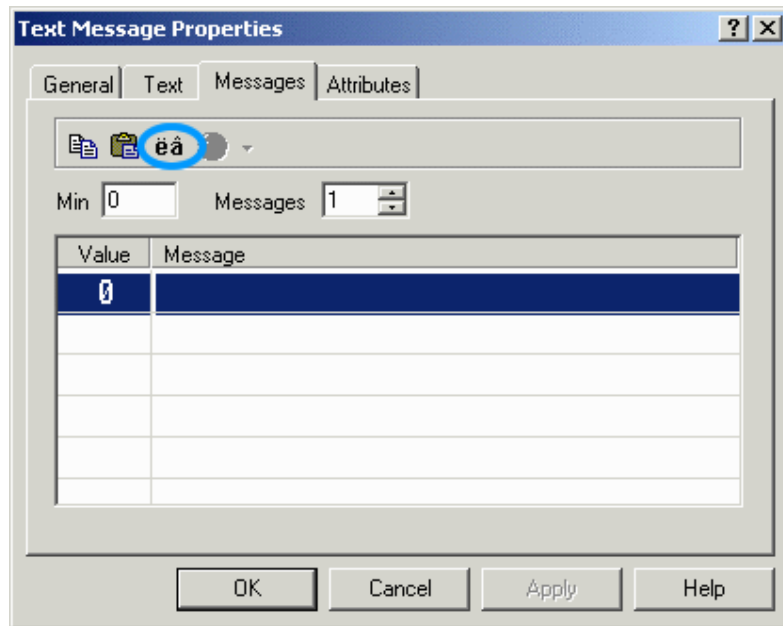

Special characters may be added to text by clicking on the Special Characters button. This will bring up the Special Characters dialog box in which you can select the character(s) to be used by double clicking on them or by single clicking on them and pressing Insert. The characters will appear in the last position the cursor was in before entering the special characters dialog box.

### Select Language

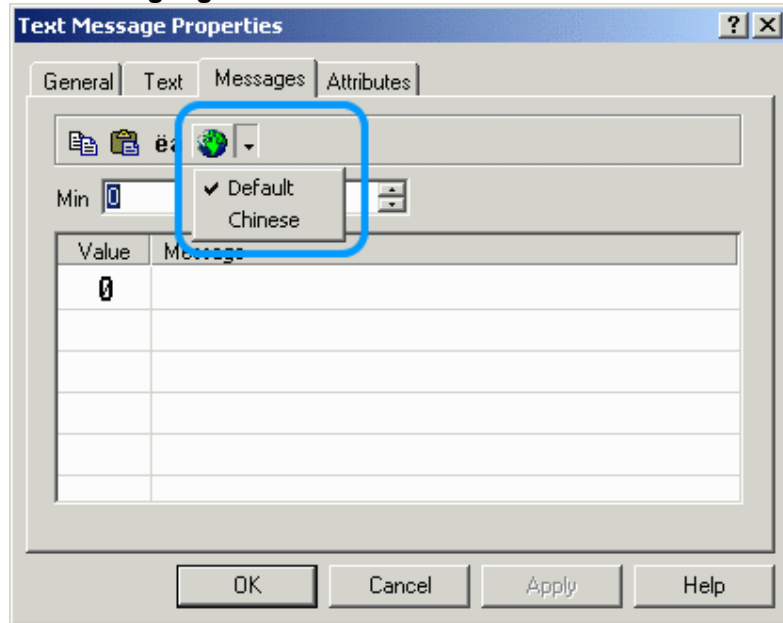

Select a language from the pull-down list. If the language you wish to use is not in the list, it may be created by clicking the Languages icon on the toolbar or by selecting Languages from the Project menu.

## 4.4.54 Message Example

Select Insert - Data Fields - Message.

Use the cursor to outline an area for the message.

Select PLC as the Reference type and click on the "..." button to set the memory location for the messages in the Data Field Properties dialog box.

Click OK to return to the Message Field Properties dialog box.

Click on the Text tab and set the fonts and colors.

Click on the Messages tab. Set the number of messages.

Enter the messages.

Click OK.

## 4.4.55 Attribute

### 4.4.56 Attribute Data Fields

Occasionally it is necessary to draw attention to a particular part of the screen or to indicate the increased importance of a message or data field. For these instances, dynamic and static attributes are provided.

To create an Attribute field, either select the Attribute icon from the toolbar or select Insert - Data Fields - Attribute. Then use the cursor to define the area in which the attribute field is to be placed. The Attribute Properties dialog box will appear.

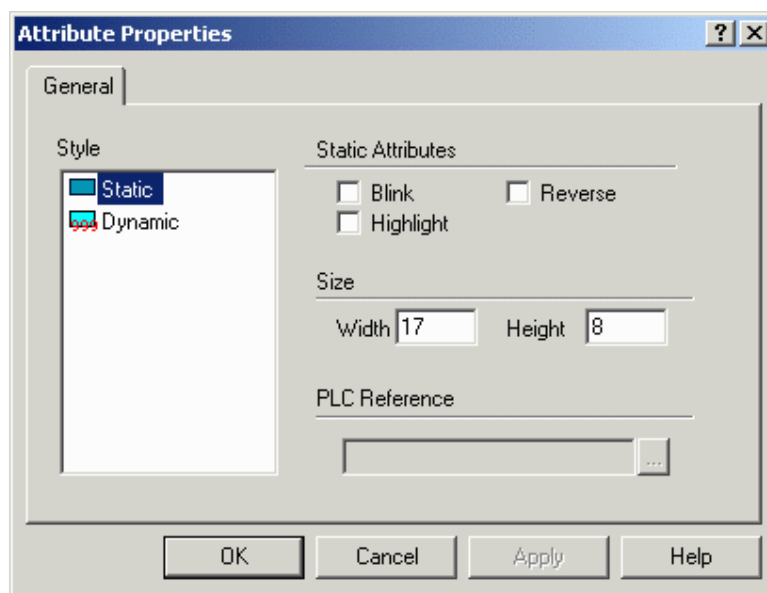

A number of items can be configured from this dialog box. These include:

Style (static or dynamic)

Static Attributes (static attributes only)

Field dimensions

PLC Reference (dynamic attributes only)

#### 4.4.57 Style

Static attributes and dynamic attributes are the two choices available.

#### 4.4.58 Static Attributes

If Static is selected as the Style, any combination of the blink, reverse, and highlight attributes may be used. These attributes let you make an area of the screen stand out by highlighting the area, reversing the area, or making the area blink.

#### 4.4.59 Dynamic Attributes

If Dynamic is selected as the Style, the screen attribute will be fixed to a value of a word or bit in the controller.

The address of the controller's memory location can be entered in the PLC Reference area.

If the attribute is referenced to a word, the attribute will be dependent upon the three least significant bits in the controller's memory location.

Decimal Value	Bit 2	Bit 1	Bit 0	Attribute
0	0	0	0	Normal
1	0	0	1	Blinking
2	0	1	0	Highlight
4	1	0	0	Reverse

If the attribute is referenced to a bit, there will be no attribute displayed when the bit has the value of 0. The blink attribute will be displayed whenever the bit has a value of 1.

Note: Keep in mind that not all attributes are supported on every panel.

#### 4.4.60 Color Attributes

All color panels support a new type of dynamic attribute field that will allow the user to dynamically control the color of an area on the display. The color attributes have been introduced as an extension to the existing monochrome dynamic attributes (blink, reverse and highlight).

The word in the controller memory referenced by the dynamic attribute will be interpreted as shown in the table below.

Bit 0, 1, 2	Monochrome Attribute
Bit 3	C (this enables color attribute mode)
Bit 4, 5, 6, 7	Not used
Bit 8, 9, 10, 11 = B0-B3	Background color
Bit 12, 13, 14, 15 = F0-F3	Foreground color

C is the bit that enables the color attribute mode. The Color attributes are interpreted according to the table below.

C=0, Color Attributes Disabled

C=1, Color Attributes Enabled

Decimal Value	Bit 3	Bit 2	Bit 1	Bit 0	Color
0	0	0	0	0	Black
1	0	0	0	1	Dark Red
2	0	0	1	0	Dark Green
3	0	0	1	1	Dark Yellow
4	0	1	0	0	Dark Blue
5	0	1	0	1	Dark Magenta
6	0	1	1	0	Dark Cyan
7	0	1	1	1	Dark Gray
8	1	0	0	0	Light Gray
9	1	0	0	1	Red
10	1	0	1	0	Green
11	1	0	1	1	Yellow
12	1	1	0	0	Blue
13	1	1	0	1	Magenta
14	1	1	1	0	Cyan
15	1	1	1	1	White

Note that the Foreground color and the Background color can be independently controlled.

UniOP firmware 4.20 or later is required to support dynamic color attributes.

#### 4.4.61 256 Color Attributes

Panel firmwares 4.30 and greater are supporting the 256 colors mode for the dynamic attributes. The 256 colors mode can be enabled by setting to 1 the bit 4 of the LS Byte of the color attribute. When this bit is set panel read a double word, instead of a word only, to retrieve the entire colors information.

**When 16Colors is selected on panel setting**

PLC word (16 Colors palette)

(1)		LS Byte (0)							
FG	BG					C	R	H	B

**When 256Colors is selected on panel setting**

PLC dword (16 Colors palette)

(3)	(2)	(1)		LS Byte (0)						
		FG	BG			0	C	R	H	B

PLC dword (256 Colors palette)

(3)	(2)	(1)		LS Byte (0)						
FG	BG					1	C	R	H	B

Below tables show the correspondence from the color index to use inside the color attribute and the RGB color to show on the panel.

Index	Colors			Index	Colors		
	R	G	B		R	G	B
0	0	0	0	32	44	0	0
1	0	0	128	33	44	0	128
2	0	0	192	34	44	0	192
3	0	0	255	35	44	0	255
4	0	44	0	36	44	44	0
5	0	44	128	37	44	44	128
6	0	44	192	38	44	44	192
7	0	44	255	39	44	44	255
8	0	86	0	40	44	86	0
9	0	86	128	41	44	86	128
10	0	86	192	42	44	86	192
11	0	86	255	43	44	86	255
12	0	128	0	44	44	128	0
13	0	128	128	45	44	128	128
14	0	128	192	46	44	128	192
15	0	128	255	47	44	128	255
16	0	166	0	48	44	166	0
17	0	166	128	49	44	166	128
18	0	166	192	50	44	166	192
19	0	166	255	51	44	166	255
20	0	192	0	52	44	192	0
21	0	192	128	53	44	192	128
22	0	192	192	54	44	192	192
23	0	192	255	55	44	192	255
24	0	224	0	56	44	224	0
25	0	224	128	57	44	224	128
26	0	224	192	58	44	224	192
27	0	224	255	59	44	224	255
28	0	255	0	60	44	255	0
29	0	255	128	61	44	255	128
30	0	255	192	62	44	255	192
31	0	255	255	63	44	255	255

Index	Colors			Index	Colors		
	R	G	B		R	G	B
64	86	0	0	96	128	0	0
65	86	0	128	97	128	0	128
66	86	0	192	98	128	0	192
67	86	0	255	99	128	0	255
68	86	44	0	100	128	44	0
69	86	44	128	101	128	44	128
70	86	44	192	102	128	44	192
71	86	44	255	103	128	44	255
72	86	86	0	104	128	86	0
73	86	86	128	105	128	86	128
74	86	86	192	106	128	86	192
75	86	86	255	107	128	86	255
76	86	128	0	108	128	128	0
77	86	128	128	109	128	128	128
78	86	128	192	110	128	128	192
79	86	128	255	111	128	128	255
80	86	166	0	112	128	166	0
81	86	166	128	113	128	166	128
82	86	166	192	114	128	166	192
83	86	166	255	115	128	166	255
84	86	192	0	116	128	192	0
85	86	192	128	117	128	192	128
86	86	192	192	118	128	192	192
87	86	192	255	119	128	192	255
88	86	224	0	120	128	224	0
89	86	224	128	121	128	224	128
90	86	224	192	122	128	224	192
91	86	224	255	123	128	224	255
92	86	255	0	124	128	255	0
93	86	255	128	125	128	255	128
94	86	255	192	126	128	255	192
95	86	255	255	127	128	255	255



Index	Colors			Index	Colors		
	R	G	B		R	G	B
128	166	0	0	160	192	0	0
129	166	0	128	161	192	0	128
130	166	0	192	162	192	0	192
131	166	0	255	163	192	0	255
132	166	44	0	164	192	44	0
133	166	44	128	165	192	44	128
134	166	44	192	166	192	44	192
135	166	44	255	167	192	44	255
136	166	86	0	168	192	86	0
137	166	86	128	169	192	86	128
138	166	86	192	170	192	86	192
139	166	86	255	171	192	86	255
140	166	128	0	172	192	128	0
141	166	128	128	173	192	128	128
142	166	128	192	174	192	128	192
143	166	128	255	175	192	128	255
144	166	166	0	176	192	166	0
145	166	166	128	177	192	166	128
146	166	166	192	178	192	166	192
147	166	166	255	179	192	166	255
148	166	192	0	180	192	192	0
149	166	192	128	181	192	192	128
150	166	192	192	182	192	192	192
151	166	192	255	183	192	192	255
152	166	224	0	184	192	224	0
153	166	224	128	185	192	224	128
154	166	224	192	186	192	224	192
155	166	224	255	187	192	224	255
156	166	255	0	188	192	255	0
157	166	255	128	189	192	255	128
158	166	255	192	190	192	255	192
159	166	255	255	191	192	255	255

Index	Colors			Index	Colors		
	R	G	B		R	G	B
192	224	0	0	224	255	0	0
193	224	0	128	225	255	0	128
194	224	0	192	226	255	0	192
195	224	0	255	227	255	0	255
196	224	44	0	228	255	44	0
197	224	44	128	229	255	44	128
198	224	44	192	230	255	44	192
199	224	44	255	231	255	44	255
200	224	86	0	232	255	86	0
201	224	86	128	233	255	86	128
202	224	86	192	234	255	86	192
203	224	86	255	235	255	86	255
204	224	128	0	236	255	128	0
205	224	128	128	237	255	128	128
206	224	128	192	238	255	128	192
207	224	128	255	239	255	128	255
208	224	166	0	240	255	166	0
209	224	166	128	241	255	166	128
210	224	166	192	242	255	166	192
211	224	166	255	243	255	166	255
212	224	192	0	244	255	192	0
213	224	192	128	245	255	192	128
214	224	192	192	246	255	192	192
215	224	192	255	247	255	192	255
216	224	224	0	248	255	224	0
217	224	224	128	249	255	224	128
218	224	224	192	250	255	224	192
219	224	224	255	251	255	224	255
220	224	255	0	252	255	255	0
221	224	255	128	253	255	255	128
222	224	255	192	254	255	255	192
223	224	255	255	255	255	255	255

Example:

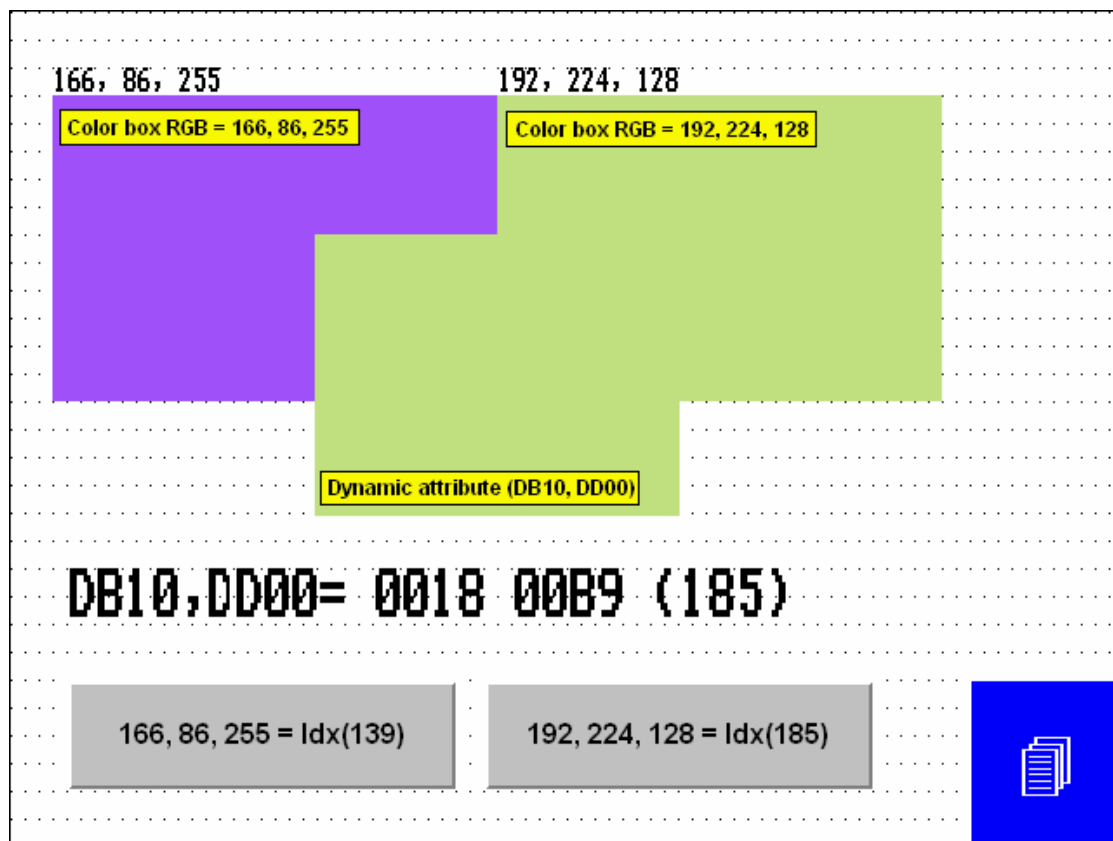

Note: 256 colors mode can be use only when the “256 Colors support for Object” is enabled (on the setting tab of the panel setup dialog box)

**Warning:**

Transparent text objects overlapped with dynamic color attributes are not supported. To avoid unexpected results, text objects over dynamic color attributes should no be transparent.

**4.4.62 Size**

These entry boxes define the size of the static or dynamic data field.

Note: The field width/height cannot exceed the width/height of remaining panel from the current cursor row/column position.

Note: Size is adjusted depending on the current font size. Double font takes twice the width/height of regular font size, etc.

#### 4.4.63 PLC Reference

The Reference area is the memory location in the controller to be used, and is dependent upon the type of controller selected. The field data type, data format, and address reference are all configured in this area. Only the items pertaining to the controller type and file type will be configurable. PLC is the only reference option.

#### 4.4.64 Attribute Example

Select Insert - Data Fields - Attribute.

Use the cursor to outline an area for the attribute.

Select Dynamic as the Style.

Click on the "..." button under PLC Reference to set the memory location in the Data Field Properties dialog box.

Click OK to return to the Attribute Properties dialog box.

Click OK.

#### 4.4.65 Dynamic Graphics

#### 4.4.66 Dynamic Graphics Data Fields

This feature lets you display graphics based upon a numeric value in the controller. For example, a user may want to display two graphics, one when a blower is on and one when a pump is on. Depending upon which machine is on, the respective graphic will be displayed at a single screen location. If neither machine is on, then no graphic will be displayed. In another scenario, a user may wish to have a graphic appear at a different location on the screen, depending upon which machine is on. Examples of both situation 1 and situation 2 described above are given.

It is possible to position dynamic graphics fields over static background bitmaps to create animated images. Transparent and three-dimensional touch cells can be defined over static bitmap images. To place a dynamic graphic over a static bitmap image, import a static bitmap image into a project, then create the dynamic graphic fields over the static bitmap.

Dynamic graphics may be inserted by either selecting Insert - Data Fields - Dynamic Graphics or by selecting the Dynamic Graphics icon from the toolbar. Use the cursor to specify the location of the item.

Once the dynamic graphics field is created, the Dynamic Graphics Properties dialog box will appear.

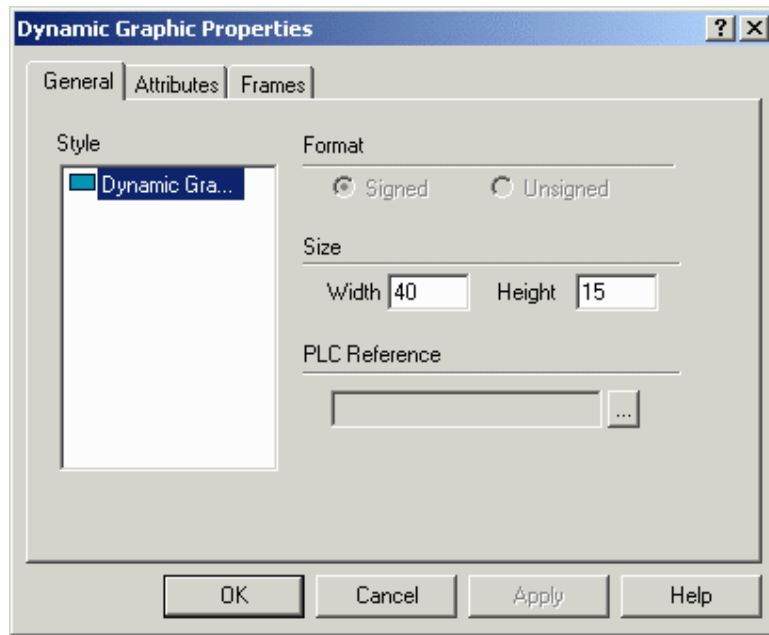

A number of items can be configured from this dialog box. These include:

Style,

Field dimensions,

PLC Reference, and

Frames properties.

An external small window allows to Preview of the Dynamic Graphic

Note: Dynamic graphics cannot fully overlap static bitmaps. The first columns cannot overlap at all.

Note: Dynamic graphics fields and the bitmaps under them must snap to the page's character-based grid.

Note: It is not possible to overlap two dynamic objects, since both items are dynamically changed by the controller. For example, a numeric field cannot be placed over a dynamic graphic field.

#### 4.4.67 Preview



Provides a snapshot view of an individual dynamic graphic frame.

#### 4.4.68 General

##### 4.4.69 General tab

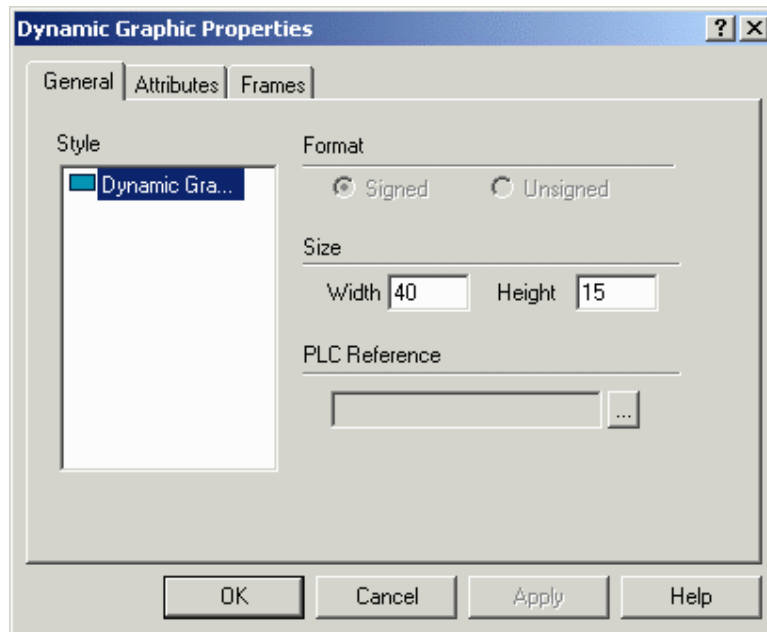

The Style and Size portions of this dialog box are not controller specific. These areas are used to instruct the panel in the manner in which to display the data. The Reference area is controller specific.

#### 4.4.70 Style

Dynamic Graphic is the only possible choice.

## 4.4.71 Size

The width and height of the graphic box, in pixels.

Note: The field width/height cannot exceed the width/height of remaining panel from the current cursor row/column position.

Note: Size is adjusted depending on the current font size. Double font takes twice the width/height of regular font size, etc.

## 4.4.72 PLC Reference

The Reference area is the memory location in the controller to be used, and is dependent upon the type of controller selected. The field data type, data format, and address reference are all configured in this area. Only the items pertaining to the controller type and file type will be configurable. PLC is the only reference option.

## 4.4.73 Frames

### 4.4.74 Frames Properties

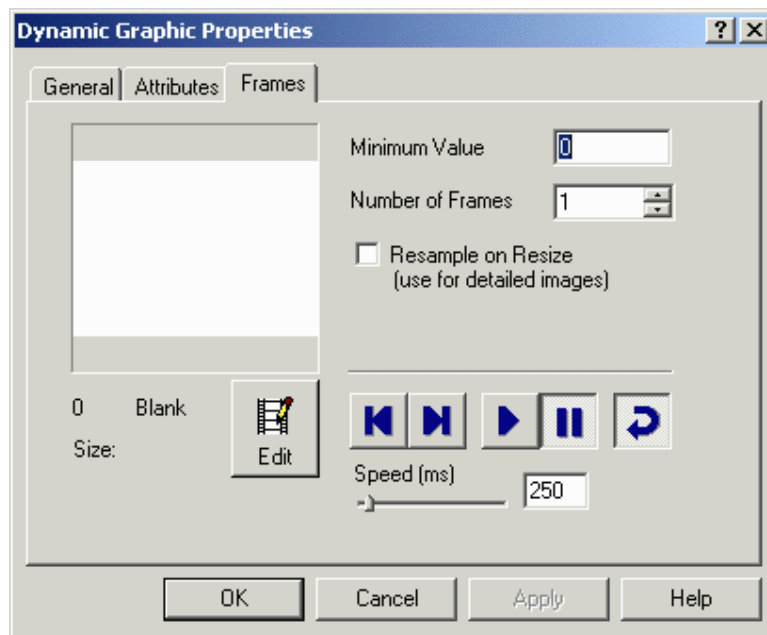

The Frames tab of the Dynamic Graphic Properties dialog box lets you configure the individual frames that comprise the dynamic graphic.

Enter a number in the Min box to establish the number of the first frame. Set the total number of frames in the Frames box. Users may toggle through the frames by using Display Previous Frame / Display Next Frame. To see the frames in a continuous loop, click the Play button. The play speed may be set by sliding the indicator or by entering a value in the box. Click the Stop button to stop the Play display.

Click the Edit button to edit the individual dynamic graphic frames.

#### 4.4.75 Edit Dynamic Graphics

##### Edit Dynamic Graphics

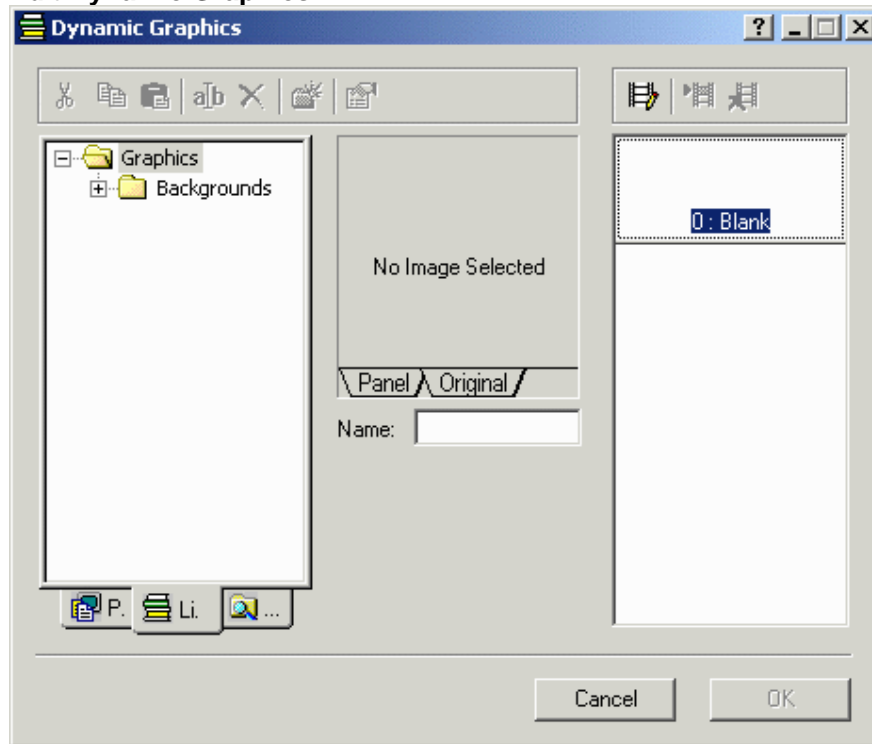

The Dynamic Graphics dialog box allows users to edit dynamic graphic frame. This box can be accessed by clicking the Edit button from the Frames tab of the Dynamic Graphics Properties dialog box.

Dynamic graphics may be selected from either the library of graphics provided with Designer as shown on the Library tab, or from another file on your system as shown on the Disk tab. An image selected from either source will appear on the Panel / Original tabs, where it may be renamed if necessary using the Name field. The Original tab displays the image in its original form for reference purposes, while the Panel tab displays the image as it will appear on the panel.

The various frames making up the dynamic graphic are displayed on the right side of the box. Three commands are available.

Modify Dynamic Graphic Frame is enabled when a user clicks on a frame that contains a dynamic graphic.

Replace Dynamic Graphic Frame is enabled when a dynamic graphic has been selected and is displayed in the Panel / Original tabs. When the Replace Dynamic Graphic Frame icon is clicked, the dynamic graphic currently displayed in the Panel / Original tabs is inserted into the currently selected frame to replace the current contents of the frame.



Delete Dynamic Graphic Frame is enabled when a user selects a non-empty dynamic graphic frame. Clicking on the Delete Dynamic Graphic Frame icon removes the dynamic graphic from that frame.

A number of familiar Windows™ commands are available in the Dynamic Graphics dialog box. These include Cut, Copy, Paste, Rename, Delete, and Insert Folder. An additional icon is available to edit the Properties of dynamic graphics, including Image and Panel properties.

### **Image**

The Image tab of the dynamic graphics Properties box lets you change image properties such as the type of dither, the contrast and brightness, to smooth, sharpen or blur the image, to invert, flip or mirror the image, or to size the image to fit the preview box. Close the box by clicking on the X in the upper right corner to accept the changes. The Reset button returns the graphic to the default settings.

### **Panel**

The Panel tab of the dynamic graphics Properties box lets you set panel color preferences. Close the box by clicking on the X in the upper right corner.

## **4.4.76 Dynamic Graphics Examples**

### **4.4.77 Dynamic Graphics Example 1**

In this example, assume a situation in which there are three possible occurrences in the same area of the screen: a blower can be on, a pump can be on, or neither can be on. A graphic will be displayed on the panel to reflect the situation. This can be accomplished by referencing the graphics to a single register in the controller. A value of 0 in this register indicates that neither the blower nor the pump is on. A value of 1 in this register indicates that the blower is on. A value of 2 in this register indicates that the pump is on.

Select Insert - Data Fields - Dynamic Graphics, or click on the Dynamic Graphics icon in the toolbar.

Use the cursor to define a box where the graphic is to be displayed.

The Dynamic Graphic Properties dialog box appears.

Click on the "..." button under PLC Reference to set the memory location in the Data Field Properties dialog box.

Set the data field properties, then click OK to return to the Dynamic Graphic Properties box.

Select the Frames index tab.

We have three different values being written into the controller: 0, 1, or 2. Therefore, our minimum value is 0 and the number of frames is 3. Enter 0 in the Min box and 3 in the Frames box.

Click on the Edit button.

This will bring up another dialog box in which you can associate a graphic with a value. The three frames are shown on the right of the dialog box, with their assigned values (0, 1, and

2).

Since we do not need a graphic for the value of 0 (remember, a 0 indicates that neither the pump nor the blower is operating), leave this frame blank.

Frame 1 needs to have a graphic associated with it to indicate that the blower is on. Click in frame 1 to select it. Since we are using graphics that are available from the Graphics Library Manager, click on the Library tab. If the graphics were not located in the Graphics Library Manager, we would need to click on the Disk tab and select the proper location of the graphic, as well as its filename.

Click on the graphics folders to open them, and select a graphic to represent the blower. (You can preview the various graphics by clicking on their filenames in the list. The image will appear in the preview window in the center of the dialog box, with the graphic name listed below. The Panel tab in the preview window shows how the graphic will appear on your panel, while the Original tab shows the appearance of the original file graphic.) Click on the Replace Dynamic Graphic Frame icon above the list of frames to select a graphic to represent the highlighted frame (frame 1). The graphic will be shown in the frame for frame 1.

Repeat Step 11 for frame 2, and select a graphic to represent a pump. Click on OK to return to the dialog box in which the address and number of frames were selected.

Click on OK from within this dialog box to complete the procedure and return to the project page.

#### **4.4.78 Dynamic Graphics Example 2**

In this example, we want to have a graphic appear in one of three different locations on the screen, depending upon what is happening. Assume there are four possible occurrences: a blower can be on, a pump can be on, both can be on, or neither can be on. If there is nothing on, the display screen will be blank. If the blower is on, the graphic of the blower will appear in the second screen location. If the pump is on, the graphic of the pump will appear in the third screen location. This can be accomplished by using a different memory location for each graphic that is to be displayed. If both the blower and the pump are on, then both will appear in their respective screen locations.

Since there is to be nothing displayed on the screen when neither the pump nor the blower is on, we only need to create two dynamic graphics fields in the project file - one field for the graphic of the blower and the other field for the graphic of the pump.

To create the first dynamic graphic field for the blower, select Insert - Data Fields - Dynamic Graphics, or click on the Dynamic Graphics icon in the toolbar.

Use the cursor to define a box where the graphic is to be displayed.

The Dynamic Graphic Properties dialog box appears.

Click on the "..." button under PLC Reference to set the memory location in the Data Field Properties dialog box.

Select the Frames index tab.

There are two different values that may be written into the controller: 0, 1. (Either the blower is off or it is on.) Therefore, our minimum value is 0 and the number of frames is 2. Enter 0 in the Min box and 2 in the Frames box.

Click on the Edit button.

This will bring up another dialog box in which you can associate a graphic with a value. The two frames are shown on the right of the dialog box, with their assigned values (0 and 1).

Since we do not need a graphic for the value of 0 (remember, a 0 indicates that neither the blower nor the pump is operating), leave this frame blank.

Frame 1 needs to have a graphic associated with it to indicate that the blower is on. Click in frame 1 to select it. Since we are using graphics that are available from the Graphics Library Manager, click on the Library tab. (Note that if the graphics were not located in the Graphics Library Manager, we would need to click on the Disk tab and select the proper location of the graphic, as well as its filename.)

Click on the graphics folders to open them, and select a graphic to represent the blower. (You can preview the various graphics by clicking on their filenames in the list. The image will appear in the preview window in the center of the dialog box, with the graphic name listed below. The Panel tab in the preview window shows how the graphic will appear on your panel, while the Original tab shows the appearance of the original file graphic.) Click on the Replace Dynamic Graphic Frame icon above the list of frames to select a graphic to represent the highlighted frame (frame 1). The graphic will be shown in the frame for frame 1.

Click on OK to return to the dialog box in which the address and the number of frames were selected.

Click on OK from within this dialog box to complete the procedure and return to the project page.

Repeat Steps 1-12 for the pump in a different location on the page.

#### **4.4.79 Time**

#### **4.4.80 Time Data Field**

This option is used to add a time data field to the current page in the format HH:MM:SS. To insert a time data field click on the Time Field icon from the toolbar, select Insert - Data Fields - Time, or use the Ctrl+T keys, then use the cursor to define the area in which the time field is to be placed. Once the time field is created a dialog box will appear where the text may be configured for displaying the time data field.

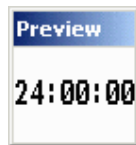
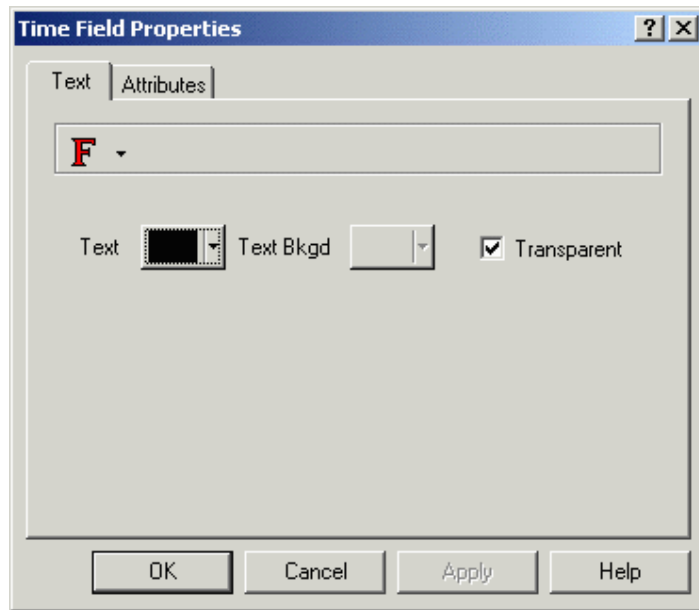

To change the time display from 12-hour format to 24-hour format, or vice versa, choose Panel Setup from the Project menu. Under the Settings tab there is a Time Format field where this setting may be changed.

#### 4.4.81 Time Data Field Example

Select Insert - Data Fields - Time.

Use the cursor to outline an area for the time data field.

Set the fonts and colors.

Click OK.

The time data field appears on the project page.

If you wish to change the time format, choose Panel Setup from the Project menu, and select the Settings tab. Make a selection from the Time Format list.

#### 4.4.82 Date

#### 4.4.83 Date Data Field

This option is used to add a date data field to the current page. To insert a date data field click on the Date Field icon on the toolbar, select Insert - Data Fields - Date, or use the

Ctrl+D keys, then use the cursor to define the area in which the date field is to be placed. Once the date field is created a dialog box will appear where the text may be configured for displaying the date data field.

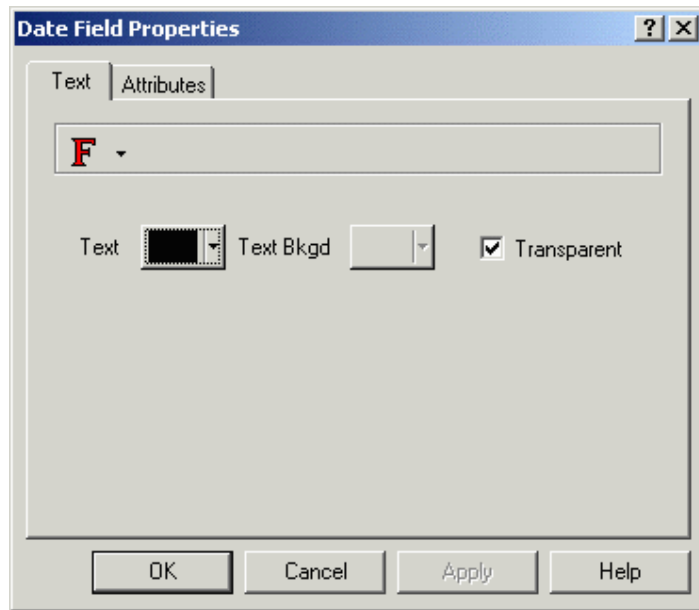

This field may be displayed in one of two formats: month/day/year or day/month/year. To change the date display format, choose Panel Setup from the Project menu. Under the Settings tab there is a Date Format field where this setting may be changed.

#### 4.4.84 Date Data Field Example

Select Insert - Data Fields - Date.

Use the cursor to outline an area for the date data field.

Set the fonts and colors.

Click OK.

The date data field appears on the project page.

If you wish to change the date format, choose Panel Setup from the Project menu, and select the Settings tab. Make a selection from the Date Format list.

#### 4.4.85 Touch Cells

#### 4.4.86 Touch Cells

A touch cell allows a panel user to interact with the panel. The user is able to touch a panel in an indicated position and receive a visual cue. The various types of touch cells available and their functionality are:

**Panel Key Button:** Used for creating a touch cell as a panel key (i.e., Enter). Panel keys represent all of the function keys, numeric keys, and arrow keys, as well as the help key, the clear key, the enter key, the +/- key, and the decimal point key.

**ASCII Key Button:** Used for creating a touch cell as an ASCII character.

**Push Button:** Used for creating a touch cell as a push button. These push buttons mimic mechanical push buttons in that one logic value represents open contacts and another logic value represents closed contacts.

**Illuminated Push Button:** Used for creating a touch cell as an illuminated push button. The only difference between an illuminated pushbutton and a pushbutton is that the face of the illuminated pushbutton can reflect the status of a bit in the PLC.

**Selector Switch:** Used for creating a touch cell as a 2, 3 or 4 position selector switch.

**Indicator Light:** Used for creating an indicator lamp.

**Generic Command Button:** Used for creating a touch cell as a panel key (i.e., Enter), macro command (i.e., show alarm list), or ASCII character.

To insert a touch cell click the appropriate touch cell icon on the toolbar or select a type of touch cell from the Touch Cells submenu in the Insert menu, then use the cursor to define the area in which the touch cell is to be placed. A dialog box will appear where the touch cell may be configured.

An example of using a touch cell to write to a controller is provided.

**Note:** To aid in programming, whenever a user touches a read/write numeric field, a keypad will appear, allowing them to enter data.

**Note:** Transparent and three-dimensional touch cells can be defined over static bitmap images.

#### 4.4.87 Touch Cell Preview Window

The Preview window lets you see how the touch cell will look before it is actually created and placed into a project file.

Clicking the left mouse button on the touch cell in the preview window simulates pressing the touch cell.

#### 4.4.88 Touch Cell / Keyboard Macro Editor Example

In this example, we will configure a touch cell to write a value to the controller. For this example, we will create a touch cell to simulate panel key F21. Then we will use the Keyboard Macro Editor to program the panel to write a value to the controller when panel key F21 is pressed.

Note: It is suggested that touch cells be programmed with a reversed attribute when they are pressed so that the operator will have immediate feedback.

Select Insert - Touch Cells - Panel Key Button.

Use the cursor to outline an area on the page where the touch cell will appear.

In the Panel Key Button Properties dialog box, select Rectangle as the Style.

Under Action, click on the "..." button to identify the Key that will control the touch cell action.

Click on key F21 to select it.

Click OK.

Select the Attributes tab and select Reverse to have the touch cell reverse color when it is pressed.

Select the Layout tab and select Red as the color for On, and Yellow as the color for Off.

In the Label box, type Write to Controller.

Click OK.

Select Keyboard Macro Editor from the Project menu.

On the Page n tab, select key F21. This will allow the touch cell to perform its assigned function only on this page in the project.

Make sure that Pressed is selected as the Key State.

Select the Attribute icon from within the Commands toolbar. Select the Reverse attribute. Since we already highlighted the area in which this attribute is to occur, the dimensions are set automatically.

Click OK.

The command "Attribute reverse at (location)" is listed for panel key F21.

It is necessary to set a small delay before turning off the attribute in order to give the panel user time to see the attribute. Select Wait from the Commands toolbar.

Enter a 3 in the dialog box that appears. This will add a 3/10 second delay.

The command "Wait for a 3/10 of a second" is listed.

Now we need to turn the attribute off. From the Commands toolbar, select Attribute again. Make sure that none of the attributes (Reverse, Highlight, Blink) are checked.

Click OK.

The command "Attribute clear at (location)" is listed.

From the Commands toolbar, select Write to Controller.

Specify the memory address in the Data Field Properties dialog box.

Click OK.

Enter a value to be written to the controller.

Click OK.

The command "Write value to Controller memory" is listed.

The macro screen should appear similar to that shown below.

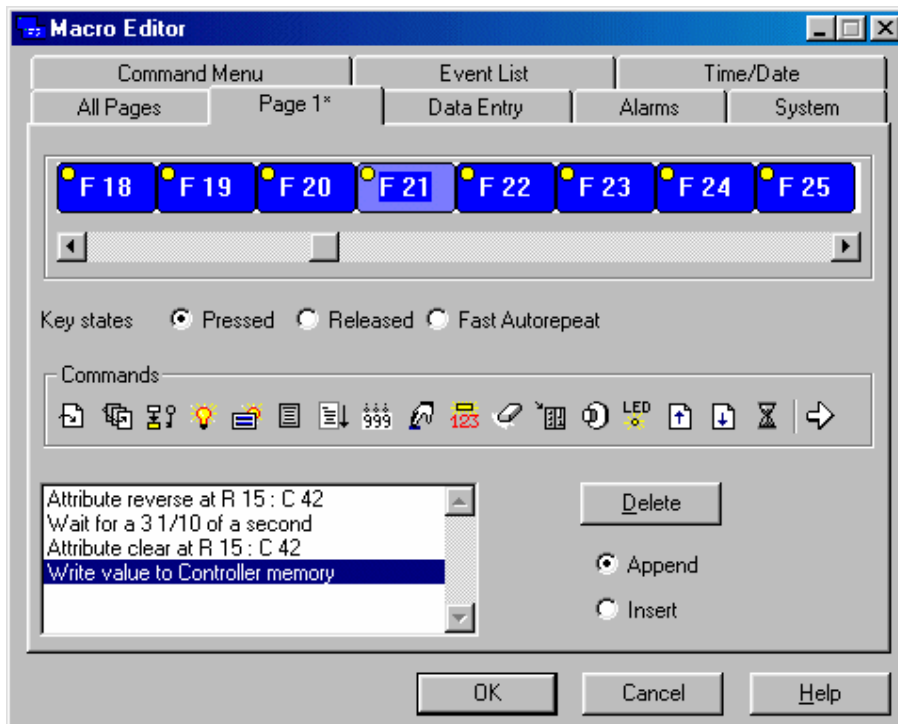

Click OK.

The result should resemble the figure below. When the panel user presses this touch cell, the value 25 will be written to the controller.



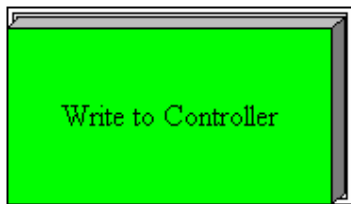

#### 4.4.89 Panel Key Button

#### 4.4.90 Panel Key Button

Panel keys represent all of the function keys, numeric keys, and arrow keys, as well as the help key, the clear key, the Enter key, the +/- key, and the decimal point key.

To insert a panel key touch cell, click on the Panel Key Button icon from the toolbar or select Insert - Touch Cells - Panel Key, then use the cursor to define the area in which the touch cell is to be placed. The Panel Key Button Properties dialog box will appear where panel key button touch cells may be configured.

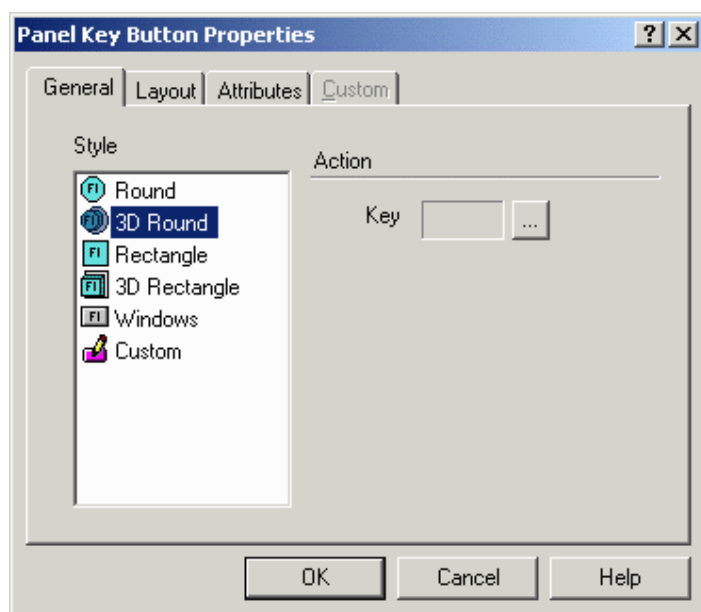

There are four tabs in the Panel Key Button Properties dialog box. They are: General, Layout, Attributes and Custom.

The General tab lets you select the style of panel button and the panel key that is to be represented.

The Layout tab lets you select the colors, font, languages, etc., to be used.

The Attributes tab lets you indicate the attributes to be associated with the panel key button.

The Custom tab is only selectable when a Custom style button is selected on the General tab. It enables you to create a custom button.

A panel key touch cell example is provided.

## 4.4.91 General

### 4.4.92 General

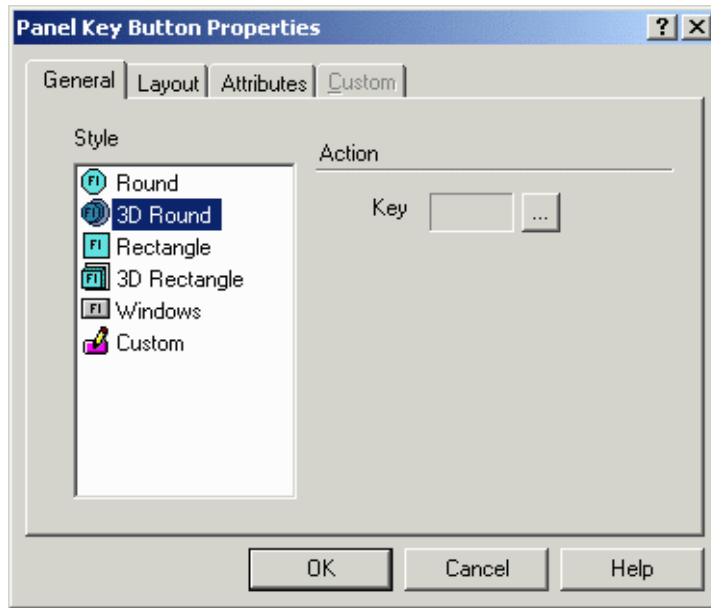

The General tab of the Panel Key Button Properties dialog box lets you select the style of panel button and the panel key that is to be represented.

### 4.4.93 Style

Within the General index tab, you can specify the appearance of the touch cell by making a selection from the Style list. Selections include round and rectangular buttons, whether flat or 3D. It is also possible to insert a Windows button (a touch cell with a look similar to the standard buttons you find in a typical Windows™ application) or to create and insert a Custom button. Selecting the Custom style activates the Custom tab.

### 4.4.94 Action

The panel key that the touch cell is to represent is indicated in the Key box under Action. To select a panel key, click on the "..." button to bring up the Change/View Panel Key Assignment dialog box.

### 4.4.95 Layout

Note: This page is used to show the Layout tab for all the Touch Cells.

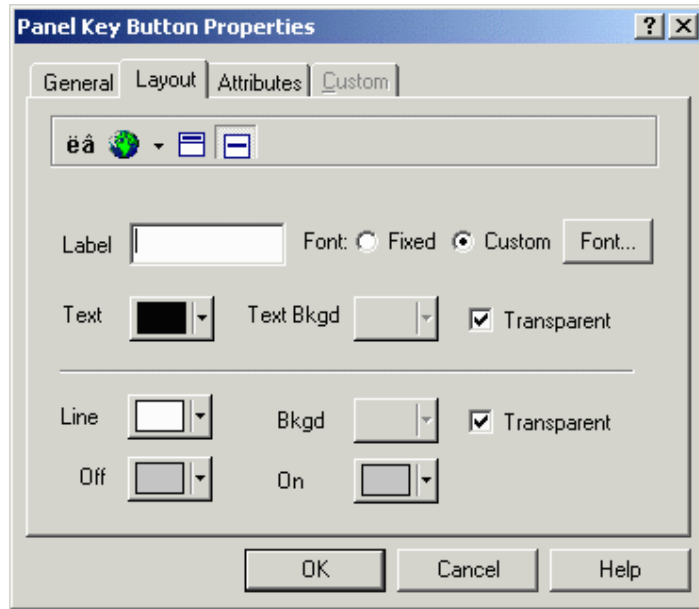

The Layout tab lets you select the colors, font, languages, etc., to be used.

The upper Toolbar portion of the box contains a Special Characters icon, a Languages icon, and label placement buttons.

Clicking on the Special Characters icon brings up the Special Characters dialog box that can be used to enter a special character into the touch cell label.

It is possible to integrate multiple languages within the same touch cell. Clicking on the Languages button brings up the Languages dialog box that lets you choose the language in which you wish to work.

The label placement icons lets you place the label either above the touch cell or centered on the touch cell.

Note: Fixed font text may only be placed above a touch cell.

The top portion of the Layout box includes commands to create and customize a label on the touch cell. For instance, rather than displaying the label F1, a panel key could read Pressure. A toolbar includes icons to customize the label on the touch cell by inserting a special character or by selecting a particular language, and label placement.

The Label box lets you specify the text that is placed either on or on top of the touch cell.

Note: The label must be entered after the key has been selected under the General tab, otherwise the default key label will override any label entered in the Label box.

Clicking on the Font button lets you select the font to be used for a particular touch cell. Once a font is selected, it will continue to be used for all touch cells that are subsequently created.

Note: This font is not a global font and may be changed at any time without affecting any of the previously created touch cells. It is possible to use different fonts on all of the touch cells in a single project file.

Text indicates the color of the touch cell text. Text Bkgd indicates the background color of the touch cell text. This color will only be seen when the Transparent checkbox is not marked, otherwise the background of the touch cell text will appear either in On or in Off color for centered text and in the Background color if the text is on top.

The bottom portion of the Layout box lets you choose the colors to be displayed on the touch cell.

Line color is the color of the lines in the touch cell. Background color is the color of the touch cell background. The touch cell background is a part of the rectangle around the circular or elliptical touch cell not covered by the cell. Rectangular touch cells have no background if the touch cell text is centered, but if it is positioned on top, a strip of background appears above the cell.

On shows the color that the touch cell will be when it is pressed, while Off indicates the color that the touch cell will be when it is in the not-pressed state.

## 4.4.96 Attributes

Note: This page is used to show the Attribute tab for all the Touch Cells.

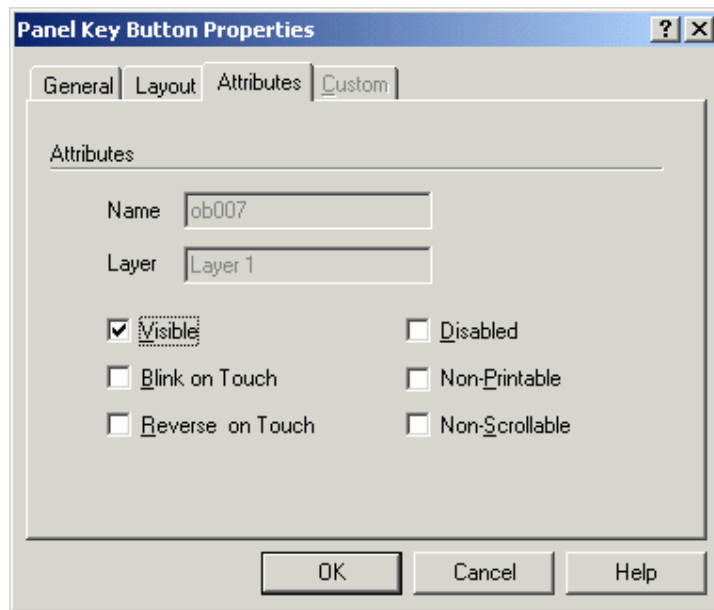

When the button is pressed you can set it to Blink, or for the colors to Reverse.

## 4.4.97 Custom

Note: This page is used to show the Custom tab for all the Touch Cells.

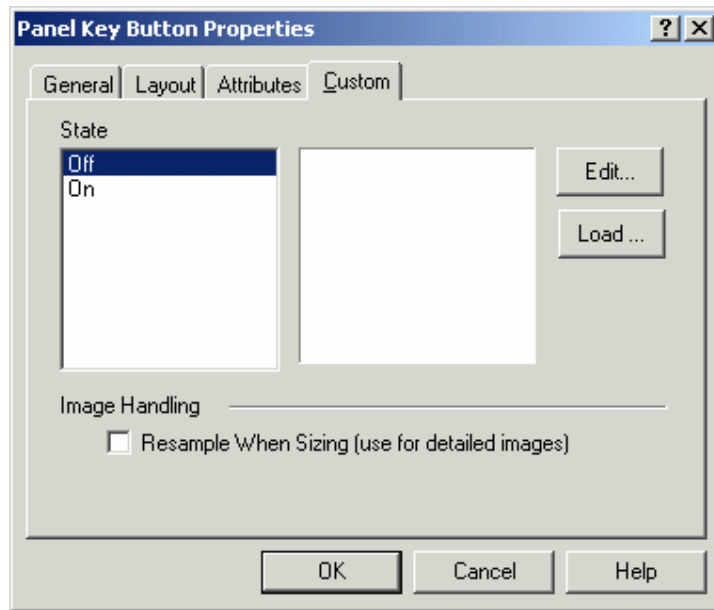

The Custom tab is only selectable when a Custom style button is selected on the General tab. It enables you to create a custom button.

Custom buttons can be created for both Off and On states. Click the Load button to import a graphic from the Graphics Library Manager.

Clicking on the Edit button brings up the Enter Bitmap Dimensions dialog box. The button width and height can be specified. Color options may also be selected, according to the selected panel's support of colors.

The Enable Indicator checkbox is available with Custom buttons. This checkbox allows you to place an indicator light on the button.

#### 4.4.98 Panel Key Button Touch Cell Example

In this example, we will create a touch cell to simulate panel key F21.

Note: It is suggested that touch cells be programmed with a reversed attribute when they are pressed so that the operator will have immediate feedback.

Select Insert - Touch Cells - Panel Key Button.

Use the cursor to outline an area on the page where the touch cell will appear.

In the Panel Key Button Properties dialog box, select Rectangle as the Style.

Under Action, click on the "..." button to identify the Key that will control the touch cell action.

Click on key F21 to select it.

Click OK.

Select the Attributes tab and select Reverse to have the touch cell reverse color when it is pressed.

Select the Layout tab and select Red as the color for On, and Yellow as the color for Off.

Click OK.

#### 4.4.99 ASCII Key Button

##### 4.4.100 ASCII Key Button

The ASCII Key Button Properties dialog box is used to create touch cells as ASCII characters. To insert an ASCII button touch cell, click the ASCII Key Button icon from the toolbar or select Insert - Touch Cells - ASCII Key Button, then use the cursor to define the area in which the touch cell is to be placed. A dialog box appears where an ASCII button touch cell may be configured.

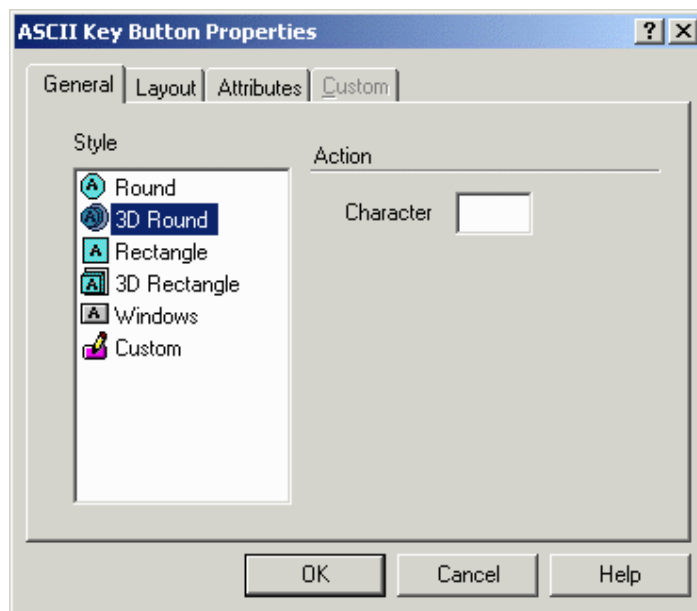

There are four tabs in the ASCII Key Button Properties dialog box. They are: General, Layout, Attributes and Custom.

The General tab allows you to select the style of button and the ASCII key that is to be represented.

The Layout tab lets you select the colors, font, languages, etc., to be used.

The Attributes tab lets you indicate the attributes to be associated with the ASCII panel key button.

The Custom tab is only selectable when a Custom style button is selected on the General tab. It lets you create a custom button.

An ASCII touch cell example is provided.

#### 4.4.101 General

#### 4.4.102 General tab

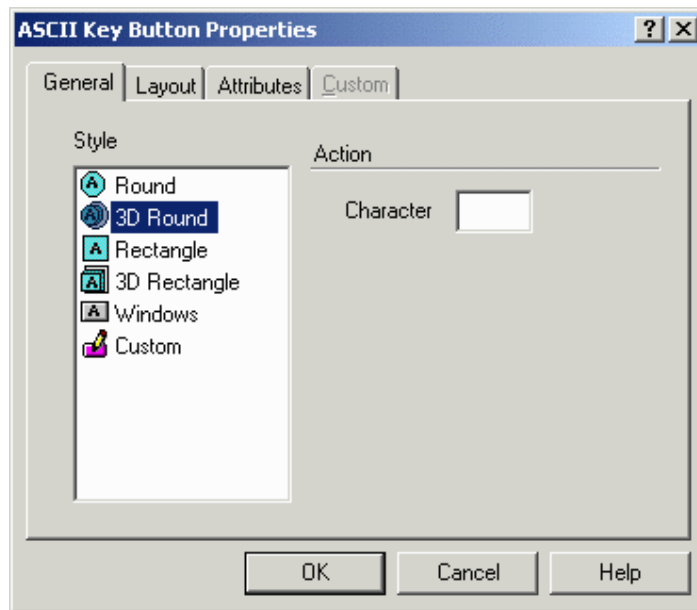

The General tab of the ASCII Key Button Properties dialog box lets you select the style of ASCII Key Button and the ASCII key character that is to represent the action.

#### 4.4.103 Style

Within the General index tab, you can specify the appearance of the touch cell by making a selection from the Style list. Selections include round and rectangular buttons, whether flat or 3D. It is also possible to insert a Windows button (a touch cell with a look similar to the standard buttons you find in a typical Windows™ application) or to create and insert a Custom button. Selecting the Custom style activates the Custom tab.

#### 4.4.104 Action

The ASCII character that is to be transmitted when the touch cell is pressed is entered in the Character box under Action.

#### 4.4.105 Layout

Note: This page is used to show the Layout tab for all the Touch Cells.

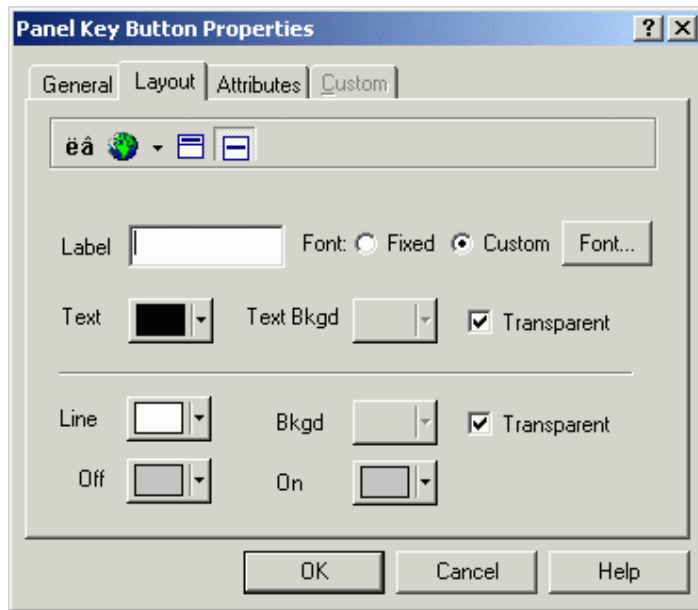

The Layout tab lets you select the colors, font, languages, etc., to be used.

The upper Toolbar portion of the box contains a Special Characters icon, a Languages icon, and label placement buttons.

Clicking on the Special Characters icon brings up the Special Characters dialog box that can be used to enter a special character into the touch cell label.

It is possible to integrate multiple languages within the same touch cell. Clicking on the Languages button brings up the Languages dialog box that lets you choose the language in which you wish to work.

The label placement icons lets you place the label either above the touch cell or centered on the touch cell.

Note: Fixed font text may only be placed above a touch cell.

The top portion of the Layout box includes commands to create and customize a label on the touch cell. For instance, rather than displaying the label F1, a panel key could read Pressure. A toolbar includes icons to customize the label on the touch cell by inserting a special character or by selecting a particular language, and label placement.

The Label box lets you specify the text that is placed either on or on top of the touch cell.

Note: The label must be entered after the key has been selected under the General tab, otherwise the default key label will override any label entered in the Label box.

Clicking on the Font button lets you select the font to be used for a particular touch cell. Once a font is selected, it will continue to be used for all touch cells that are subsequently created.

Note: This font is not a global font and may be changed at any time without affecting any of the previously created touch cells. It is possible to use different fonts on all of the touch cells in a single project file.



Text indicates the color of the touch cell text. Text Bkgd indicates the background color of the touch cell text. This color will only be seen when the Transparent checkbox is not marked, otherwise the background of the touch cell text will appear either in On or in Off color for centered text and in the Background color if the text is on top.

The bottom portion of the Layout box lets you choose the colors to be displayed on the touch cell.

Line color is the color of the lines in the touch cell. Background color is the color of the touch cell background. The touch cell background is a part of the rectangle around the circular or elliptical touch cell not covered by the cell. Rectangular touch cells have no background if the touch cell text is centered, but if it is positioned on top, a strip of background appears above the cell.

On shows the color that the touch cell will be when it is pressed, while Off indicates the color that the touch cell will be when it is in the not-pressed state.

## 4.4.106 Attributes

Note: This page is used to show the Attribute tab for all the Touch Cells.

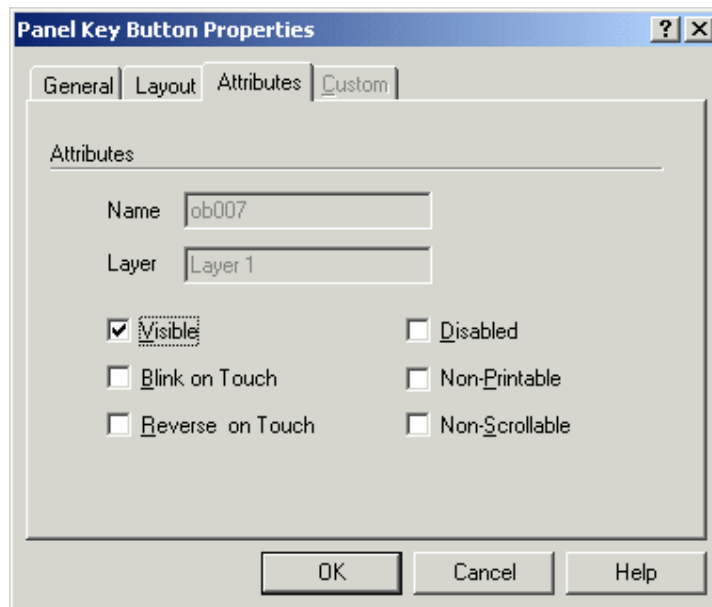

When the button is pressed you can set it to Blink, or for the colors to Reverse.

## 4.4.107 Custom

Note: This page is used to show the Custom tab for all the Touch Cells.

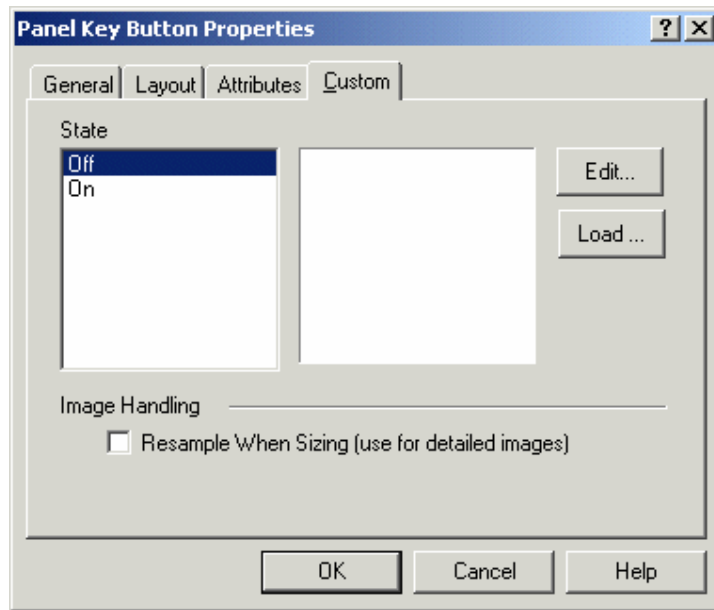

The Custom tab is only selectable when a Custom style button is selected on the General tab. It enables you to create a custom button.

Custom buttons can be created for both Off and On states. Click the Load button to import a graphic from the Graphics Library Manager.

Clicking on the Edit button brings up the Enter Bitmap Dimensions dialog box. The button width and height can be specified. Color options may also be selected, according to the selected panel's support of colors.

The Enable Indicator checkbox is available with Custom buttons. This checkbox allows you to place an indicator light on the button.

#### 4.4.108 Touch Cell Panel Key Button Example

In this example, we will configure an ASCII key as a touch cell.

Note: It is suggested that touch cells be programmed with a reversed attribute when they are pressed so that the operator will have immediate feedback.

Select Insert - Touch Cells - ASCII Key Button.

Use the cursor to outline an area on the page where the touch cell will appear.

In the ASCII Key Button Properties dialog box, select 3D Rectangle as the Style.

Under Action, enter the character that will control the touch cell action.

Select the Attributes tab and select Reverse to have the touch cell reverse color when it is pressed.

Select the Layout tab and select Red as the color for On, and Yellow as the color for Off.

In the Label box, type ASCII Key.

Adjust the Font if necessary.

Click OK.

The screen should appear similar to the figure below.

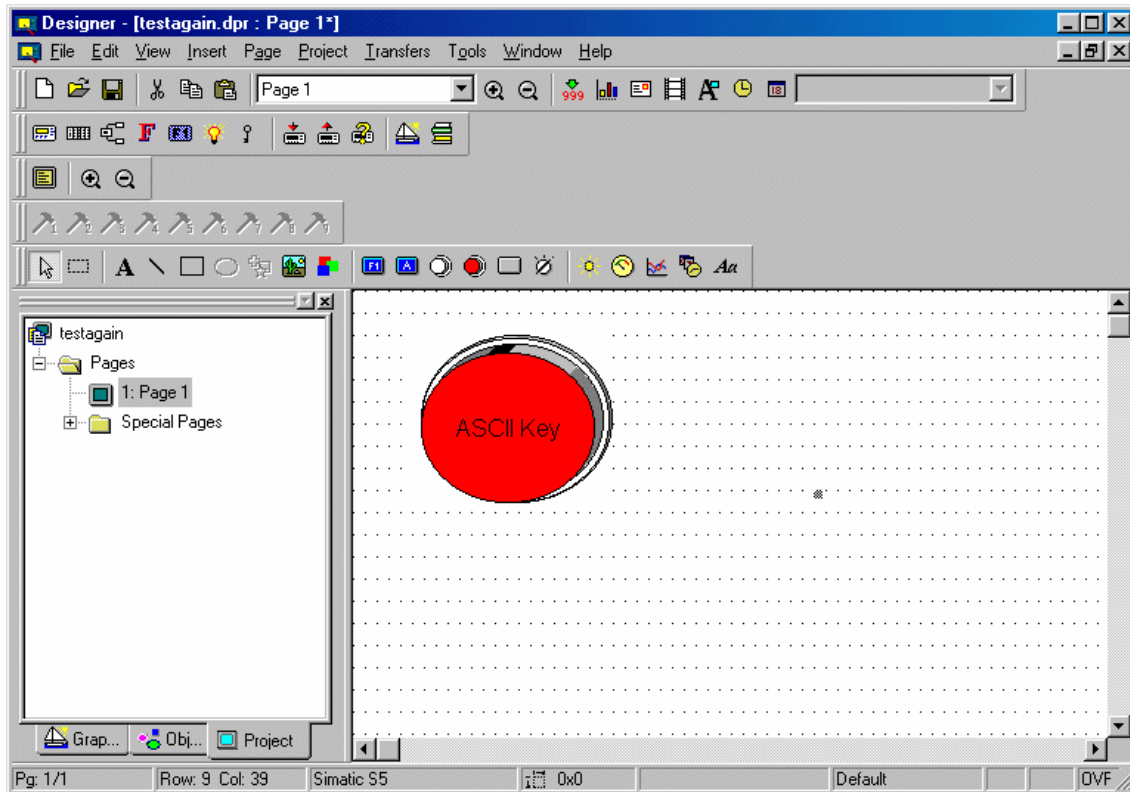

#### 4.4.109 Push Button

#### 4.4.110 Push Button

The Push Button Properties dialog box is used to create touch cells as push buttons. These push buttons mimic mechanical push buttons in that one logic value represents open contacts and another logic value represents closed contacts.

To insert a push button touch cell, click the Push Button icon on the toolbar or select Insert - Touch Cells - Push Button, then use the cursor to define the area in which the push button touch cell is to be placed. A dialog box will appear where the appearance and action of a push button touch cell may be configured.

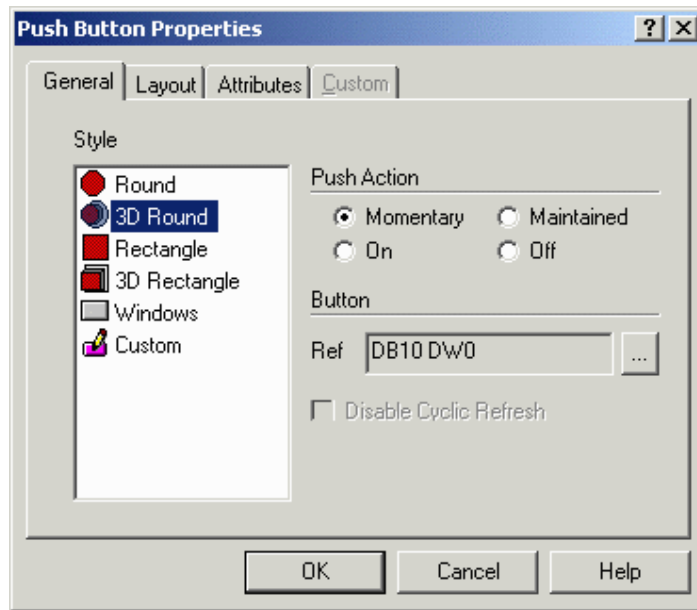

There are four tabs in the Push Button Properties dialog box. They are: General, Layout, Attributes, and Custom.

The General tab lets you select the style of push button and the action that is to be represented.

The Layout tab lets you choose the colors, font, languages, etc., to be used.

The Attributes tab lets you indicate the attributes to be associated with the push button.

The Custom tab is only selectable when a Custom style button is selected on the General tab. It lets you create a custom push button.

A push button touch cell example is provided.

#### 4.4.111 General

#### 4.4.112 General tab

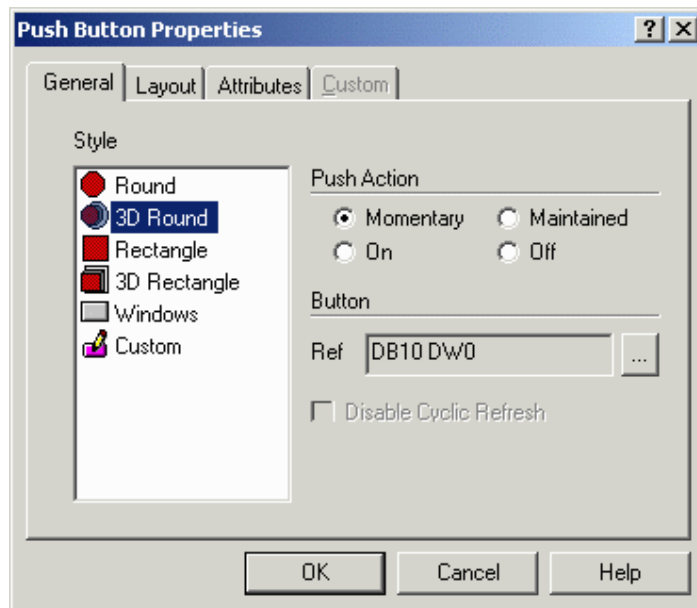

The General tab of the Push Button Properties dialog box allows you to select the style of push button, the push action, and the button reference location.

#### 4.4.113 Style

Within the General index tab, you can specify the appearance of the touch cell by making a selection from the Style list. Selections include round and rectangular buttons, whether flat or 3D. It is also possible to insert a Windows button (a touch cell with a look similar to the standard buttons you find in a typical Windows™ application) or to create and insert a Custom button. Selecting the Custom style activates the Custom tab.

#### 4.4.114 Push Action

The Push Action section allows you to select the action of the touch cell button. The different radio buttons within this group box represent the attribute that the touch cell will have whenever it is pressed.

Note: The press indicator can be used with touch cells that have graphics associated with them; however, attributes can best be seen on touch cells that are not associated with graphics.

Note: When Off is selected as the push action there will be no attribute associated with the touch cell when it is pressed. You will not be able to tell when the key has been pressed. Therefore, this option should be used only when there are graphics associated with a touch cell.

#### 4.4.115 Button

The memory location that the push button affects can be set up in the Button section. The Ref entry box shows the currently selected memory location. Clicking on the "." button brings up the Data Field Properties dialog box, which lets you select the exact memory location to be written to. You also have the option to disable the cyclic refresh.

#### 4.4.116 Layout

Note: This page is used to show the Layout tab for all the Touch Cells.

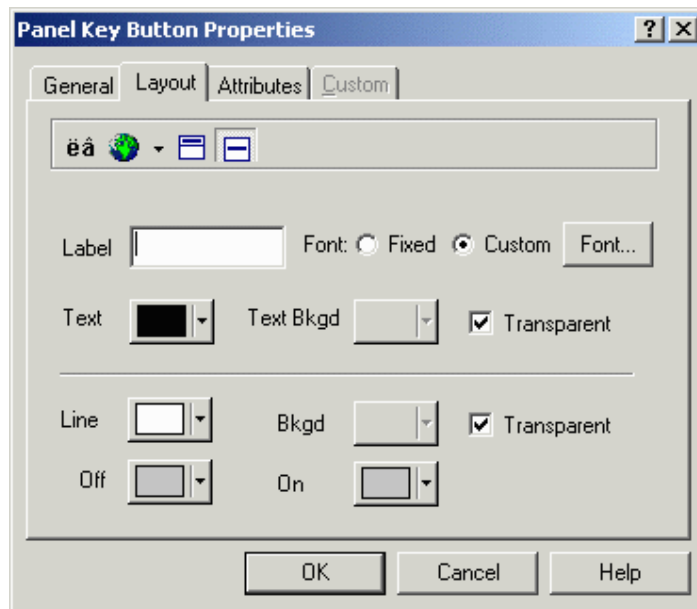

The Layout tab lets you select the colors, font, languages, etc., to be used.

The upper Toolbar portion of the box contains a Special Characters icon, a Languages icon, and label placement buttons.

Clicking on the Special Characters icon brings up the Special Characters dialog box that can be used to enter a special character into the touch cell label.

It is possible to integrate multiple languages within the same touch cell. Clicking on the Languages button brings up the Languages dialog box that lets you choose the language in which you wish to work.

The label placement icons lets you place the label either above the touch cell or centered on the touch cell.

Note: Fixed font text may only be placed above a touch cell.

The top portion of the Layout box includes commands to create and customize a label on the touch cell. For instance, rather than displaying the label F1, a panel key could read Pressure. A toolbar includes icons to customize the label on the touch cell by inserting a special character or by selecting a particular language, and label placement.

The Label box lets you specify the text that is placed either on or on top of the touch cell.

Note: The label must be entered after the key has been selected under the General tab, otherwise the default key label will override any label entered in the Label box.

Clicking on the Font button lets you select the font to be used for a particular touch cell. Once a font is selected, it will continue to be used for all touch cells that are subsequently created.

Note: This font is not a global font and may be changed at any time without affecting any of the previously created touch cells. It is possible to use different fonts on all of the touch cells in a single project file.

Text indicates the color of the touch cell text. Text Bkgd indicates the background color of the touch cell text. This color will only be seen when the Transparent checkbox is not marked, otherwise the background of the touch cell text will appear either in On or in Off color for centered text and in the Background color if the text is on top.

The bottom portion of the Layout box lets you choose the colors to be displayed on the touch cell.

Line color is the color of the lines in the touch cell. Background color is the color of the touch cell background. The touch cell background is a part of the rectangle around the circular or elliptical touch cell not covered by the cell. Rectangular touch cells have no background if the touch cell text is centered, but if it is positioned on top, a strip of background appears above the cell.

On shows the color that the touch cell will be when it is pressed, while Off indicates the color that the touch cell will be when it is in the not-pressed state.

#### 4.4.117 Attributes

Note: This page is used to show the Attribute tab for all the Touch Cells.

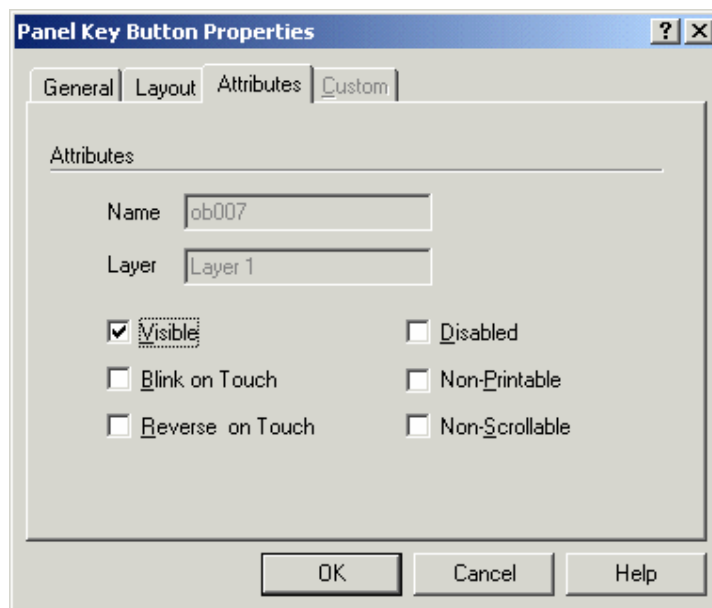

When the button is pressed you can set it to Blink, or for the colors to Reverse.

#### 4.4.118 Custom

Note: This page is used to show the Custom tab for all the Touch Cells.

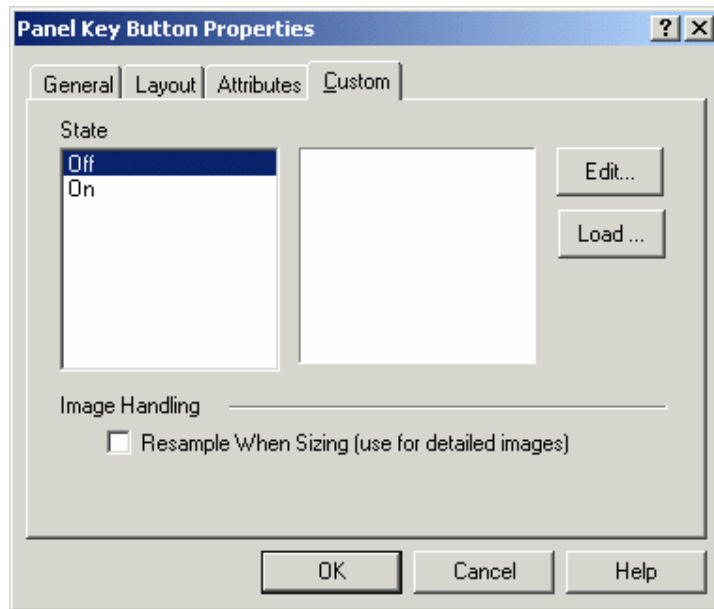

The Custom tab is only selectable when a Custom style button is selected on the General tab. It enables you to create a custom button.

Custom buttons can be created for both Off and On states. Click the Load button to import a graphic from the Graphics Library Manager.

Clicking on the Edit button brings up the Enter Bitmap Dimensions dialog box. The button width and height can be specified. Color options may also be selected, according to the selected panel's support of colors.

The Enable Indicator checkbox is available with Custom buttons. This checkbox allows you to place an indicator light on the button.

#### 4.4.119 Push Button Touch Cell Example

In this example, we will configure a push button touch cell.

Note: It is suggested that touch cells be programmed with a reversed attribute when they are pressed so that the operator will have immediate feedback.

Select Insert - Touch Cells - Push Button.

Use the cursor to outline an area on the page where the touch cell will appear.

In the Push Button Properties dialog box, select 3D Round as the Style.



Under Push Action, select the desired push button action.

Click on the "... " button to identify the controller reference location that will be mapped to the touch cell.

Select the Attributes tab and select Reverse to have the touch cell reverse color when it is pressed.

Select the Layout tab and select Red as the color for On, and Yellow as the color for Off.

In the Label box, type Push Button.

Adjust the Font if necessary.

Click OK.

The screen should appear similar to the figure below.

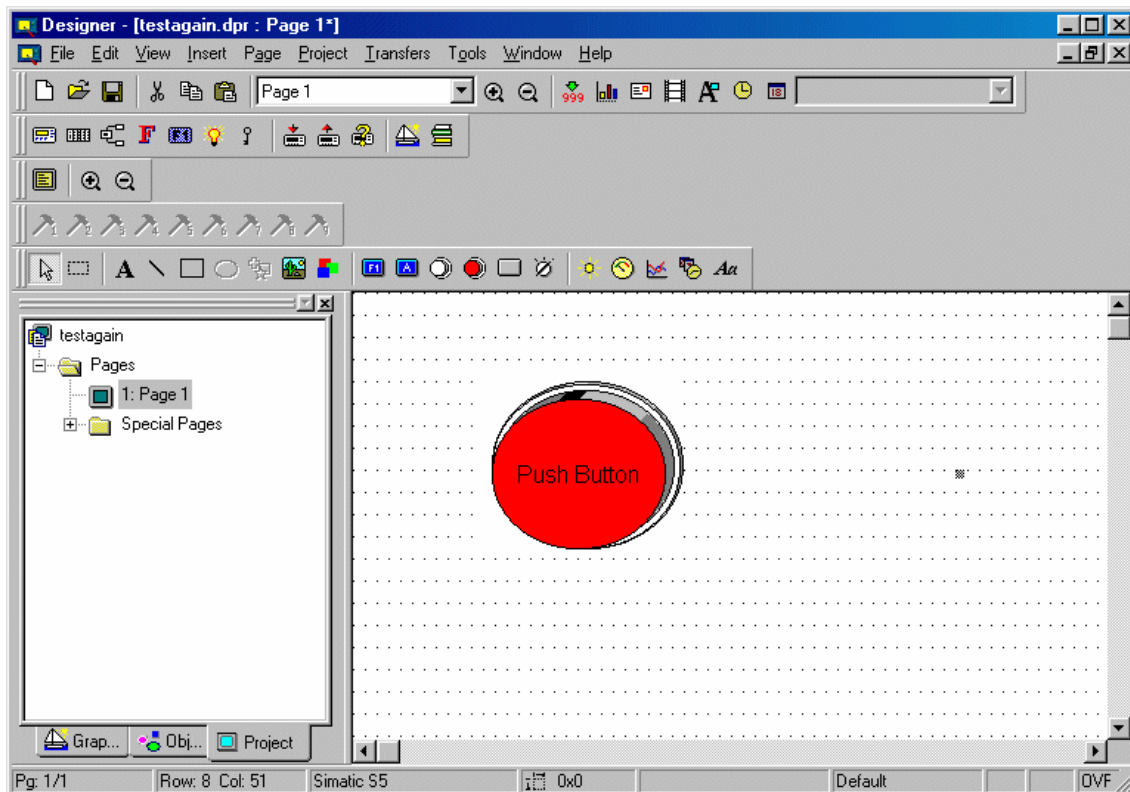

#### 4.4.120 Illuminated Push Button

#### 4.4.121 Illuminated Push Button

The Illuminated Push Button Properties dialog box is used to create a touch cell as an illuminated push button. The only difference between an illuminated push button and a push button is that the face of the illuminated push button can reflect the status of a bit in the PLC.

To insert an illuminated push button touch cell, click the Illuminated Push Button icon from the toolbar or select Insert - Touch Cells - Illuminated Push Button, then use the cursor to define the area in which the illuminated push button touch cell is to be placed. The Illuminated Push Button Properties dialog box will appear where the appearance and action of an illuminated push button touch cell may be configured.

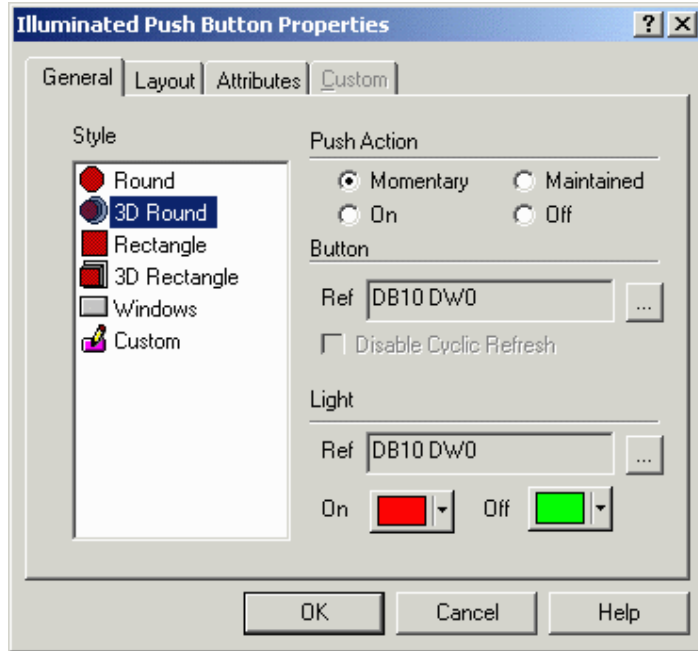

There are four tabs in the Illuminated Push Button Properties dialog box. They are: General, Layout, Attributes and Custom.

The General tab allows you to select the style of push button, the action that is to be represented, and the memory location that has its status shown on the face of the button.

The Layout tab lets you select the colors, font, languages, etc., to be used.

The Attributes tab lets you indicate the attributes to be associated with the illuminated push button.

The Custom tab is only selectable when a Custom style button is selected on the General tab. It enables you to create a custom button.

An illuminated push button touch cell example is provided.

## 4.4.122 General

## 4.4.123 General

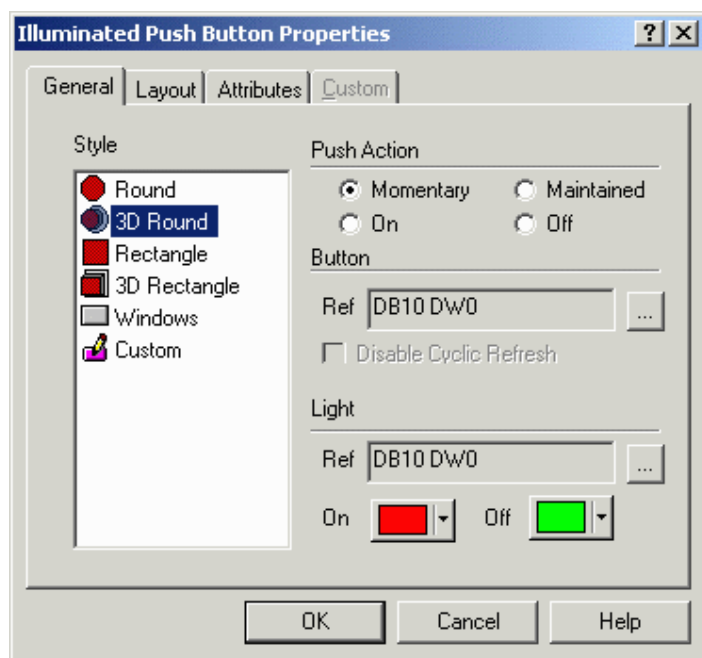

The General tab allows you to select the style of push button, the action that is to be represented, and the memory location that has its status shown on the face of the button.

## 4.4.124 Style

Within the General index tab, you can specify the appearance of the touch cell by making a selection from the Style list. Selections include round and rectangular buttons, whether flat or 3D. It is also possible to insert a Windows button (a touch cell with a look similar to the standard buttons you find in a typical Windows™ application) or to create and insert a Custom button. Selecting the Custom style activates the Custom tab.

## 4.4.125 Push Action

The Push Action section allows you to select the action of the touch cell button. The different radio buttons within this group box represent the attribute that the touch cell will have whenever it is pressed.

Note: The press indicator can be used with touch cells that have graphics associated with them; however, attributes can best be seen on touch cells that are not associated with graphics.

Note: When Off is selected as the push action there will be no attribute associated with the touch cell when it is pressed. You will not be able to tell when the key has been pressed.

Therefore, this option should be used only when there are graphics associated with a touch cell.

#### 4.4.126 Button

The memory location that the illuminated push button affects when it is pressed can be set up in the Button section. The Ref entry box shows the currently selected memory location. Clicking on the "..." button brings up the Data Field Properties dialog box, where you can select the exact memory location to be affected. You also have the option to disable the cyclic refresh.

#### 4.4.127 Light

The Light section enables you to set the colors for On and Off stages of the illuminated push button. The Ref entry box shows the memory location that is reflected by the Light. Clicking on the "..." button brings up the Data Field Properties dialog box, which allows you to select the exact memory location to be reflected.

#### 4.4.128 Layout

Note: This page is used to show the Layout tab for all the Touch Cells.

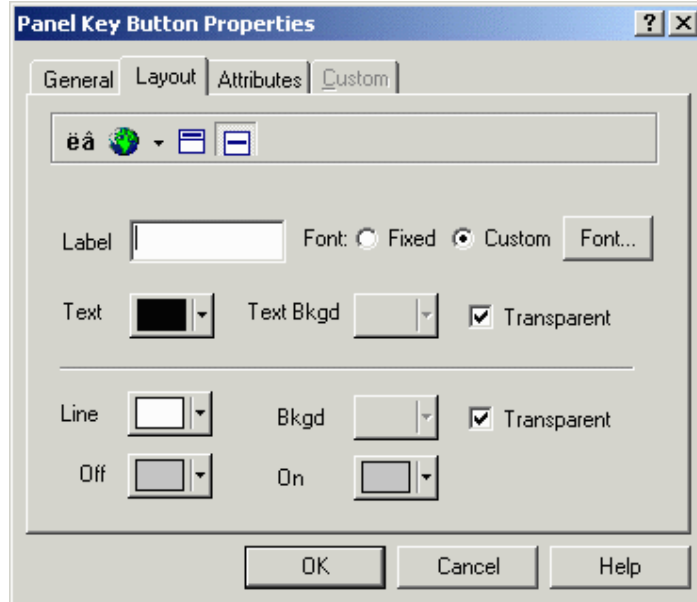

The Layout tab lets you select the colors, font, languages, etc., to be used.

The upper Toolbar portion of the box contains a Special Characters icon, a Languages icon, and label placement buttons.

Clicking on the Special Characters icon brings up the Special Characters dialog box that can be used to enter a special character into the touch cell label.

It is possible to integrate multiple languages within the same touch cell. Clicking on the Languages button brings up the Languages dialog box that lets you choose the language in which you wish to work.

The label placement icons lets you place the label either above the touch cell or centered on the touch cell.

Note: Fixed font text may only be placed above a touch cell.

The top portion of the Layout box includes commands to create and customize a label on the touch cell. For instance, rather than displaying the label F1, a panel key could read Pressure. A toolbar includes icons to customize the label on the touch cell by inserting a special character or by selecting a particular language, and label placement.

The Label box lets you specify the text that is placed either on or on top of the touch cell.

Note: The label must be entered after the key has been selected under the General tab, otherwise the default key label will override any label entered in the Label box.

Clicking on the Font button lets you select the font to be used for a particular touch cell. Once a font is selected, it will continue to be used for all touch cells that are subsequently created.

Note: This font is not a global font and may be changed at any time without affecting any of the previously created touch cells. It is possible to use different fonts on all of the touch cells in a single project file.

Text indicates the color of the touch cell text. Text Bkgd indicates the background color of the touch cell text. This color will only be seen when the Transparent checkbox is not marked, otherwise the background of the touch cell text will appear either in On or in Off color for centered text and in the Background color if the text is on top.

The bottom portion of the Layout box lets you choose the colors to be displayed on the touch cell.

Line color is the color of the lines in the touch cell. Background color is the color of the touch cell background. The touch cell background is a part of the rectangle around the circular or elliptical touch cell not covered by the cell. Rectangular touch cells have no background if the touch cell text is centered, but if it is positioned on top, a strip of background appears above the cell.

On shows the color that the touch cell will be when it is pressed, while Off indicates the color that the touch cell will be when it is in the not-pressed state.

#### **4.4.129      Attributes**

Note: This page is used to show the Attribute tab for all the Touch Cells.

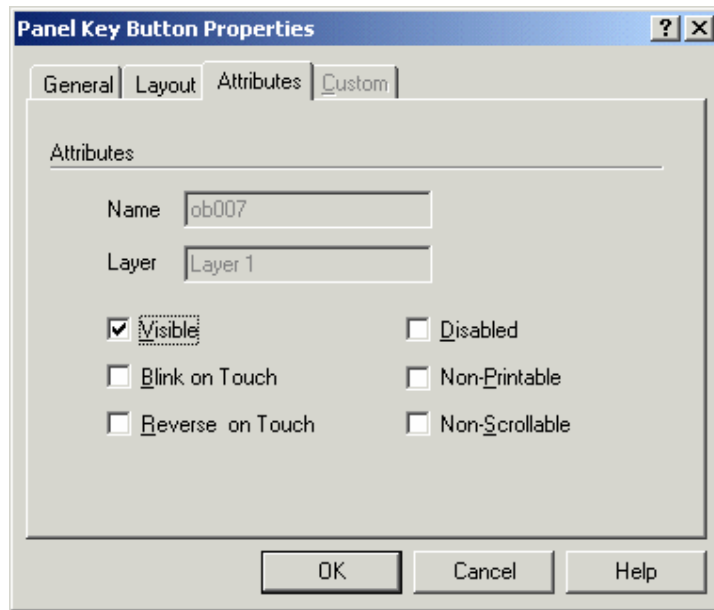

When the button is pressed you can set it to Blink, or for the colors to Reverse.

#### 4.4.130 Custom

Note: This page is used to show the Custom tab for all the Touch Cells.

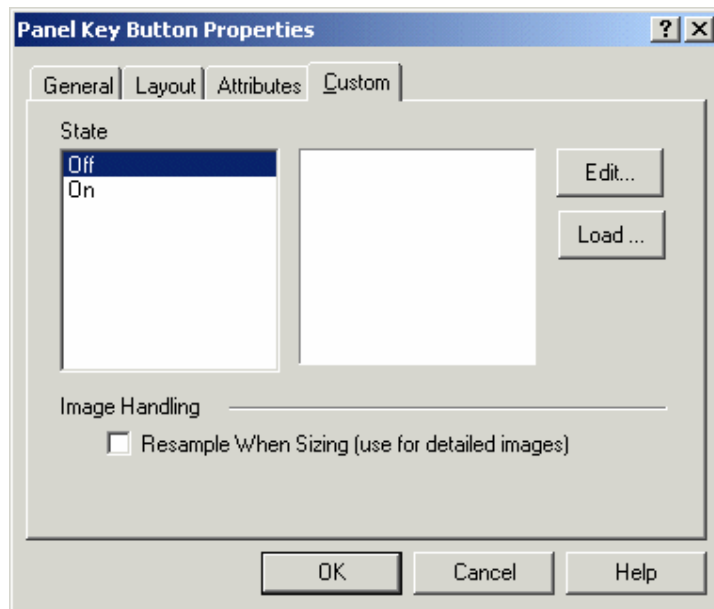

The Custom tab is only selectable when a Custom style button is selected on the General tab. It enables you to create a custom button.

Custom buttons can be created for both Off and On states. Click the Load button to import a graphic from the Graphics Library Manager.

Clicking on the Edit button brings up the Enter Bitmap Dimensions dialog box. The button width and height can be specified. Color options may also be selected, according to the selected panel's support of colors.

The Enable Indicator checkbox is available with Custom buttons. This checkbox allows you to place an indicator light on the button.

#### **4.4.131 Illuminated Push Button Example**

In this example, we will configure a push button touch cell

Note: It is suggested that touch cells be programmed with a reversed attribute when they are pressed so that the operator will have immediate feedback.

Select Insert - Touch Cells - Illuminated Push Button.

Use the cursor to outline an area on the page where the touch cell will appear.

In the Illuminated Push Button Properties dialog box, select 3D Round as the Style.

Under Push Action, click on the "... " button to identify the controller reference location that will be mapped to the touch cell push action.

Under Light, click on the "... " button to identify the controller reference location that will be mapped to the touch cell light.

Select Red as the color for On, and Green as the color for Off.

Select the Attributes tab and select Reverse to have the touch cell reverse color when it is pressed.

Select the Layout tab and in the Label box, type Illuminated Push Button.

Adjust the Font if necessary.

Click OK.

The screen should appear similar to the figure below.

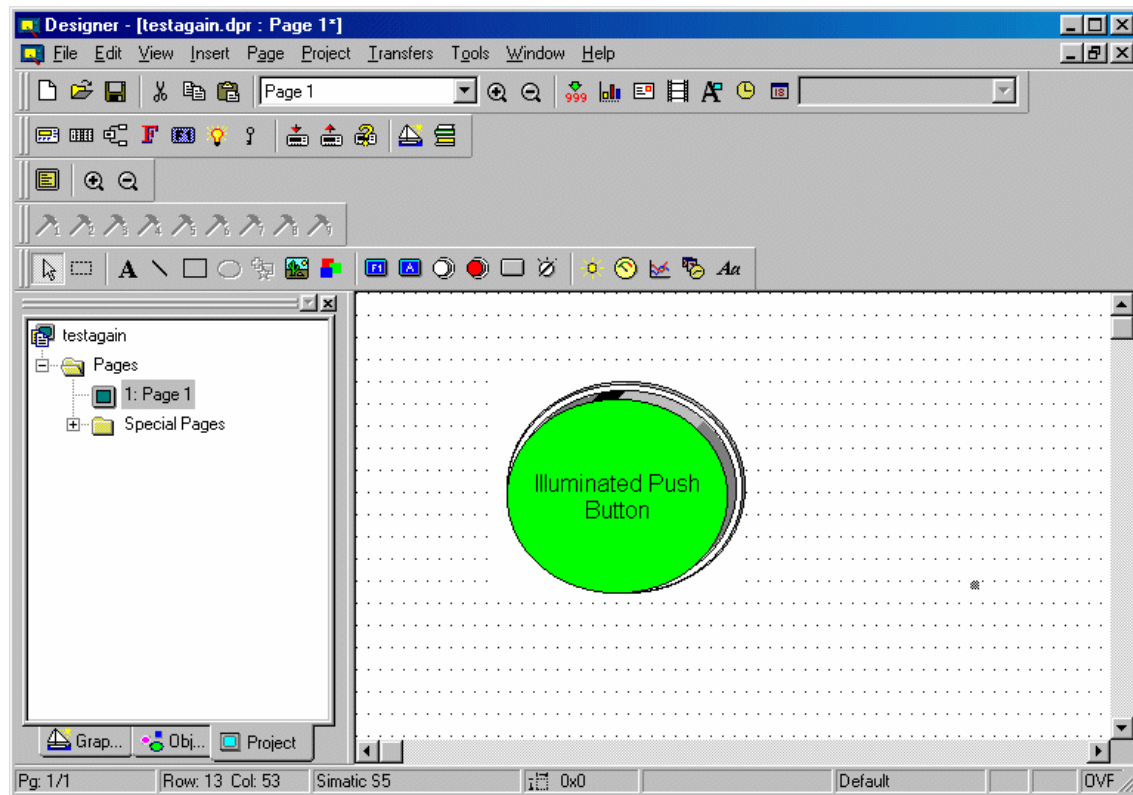

#### 4.4.132 Selector Switch

#### 4.4.133 Selector Switch

The Selector Switch Properties dialog box is used to create a selector switch of N states (where N represents an integer from 2 through 4).

To insert a selector switch touch cell, click the Selector Switch icon from the toolbar or select Insert - Touch Cells - Selector Switch, then use the cursor to define the area in which the touch cell is to be placed. A dialog box will appear where the appearance and action of a selector switch touch cell may be configured.



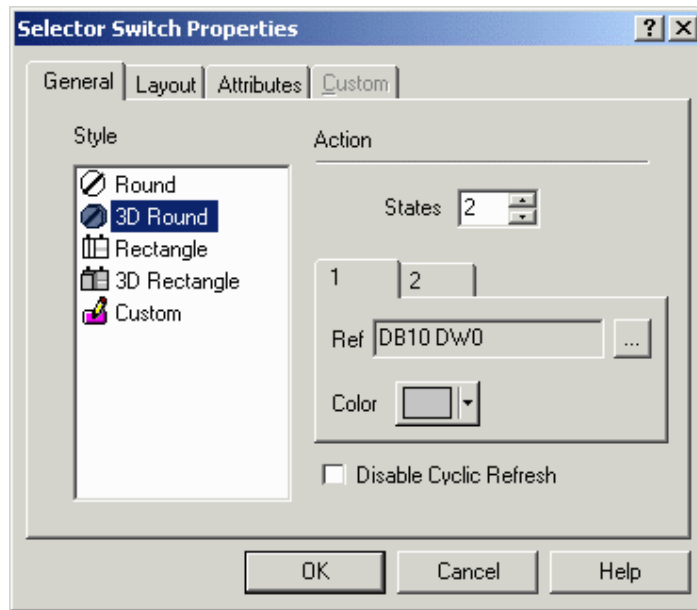

There are three tabs in the Selector Switch Properties dialog box. They are: General, Layout, and Custom.

The General tab allows you to select the style of selector switch, the number of states and the memory location in the controller that is affected by each state.

The Layout tab lets you select the colors, font, languages, etc., to be used.

The Custom tab is only selectable when a Custom style button is selected on the General tab. It lets you create a custom button.

A selector switch touch cell example is provided.

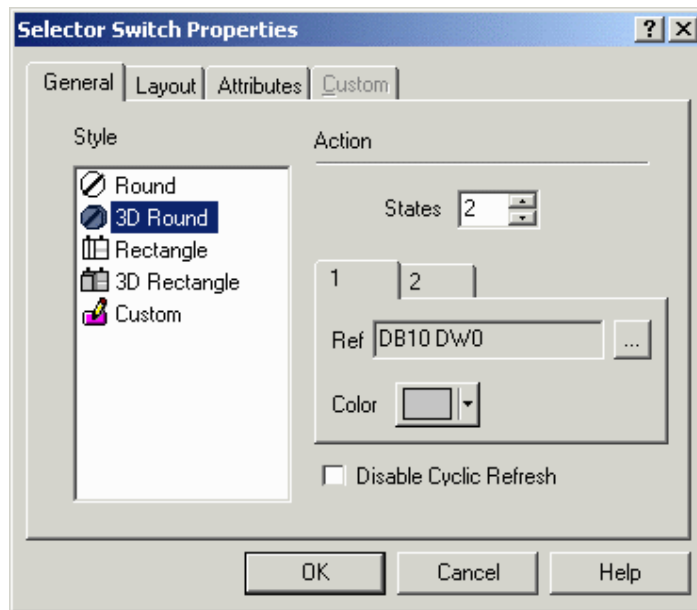
**4.4.134 General****4.4.135 General**

The General tab of the Selector Switch dialog box allows you to select the Style of selector switch and the Action.

**4.4.136 Style**

Within the General index tab, you can specify the appearance of the touch cell by making a selection from the Style list. Selections include round and rectangular buttons, both flat and 3D. It is also possible to create and insert a Custom button. Selecting the Custom style activates the Custom tab.

**4.4.137 Action**

In the Action section you can set the number of states. The minimum number of states is two (2), and the maximum number of states is four (4). You can also configure which memory location in the controller is affected by each state of the selector switch, as well as the color scheme for each state.

The Ref entry box shows the currently selected memory location. Clicking on the "..." button brings up the Data Field Properties dialog box, which allows you to select the exact memory location to be written to.

You also have the option to disable the cyclic refresh.

#### 4.4.138      **Layout**

The Layout tab of the Selector Switch Properties dialog box lets you select the colors, font, languages, etc., to be used. Select the tab with the number of the state to be configured. The upper Toolbar portion of the box contains a Special Characters icon, a Languages icon, and label placement buttons.

Clicking on the Special Characters icon brings up the Special Characters dialog box that can be used to enter a special character into the touch cell label.

It is possible to integrate multiple languages within the same touch cell. Clicking on the Languages button brings up the Languages dialog box that lets you choose the language in which you wish to work.

The label placement icons lets you place the label either above the touch cell or centered on the touch cell.

Note: Fixed font text may only be placed above a touch cell.

The top portion of the Layout box includes commands to create and customize a label on the touch cell. For instance, rather than displaying the label F1, a panel key could read Pressure. A toolbar includes icons to customize the label on the touch cell by inserting a special character or by selecting a particular language, and label placement. The Label box lets you specify the text that is placed either on or on top of the touch cell.

Note: The label must be entered after the key has been selected under the General tab, otherwise the default key label will override any label entered in the Label box. Clicking on the Font button lets you select the font to be used for a particular touch cell. Once a font is selected, it will continue to be used for all touch cells that are subsequently created.

Note: This font is not a global font and may be changed at any time without affecting any of the previously created touch cells. It is possible to use different fonts on all of the touch cells in a single project file.

Text indicates the color of the touch cell text. Text Bkgd indicates the background color of the touch cell text. This color will only be seen when the Transparent checkbox is not marked, otherwise the background of the touch cell text will appear either in On or in Off color for centered text and in the Background color if the text is on top.

The bottom portion of the Layout box lets you choose the colors to be displayed on the touch cell.

Line color is the color of the lines in the touch cell. Background color is the color of the touch cell background. The touch cell background is a part of the rectangle around the circular or elliptical touch cell not covered by the cell. Rectangular touch cells have no background if the touch cell text is centered, but if it is positioned on top, a strip of background appears above the cell.

On shows the color that the touch cell will be when it is pressed, while Off indicates the color that the touch cell will be when it is in the not-pressed state.

#### 4.4.139      **Custom**

The Custom tab is only selectable when the Custom style is selected on the General tab. It enables you to create a custom selector switch.

Custom selector switches can be created for multiple states, defined under the Action section of the General tab. Click the Load button to import a graphic from the Graphics Library Manager.

Clicking on the Edit button brings up the Enter Bitmap Dimensions dialog box. The width and height can be specified. Color options may also be selected, according to the selected panel's support of colors.

#### **4.4.140 Selector Switch Touch Cell Example**

In this example, we will configure a selector switch with two (2) states.

Select Insert - Touch Cells - Selector Switch.

Use the cursor to outline an area on the page where the touch cell will appear.

In the Selector Switch Properties dialog box, select 3D Round as the Style.

Under Action, set the number of states to 3.

For state 1, click on the "..." button to identify the controller reference location that will be mapped to state 1. Set the color for the first state to Red.

Click on the tab for state 2, and click on the "..." button to identify the controller reference location that will be mapped to the state 2. Set the color for the second state to Yellow.

Click on the tab for state 3, and click on the "..." button to identify the controller reference location that will be mapped to the state 3. Set the color for the third state to Green.

Select the Layout tab and in the Label box for state 1, type State 1.

Click the tab in the Label box for state 2 and type State 2.

Click the tab in the Label box for state 3 and type State 3.

Adjust the Font if necessary.

Click OK.

The screen should appear similar to the figure below.

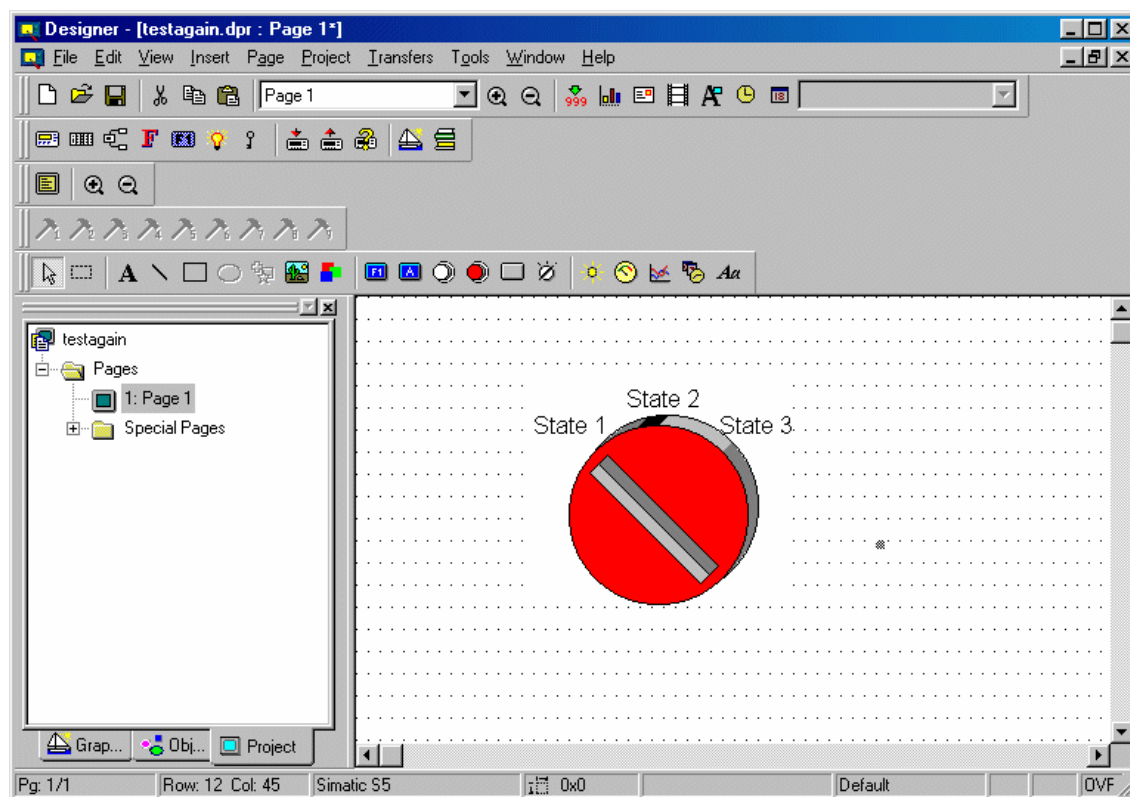

#### 4.4.141 Indicator Light

#### 4.4.142 Indicator Light

The Indicator Light Properties dialog box is used to create a touch cell as an indicator light.

To insert an indicator light touch cell, click the Indicator Light icon from the toolbar or select Insert - Touch Cells - Indicator Light, then use the cursor to define the area in which the touch cell is to be placed. A dialog box will appear where the appearance and action of an indicator light touch cell may be configured.

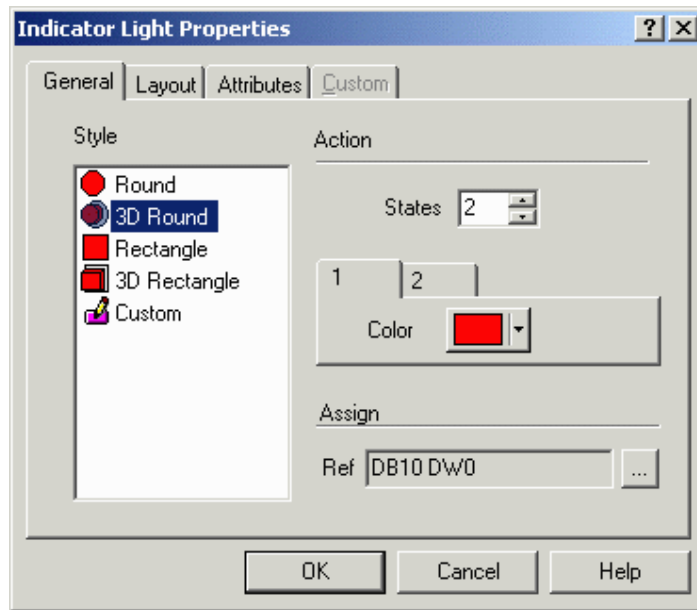

There are three tabs in the Indicator Light Properties dialog box. They are: General, Layout, and Custom.

The General tab allows you to select the style of indicator light, the number of states and the memory location in the controller that the indicator light is to reflect.

The Layout tab lets you select the colors, font, languages, etc., to be used.

The Custom tab is only selectable when a Custom style button is selected on the General tab. It enables you to create a custom button.

An indicator light touch cell example is provided.

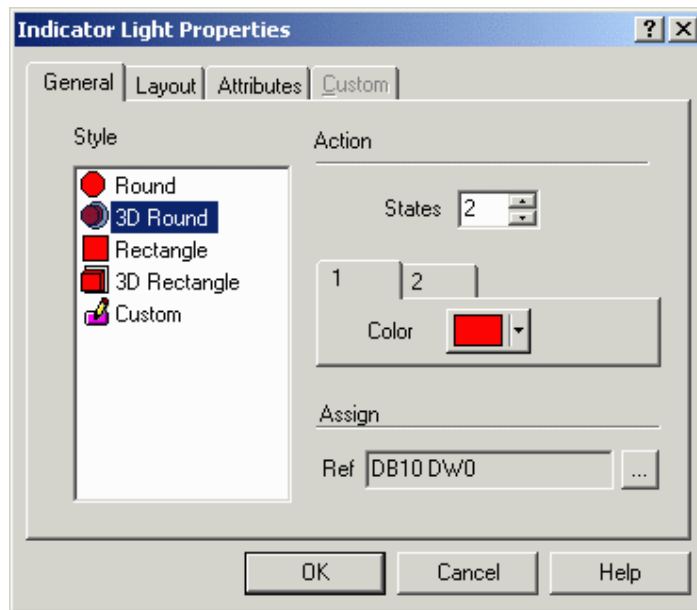
**4.4.143 General****4.4.144 General**

The General tab of the Indicator Light Properties dialog box lets you select the style of panel button, the number of states, and the memory location for each state.

**4.4.145 Style**

Within the General index tab, you can specify the appearance of the touch cell by making a selection from the Style list. Selections include round and rectangular buttons, whether flat or 3D. It is also possible to insert a Custom button. Selecting the Custom style activates the Custom tab.

**4.4.146 Action**

In the Action section you can set the number of states. The minimum number of states is two (2), and the maximum number of states is four (4). You can also define the color scheme for each state. Note that the indicator light can be configured to handle up to four (4) different states. A different color can be assigned to each state in order to reflect the contents of the memory location in the controller.

**4.4.147 Assign**

You can also configure which memory location in the controller is reflected by each state of the indicator light. The Ref entry box in the Assign section shows the currently selected memory location. Clicking on the "..." button brings up the Data Field Properties dialog box, which allows you to select the exact memory location to be reflected.

#### 4.4.148      **Layout**

The Layout tab lets you select the colors, font, languages, etc., to be used. The upper Toolbar portion of the box contains a Special Characters icon, a Languages icon, and label placement buttons.

Clicking on the Special Characters icon brings up the Special Characters dialog box that can be used to enter a special character into the touch cell label.

It is possible to integrate multiple languages within the same touch cell. Clicking on the Languages button brings up the Languages dialog box that lets you choose the language in which you wish to work. The label placement icons lets you place the label either above the touch cell or centered on the touch cell.

Note: Fixed font text may only be placed above a touch cell.

The top portion of the Layout box includes commands to create and customize a label on the touch cell. For instance, rather than displaying the label F1, a panel key could read Pressure. A toolbar includes icons to customize the label on the touch cell by inserting a special character or by selecting a particular language, and label placement.

The Label box lets you specify the text that is placed either on or on top of the touch cell.

Note: The label must be entered after the key has been selected under the General tab, otherwise the default key label will override any label entered in the Label box.

Clicking on the Font button lets you select the font to be used for a particular touch cell. Once a font is selected, it will continue to be used for all touch cells that are subsequently created.

Note: This font is not a global font and may be changed at any time without affecting any of the previously created touch cells. It is possible to use different fonts on all of the touch cells in a single project file.

Text indicates the color of the touch cell text. Text Bkgd indicates the background color of the touch cell text. This color will only be seen when the Transparent checkbox is not marked, otherwise the background of the touch cell text will appear either in On or in Off color for centered text and in the Background color if the text is on top.

The bottom portion of the Layout box lets you choose the colors to be displayed on the touch cell.

Line color is the color of the lines in the touch cell. Background color is the color of the touch cell background. The touch cell background is a part of the rectangle around the circular or elliptical touch cell not covered by the cell. Rectangular touch cells have no background if the touch cell text is centered, but if it is positioned on top, a strip of background appears above the cell.



#### **4.4.149 Custom**

The Custom tab is only selectable when the Custom style is selected on the General tab. It enables you to create a custom indicator light.

Custom indicator lights can be created for multiple states, defined under the Action section of the General tab. Click the Load button to import a graphic from the Graphics Library Manager.

Clicking on the Edit button brings up the Enter Bitmap Dimensions dialog box. The width and height can be specified. Color options may also be selected, according to the selected panel's support of colors.

#### **4.4.150 Indicator Light Touch Cell Example**

In this example, we will configure a selector switch with two (2) states.

Select Insert - Touch Cells - Indicator Light.

Use the cursor to outline an area on the page where the touch cell will appear.

In the Indicator Light Properties dialog box, select 3D Round as the Style.

Under Action, set the number of states to 3.

Set the color for the first state to Red.

Click on the tab for state 2, and set the color for the second state to Yellow.

Click on the tab for state 3, and set the color for the third state to Green.

Under Assign, click on the "..." button to identify the controller reference location that will be mapped to the indicator light. Select the Layout tab and in the Label box, type Indicator Light.

Adjust the Font if necessary.

Click OK.

The screen should appear similar to the figure below.

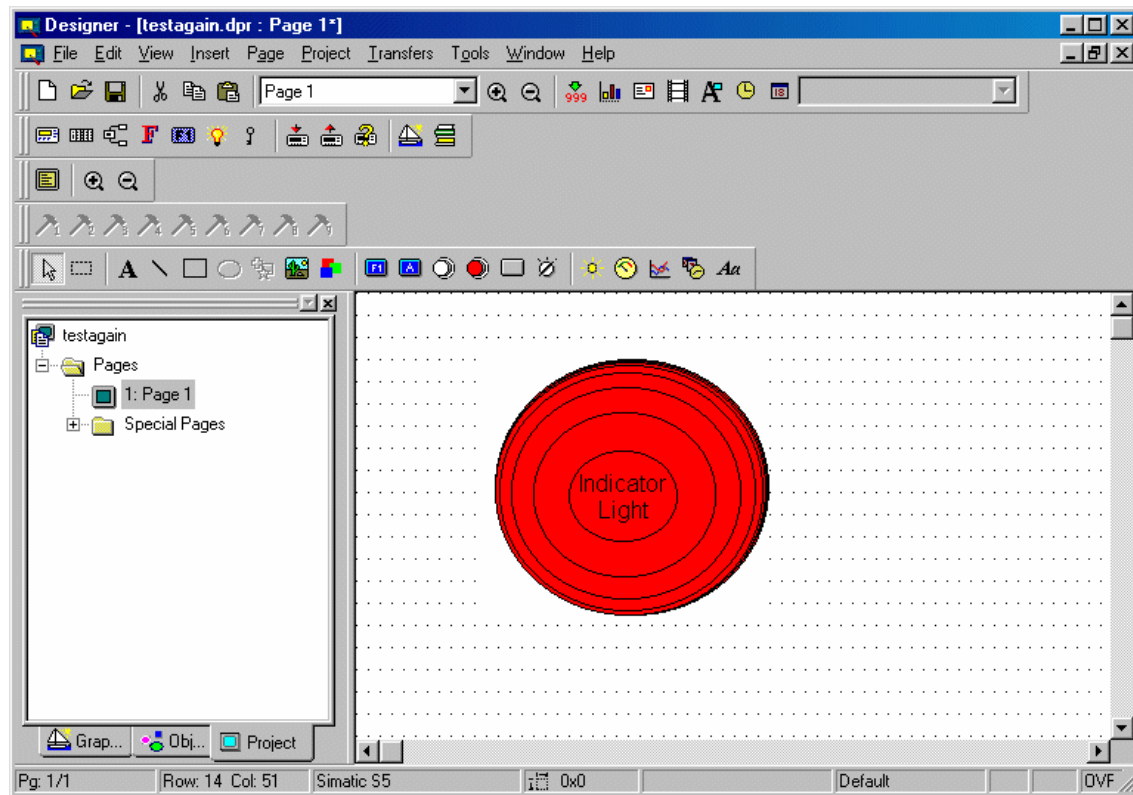

#### 4.4.151 Generic Command Button

#### 4.4.152 Generic Command Button

The Generic Command Button dialog box is used to create a touch cell as a generic command.

To insert a selector switch touch cell, click the Generic Button icon from the toolbar or select Insert - Touch Cells - Generic Command Button, then use the cursor to define the area in which the touch cell is to be placed. The Generic Button Properties dialog box will appear where the appearance and action of a generic command button touch cell may be configured.

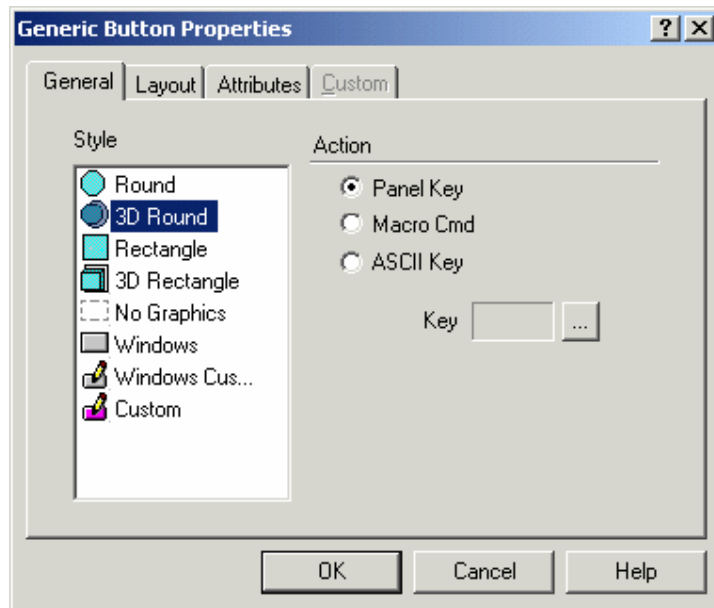

There are four tabs in the Generic Button Properties dialog box. They are: General, Layout, Attributes and Custom.

The General tab allows you to select the style of generic command button, and the action to be reflected.

The Layout tab lets you select the colors, font, languages, etc., to be used.

The Attributes tab lets you indicate the attributes to be associated with the generic push button.

The Custom tab is only selectable when a Custom or Windows Custom style button is selected on the General tab. It enables you to create a customized button.

A generic command button touch cell example is provided.

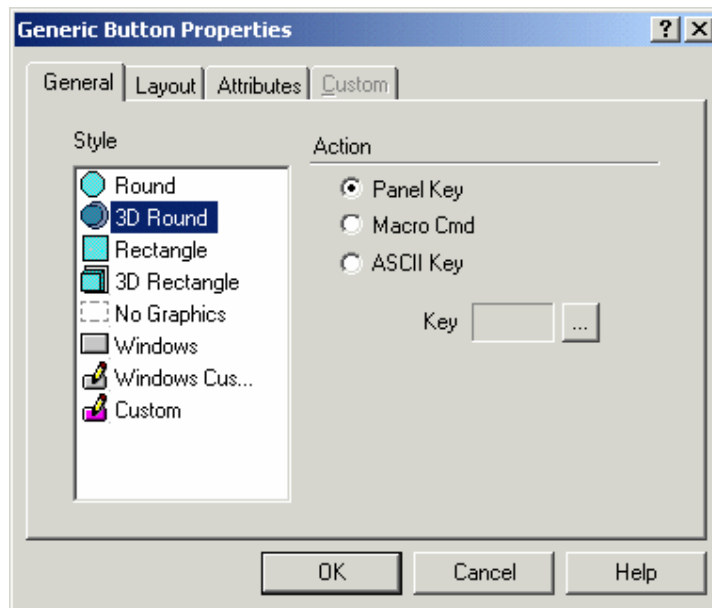
**4.4.153 General****4.4.154 General**

The General tab of the Generic Button Properties dialog box lets you select the style of button and the action that is to be represented.

**4.4.155 Style**

Within the General index tab, you can specify the appearance of the touch cell by making a selection from the Style list. Selections include flat or 3D round and rectangular buttons, no graphics, Windows and Windows Custom buttons, and Custom buttons. Selecting the Custom or Windows Custom style activates the Custom tab.

The option No Graphics can create a touch cell that is entirely invisible. For example, you may have a graphic that encompasses the entire screen of a control process in a factory. It contains images of flow control valves, motors, and blowers. You can create touch cells on the separate images and configure them to perform certain tasks. For instance, if you press the touch cell that is on the image of the motor, the motor may turn on. If you press the touch cell that is on the image of a valve, the valve may close, etc. All that will be seen on the screen is the image of the process; the touch cells will be invisible.

**4.4.156 Action**

To define the functionality of the touch cell, select one of the three radio buttons under the Action portion of the dialog box. The action can be a Panel Key, an ASCII Key, or a Macro Command.

If Panel Key is selected, clicking on the "..." button brings up the Change / View Panel Key Assignment dialog box where you have a list of panel keys to choose from.

If ASCII Key is chosen, simply enter the character to be sent in the box beside of the ASCII key radio button.

Macro commands represent all of the elementary macro commands that are available from the Keyboard Macro Editor. The touch cells can be programmed using the Keyboard Macro Editor to perform a vast array of functions, such as changing pages of the project file, scrolling down a line, entering Data Entry Mode, and writing a value to the controller. If Macro Command is chosen the Macro button brings up the Define / Edit Macro Command dialog box where Keyboard Macro Editor commands are available.

#### 4.4.157 Enable Indicator

The Enable Indicator checkbox is available with Windows, Windows Custom, and Custom style touch cell buttons. This checkbox allows you to place an indicator light on the button.

#### 4.4.158 Layout

Note: This page is used to show the Layout tab for all the Touch Cells.

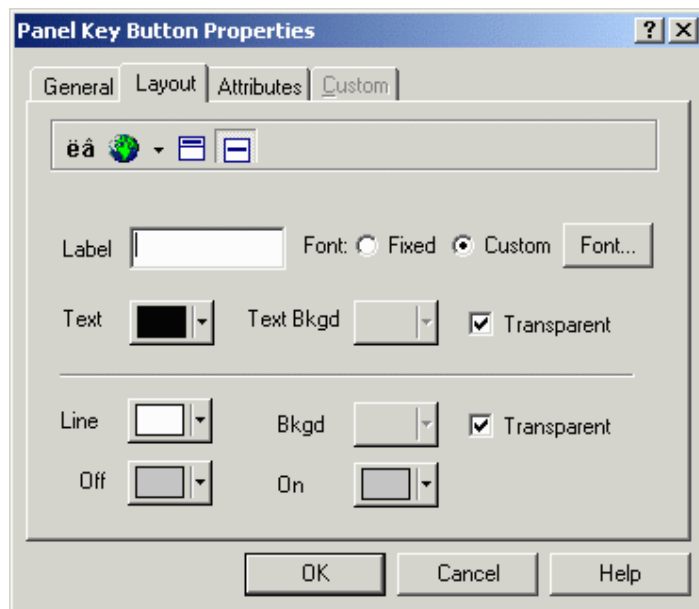

The Layout tab lets you select the colors, font, languages, etc., to be used.

The upper Toolbar portion of the box contains a Special Characters icon, a Languages icon, and label placement buttons.

Clicking on the Special Characters icon brings up the Special Characters dialog box that can be used to enter a special character into the touch cell label.

It is possible to integrate multiple languages within the same touch cell. Clicking on the Languages button brings up the Languages dialog box that lets you choose the language in which you wish to work.

The label placement icons lets you place the label either above the touch cell or centered on the touch cell.

Note: Fixed font text may only be placed above a touch cell.

The top portion of the Layout box includes commands to create and customize a label on the touch cell. For instance, rather than displaying the label F1, a panel key could read Pressure. A toolbar includes icons to customize the label on the touch cell by inserting a special character or by selecting a particular language, and label placement.

The Label box lets you specify the text that is placed either on or on top of the touch cell.

Note: The label must be entered after the key has been selected under the General tab, otherwise the default key label will override any label entered in the Label box.

Clicking on the Font button lets you select the font to be used for a particular touch cell. Once a font is selected, it will continue to be used for all touch cells that are subsequently created.

Note: This font is not a global font and may be changed at any time without affecting any of the previously created touch cells. It is possible to use different fonts on all of the touch cells in a single project file.

Text indicates the color of the touch cell text. Text Bkgd indicates the background color of the touch cell text. This color will only be seen when the Transparent checkbox is not marked, otherwise the background of the touch cell text will appear either in On or in Off color for centered text and in the Background color if the text is on top.

The bottom portion of the Layout box lets you choose the colors to be displayed on the touch cell.

Line color is the color of the lines in the touch cell. Background color is the color of the touch cell background. The touch cell background is a part of the rectangle around the circular or elliptical touch cell not covered by the cell. Rectangular touch cells have no background if the touch cell text is centered, but if it is positioned on top, a strip of background appears above the cell.

On shows the color that the touch cell will be when it is pressed, while Off indicates the color that the touch cell will be when it is in the not-pressed state.

#### **4.4.159**      **Attributes**

Note: This page is used to show the Attribute tab for all the Touch Cells.

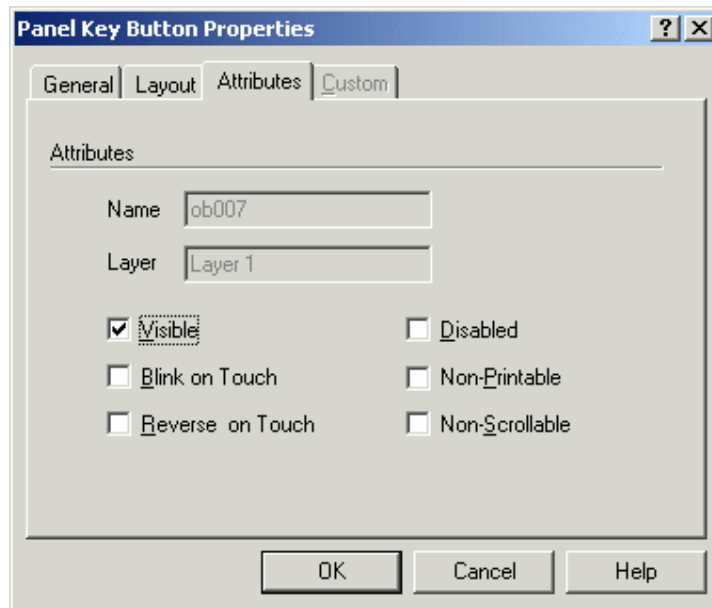

When the button is pressed you can set it to Blink, or for the colors to Reverse.

#### 4.4.160 Custom

By choosing Custom, you can select the source of the graphic that is to be used on the face of the touch cell. This feature gives you the ability to import separate graphics for the pressed and not pressed states. These graphics can be imported either from an external file or from a library.

#### 4.4.161 Generic Command Button Touch Cell Example

In this example, we will configure a custom generic touch cell button.

Select Insert - Touch Cells - Generic Command Button.

Use the cursor to outline an area on the page where the touch cell will appear.

In the Generic Button Properties dialog box, select Windows Custom as the Style.

Under Action, set the Action as Panel Key.

Click on the "..." button to select a panel key to associate with the button.

Check the Enable Indicator box to place an indicator light on the button.

Identify the controller reference location that will be mapped to the button.

From the Layout tab, enter a label for the button, adjust the Font if necessary, and select colors for the Off and On states.

On the Attributes tab check Reverse.

On the Custom tab (visible only when a Custom button style is chosen) you can either press the Edit button and create your own button face, or press the Load button and load an image from a file.

Create a button face, then click OK.

The screen should appear similar to the figure below.

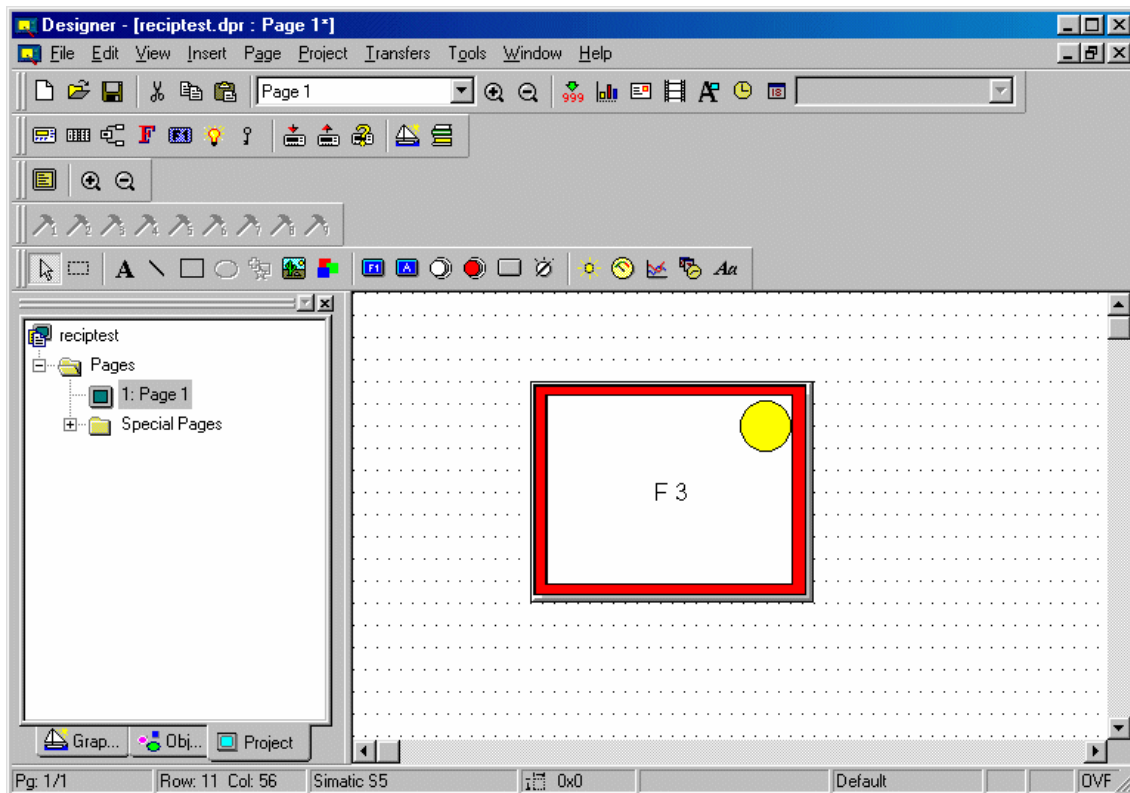

#### 4.4.162 Shapes

#### 4.4.163 Shapes

It is quite easy to add simple shapes using the Designer software, including SVG line, lines, SVG rectangle, rectangles, and ovals. The Shapes submenu under the Insert menu offers these options, or you may click on the individual shape icons in the toolbar.

#### 4.4.164 Line / SVG Line

To insert a line / SVG Line, click on the Line / SVG Line icon in the toolbar, or select Insert - Shapes - Line / SVG Line. Place the cursor where the line is to begin, click once, then move the cursor to where the line is to end and click again. The line will appear. SVG Line can be drawn in any angle.



SVG Line icon is enabled only for firmware version 4.50 and above. The 'Pixel and Vector graphics' option should be enabled under the Panel Setup -> Settings tab.

#### **4.4.165      Rectangle / SVG Rectangle**

To insert a rectangle / SVG rectangle, click on the Rectangle / SVG Rectangle icon in the toolbar, or select Insert - Shapes - Rectangle. Place the cursor at one corner of the rectangle, click once, then move the cursor to the opposite corner of the rectangle and click again. The rectangle will appear.

SVG Rectangle icon is enabled only for firmware version 4.50 and above. The 'Pixel and Vector graphics' option should be enabled under the Panel Setup -> Settings tab.

Note: A rectangle can be used to place a border around a bargraph.

#### **4.4.166      Oval**

To insert an oval, click on the Oval icon in the toolbar, or select Insert - Shapes - Oval. Place the cursor at one side of the oval, click once, then move the cursor to the opposite side of the oval and click again. The oval will appear.

Oval icon is enabled only for firmware version 4.50 and above. The 'Pixel and Vector graphics' option should be enabled under the Panel Setup -> Settings tab.

#### **4.4.167      Trend Window**

#### **4.4.168      Trend Window**

The trend window displays the trend buffer.

Note: Before creating a trend window you must define the Trend Buffer.

To create a trend viewer, select the Trend Viewer icon from the toolbar, or select Trend Window from the Insert menu. Use the cursor to define an area for the trend window. Once the trend window is defined, double-clicking on the trend window brings up the Trend Window Properties dialog box.

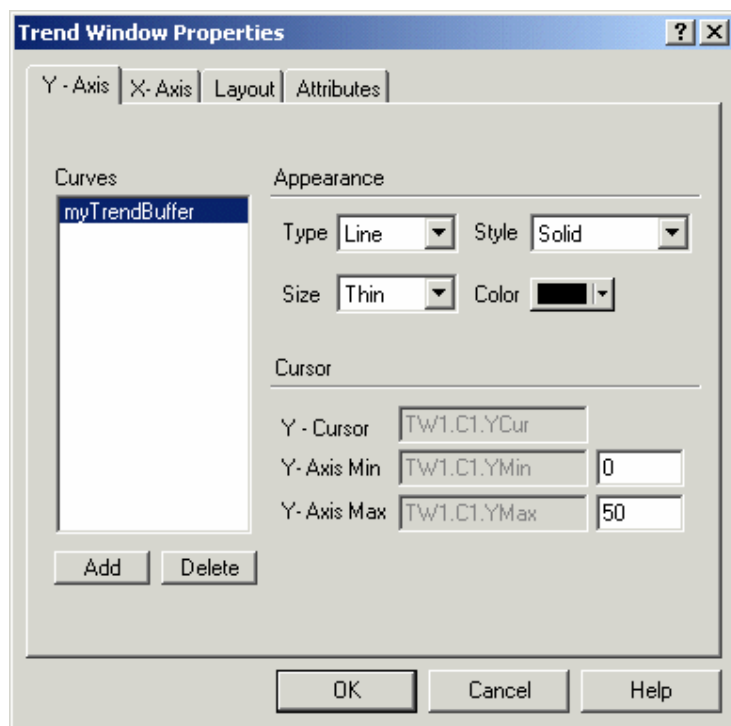

The Trend Window Properties dialog box may also be accessed by right-clicking on the trend field area and selecting Properties.

Within the Trend Viewer Properties dialog box you can define the main trend viewer properties for the X-Axis, the Y-Axis, and the overall layout.

A list of trend window limitations is provided.

#### 4.4.169 Trend Window Limitations

Max number of trend windows inside the same page	10
Max number of curves inside the same trend window	10
Total number of curves that can be use inside the same page	20
Max number of global trend buffers sampled in background	20
Cyclical sampling period	1-9999 sec
The total memory reserved for trend buffer	20 KB
Available memory area in the PLC for storing trend buffers	60 bytes

#### 4.4.170 Preview

The Preview window allows you to see how the trend window will look before it is actually created and placed into a project file.

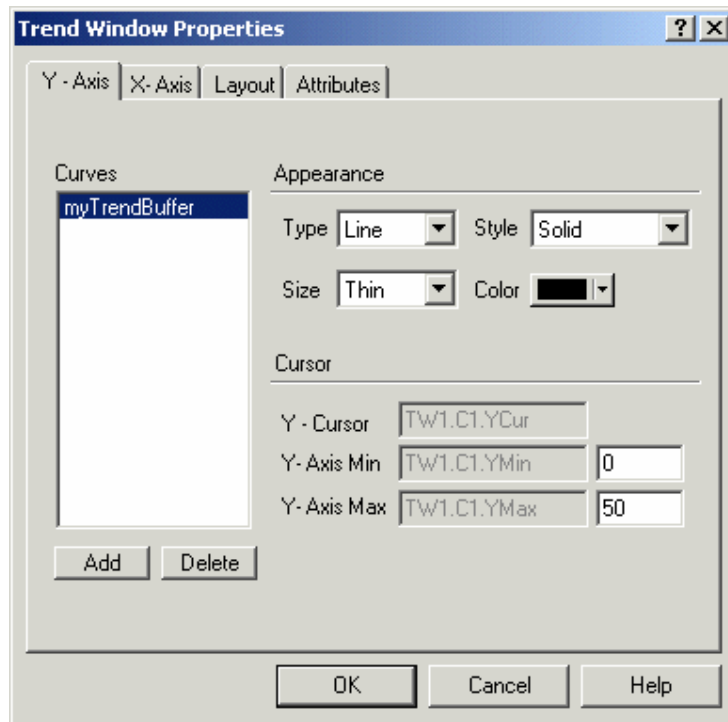
**4.4.171 Y-Axis****4.4.172 Y-Axis**

Selecting the Y-Axis index tab will allow you to select the trend buffers (curves) to be displayed inside the trend viewer. You can also set the appearance of the Y-Axis and configure the trend cursor.

**4.4.173 Curves**

Selecting the Y-Axis index tab will allow you to select the trend buffers (curves) to be displayed inside the trend viewer. Use the Add and Delete buttons to add or remove trend buffers. The Add button opens a dialog box that contains a list of all the active trend buffers that can be used. To remove a previously inserted curve, select it from the Curves list and click the Delete button.

Note: Once a curve is added to the trend viewer, you will only be able to add additional curves of the same sampling method to that particular trend viewer.

**4.4.174 Appearance****4.4.175 Appearance**

For any curve, you can choose the appearance properties such as

Line Type.

Line Style.

Line Size.

Line Color.

#### **4.4.176**      **Type**

Curve type. Can be Line, Step or Filled bar graph.

#### **4.4.177**      **Style**

Curve style. Can be Solid, Dotted, Dashed, Dash Dot or Dash Dot Dot.

Note: The style type is applicable only when curve is line type.

#### **4.4.178**      **Size**

Curve size. Can be Thin, Medium or Thick.

#### **4.4.179**      **Color**

Curve color. The basic 16 colors are supported.

#### **4.4.180**      **Cursor**

#### **4.4.181**      **Cursor**

This variable can be used to display the value of the curve at a point on the Y-axis. The Y-Cursor can be activated, and the Y-Axis Minimum and Maximum values can be set. Use the trend macros to activate the trend cursor.

#### **4.4.182**      **Y Cursor**

This variable can be used to display the value of the curve at a point on the Y-axis. Use the trend macros to activate the trend cursor.

#### **4.4.183**      **Y Axis Minimum**

The minimum value of the defined Y-axis. To the right of the dialog box you can define the default value (Y-axis range) that will be used when the trend viewer is displayed. If you put this internal panel control variable on the UniOP as a read/write field its value can be modified on-line, allowing you to dynamically change the Y-axis range.

## 4.4.184 Y Axis Maximum

The maximum value of the defined Y-axis. To the right of the dialog box you can define the default value (Y-axis range) that will be used when the trend viewer is displayed. If you put this internal panel control variable on the UniOP as a read/write field its value can be modified on-line, allowing you to dynamically change the Y-axis range.

## 4.4.185 X-Axis

## 4.4.186 X-Axis

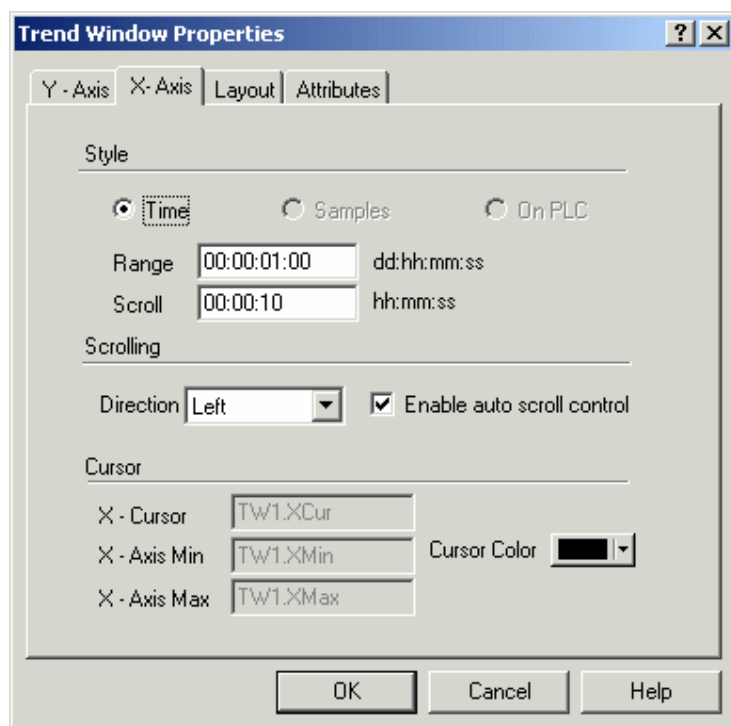

Use this index tab to define the X-axis properties (Style, Scrolling and Cursor) of the trend viewer.

Note: A single X-Axis exists for all of the curves that have been inserted inside the same trend viewer window.

## 4.4.187 Style

## 4.4.188 Style

The format of the X-Axis (Time, Samples or On PLC) is defined from the curves that are inside the trend viewer. When no curves are defined, all of these radio buttons are disabled. After adding one or more curves, only the appropriate radio button is enabled.

**4.4.189 Time**

The X-axis range is time defined. This will be enabled when the trend buffers inside the trend viewer are sampled cyclically from the panel.

**4.4.190 Samples**

The X-axis range is defined by a maximum number of samples. This will be enabled when the trend buffers inside the trend viewer are sampled on PLC events.

**4.4.191 On PLC**

The X-axis range is defined by a maximum number of samples. The number of samples must be defined inside the PLC memory.

**4.4.192 Scrolling****4.4.193 Scrolling**

The scroll parameters (direction and auto scroll control) defines how much the trend viewer will be shifted upon each scroll operation. The scroll parameter can be a fixed amount of time or a fixed number of samples.

**4.4.194 Scroll Direction**

This parameter defines the direction of the curve. The curve can be drawn Left to Right, Right to Left, Up to Down or Down to Up.

**4.4.195 Enable Auto Scroll Control**

Use this checkbox to enable a trend viewer shift when the trend viewer becomes full.

**4.4.196 Cursor****4.4.197 Cursor**

This variable can be used to display the value of the curve at a point on the X-axis. The X-Cursor can be activated, and the X-Axis Minimum and Maximum values and color can be set.

Use the trend macros to activate the trend cursor.

## 4.4.198 X Cursor

This variable can be used to display the value of the curve at a point on the X-axis. Use the trend macros to activate the trend cursor.

## 4.4.199 X Axis Minimum

This variable contains the minimum value of the defined X-axis. You can put this variable on the panel by selecting the Time/Date icons located on the toolbar.

## 4.4.200 X Axis Maximum

This variable contains the maximum value of the defined X-axis. You can put this variable on the panel by selecting the Time/Date icons located on the toolbar.

## 4.4.201 Cursor Color

Color used to draw the X-axis cursor.

## 4.4.202 Layout

## 4.4.203 Layout

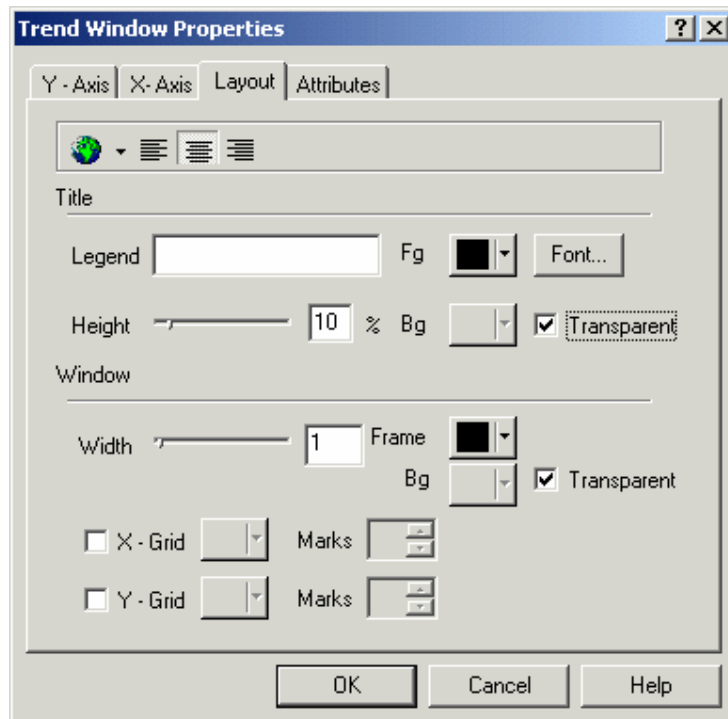

Options in the Layout section define the visual appearance of the trend viewer window, such as the title and window. A layout toolbar is also available.

#### **4.4.204      Layout Toolbar**

#### **4.4.205      Layout Toolbar**

The layout toolbar contains icons to keep frequently used commands easily accessible. These include the following commands

##### Special Characters

Clicking on the Special Characters icon brings up the Special Characters dialog box that can be used to enter a special character.

##### Select Language

It is possible to integrate multiple languages. Clicking on the Select Language button brings up the Languages dialog box that allows you to choose the language in which you wish to work.

##### Alignment.

Title alignment. Can be Left, Right or Center.

#### **4.4.206      Special Characters**

Clicking on the Special Characters icon brings up the Special Characters dialog box that can be used to enter a special character.

#### **4.4.207      Select Language**

It is possible to integrate multiple languages. Clicking on the Select Language button brings up the Languages dialog box that allows you to choose the language in which you wish to work.

#### **4.4.208      Alignment**

Title alignment. Can be Left, Right or Center.



**4.4.209 Title****4.4.210 Title**

In the Title section you can enter title text and format the appearance of the title by setting the font, foreground and background colors, and title height.

**4.4.211 Text**

The text that will be the trend window title or label.

**4.4.212 Font**

Title font.

**4.4.213 Height**

Height of the area reserved for the trend viewer title, as a percentage of the trend viewer.

**4.4.214 Foreground (FG)**

Title foreground color.

**4.4.215 Background (BG)**

Title background color.

**4.4.216 Window****4.4.217 Window**

In the Window section you can format the appearance of the window by setting the frame color and width, the background color, and to enable a horizontal or vertical grid, set the horizontal grid color or vertical grid color, and set the horizontal grid marks or vertical grid marks.

**4.4.218 Frame**

Trend frame color.

**4.4.219 Width**

Trend frame width as a percentage of the trend window. Set to 0 for no frame.

**4.4.220 Background Color**

Trend frame window background color.

**4.4.221 X Grid**

Check the box to enable a horizontal grid in the viewer window.

**4.4.222 X Grid Color**

Color of the horizontal grid.

**4.4.223 X Grid Marks**

Number of horizontal grid lines.

**4.4.224 Y Grid**

Check the box to enable a vertical grid in the viewer window.

**4.4.225 Y Grid Color**

Color of the vertical grid.

**4.4.226 Y Grid Marks**

Number of vertical grid lines.

**4.4.227 Trend Window Example**

A trend buffer must be created before a trend window can be created. Select Trend Buffers from the Project menu.

Click on the Insert Item button above the buffers list.

Name the new buffer.

Click OK to accept the default settings for the trend buffer and return to the project page.

Select Trend Window from the Insert menu.

Use the cursor to define an area for the trend window.

In the Trend Window Properties dialog box click on the Add button.

From the Choose Trend Buffer list select the trend buffer that you created in steps 1-4.

Click OK to return to the Trend Window Properties dialog box.

Select the Layout tab.

Enter a label for the trend window in the Text box.

Click OK to accept the trend window settings and return to the project page where the trend window is now displayed.

#### **4.4.228 Meter Instrument**

#### **4.4.229 Meter Instrument**

Meter instruments are simple instruments, such as gauges, that display numerical values by moving a needle to the appropriate position over a labeled scale. The look of a meter instrument can be changed to suit your the needs. Up to ten (10) meter instruments can be displayed on a single page within a project.

To insert a gauge in Designer, click on the Meter Instrument icon and use the cursor to define an area where the gauge is to appear, or select Meter Instrument from the Insert menu. The Meter Instrument Properties dialog box will appear where the appearance and action of a meter instrument may be configured.

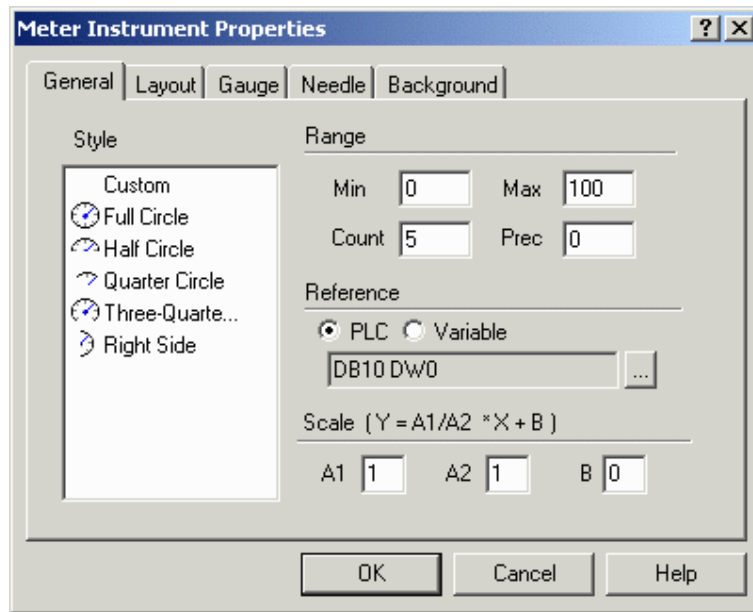

There are five tabs in the Meter Instrument Properties dialog box. They are: General, Layout, Gauge, Needle, and Background.

The General tab allows you to select the style and range of the meter gauge, the memory location that is to be represented, and scale the output if necessary.

The Layout tab lets you select the colors, font, languages, etc., to be used.

On the Gauge tab you can set the rotation direction, format the ticks on the dial, and set the arc colors.

The Needle tab allows you to customize the color and size of the gauge indicator needle.

The Background tab lets you insert a custom background if you wish.

An external small window allows to Preview the Meter Instrument.

**4.4.230 Preview**

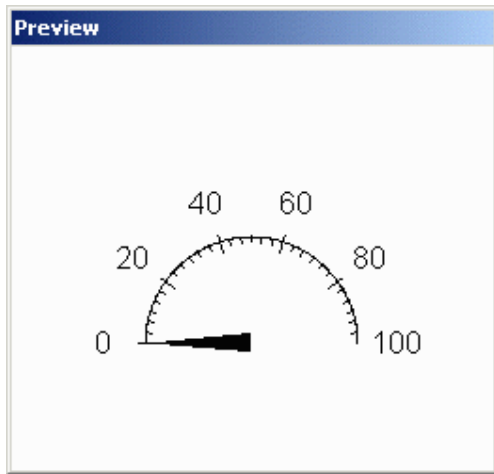

The Preview window allows you to see how the gauge will look before it is actually created and placed into a project file.

**4.4.231 General**

**4.4.232 General**

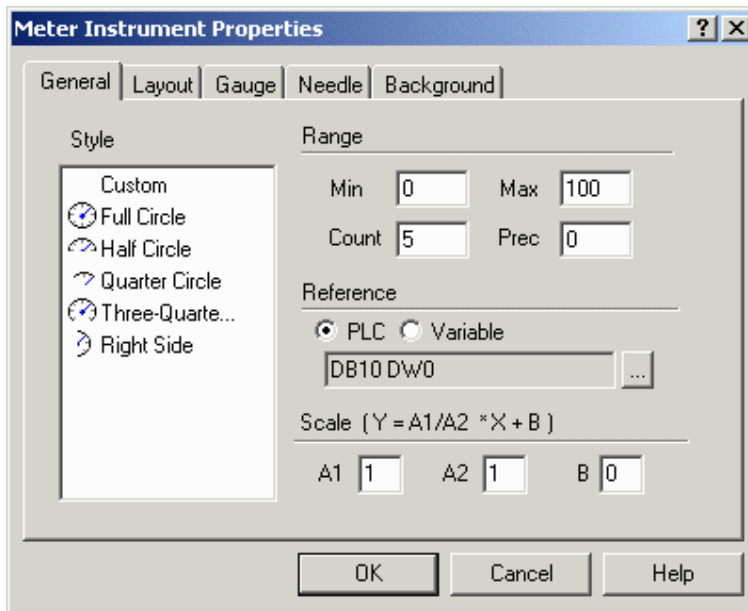

Within this index tab, you can enter the main properties that define the gauge, such as the style, range, reference location and any necessary scaling.

**4.4.233 Style**

The style of gauge to be inserted (full circle, half circle, etc.). Custom gauges may also be created.

**4.4.234 Range****4.4.235 Range**

The minimum and maximum scale values, the number of value labels to be shown on the gauge, and the gauge precision.

**4.4.236 Minimum**

Minimum and value on the gauge scale.

**4.4.237 Maximum**

Maximum value on the gauge scale.

**4.4.238 Count**

The number of values (in addition to zero) to be shown on the gauge. The values shown will be computed by dividing the maximum value by the count.

**4.4.239 Precision**

The precision, or number of digits to the right of the decimal point that are to be displayed on the gauge. A value of zero means that only integer values will be displayed.

**4.4.240 Reference**

Defines the variable that is to be graphically represented. Variables can be PLC references or internal panel variables. Clicking on the "..." button for PLC references brings up the Data Fields Properties dialog box where the reference location may be set.

**4.4.241 Scale**

The scaling parameter may be used to perform a linear transformation on the value to be displayed. Specify the scaling operators A1, A2, and B for the equation  $Y=A1/A2*X+B$  in the boxes.

#### 4.4.242 Layout

#### 4.4.243 Layout

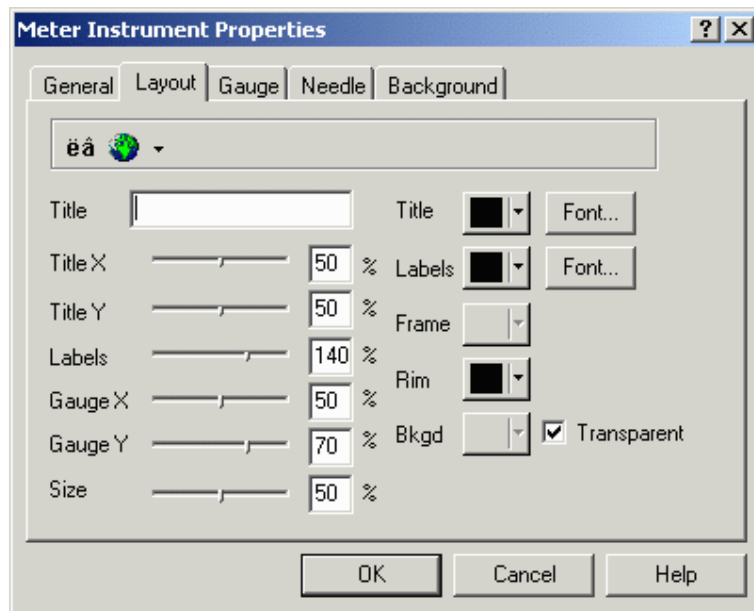

The parameters within this index tab are used to define the layout of the gauge.

These include the Title text, the Title X size, the Title Y size, the Labels, the Gauge X size, the Gauge Y size, the overall gauge Size, the Title color and Font, the Labels color color and Font, the Frame color, the Rim color, and the Background color.

A Layout Toolbar keeps the Special Characters and Languages commands handy.

#### 4.4.244 Layout Toolbar

The Layout Toolbar keeps the Special Characters and Languages commands handy.

#### 4.4.245 Layout Properties

#### 4.4.246 Title

This is the title for the gauge.

**4.4.247 Title X**

The position of the title on the x-axis. A value of 50% is in the middle of the box area, 0% is on the left border and 100% on the right border.

**4.4.248 Title Y**

The position of the title on the y-axis. A value of 50% is in the middle of the box area, 0% is on the upper border and 100% on the bottom border.

**4.4.249 Labels**

The position of the numeric labels on the gauge. A value of 100% is on the gauge scale circle. Greater than 100% is outside the scale and less than 100% is inside the scale.

**4.4.250 Gauge X**

The position of the gauge on the x-axis. A value of 50% is in the middle of the box area, 0% is on the left border and 100% is on the right border.

**4.4.251 Gauge Y**

The position of the gauge on the y-axis. A value of 50% is in the middle of the box area, 0% is on the upper border and 100% is on the lower border.

**4.4.252 Size**

The size of the gauge as a percentage (0-100%) of the smallest side of the box.

**4.4.253 Title Color**

The color in which the title text will be displayed.

**4.4.254 Title Font**

The font in which the gauge title will be displayed. (Can be selected from installed Touchscreen fonts).

**4.4.255 Labels Color**

The color in which the title text will be displayed.



**4.4.256 Labels Font**

The font in which the numeric labels on the gauge will be displayed. (Can be selected from installed Touchscreen fonts).

**4.4.257 Frame**

The color of the box frame around the gauge.

Note: A frame color is not used when the background is a custom bitmap.

**4.4.258 Rim**

The color of the gauge scale and ticks.

Note: A rim color is not used when the background is a custom bitmap.

**4.4.259 Background**

The background color of the gauge box.

**4.4.260 Gauge**

**4.4.261 Gauge**

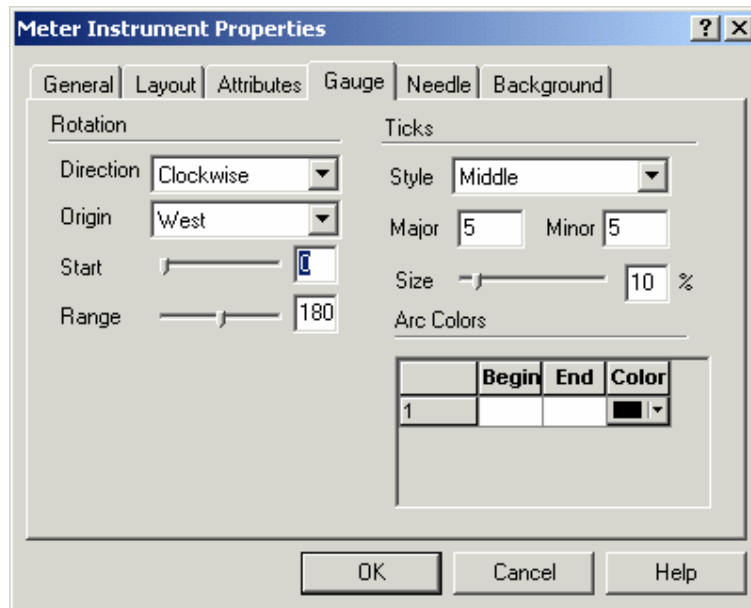

On the Gauge tab you can format the Rotation and Ticks on the dial, and set the Arc Colors.

**4.4.262 Rotation**

**4.4.263 Rotation**

Under the Rotation section you can set the rotation direction, the origin point, start position, and range.

**4.4.264 Direction**

The rotation direction of the gauge needle. Can be clockwise or counterclockwise.

**4.4.265 Origin**

The position of the gauge origin point (zero). Choices are East, North, West and South.

**4.4.266 Start**

Scale start angle. It can be from 0° to 360°.

**4.4.267 Range**

Scale range. It can be from 0° to 360°, with 0° being a single point and 360° a full circle.

**4.4.268 Ticks****4.4.269 Ticks**

In the Ticks section you can set the style for the ticks, the number of major and minor ticks, and the size of the ticks.

**4.4.270 Style**

The position of the ticks on the gauge scale. Can be Outside or in the Middle of the scale.

**4.4.271 Major**

Number of major ticks on the scale.

Note: If a number less than the Range count is entered, the Range count becomes the default value.

**4.4.272 Minor**

Number of minor ticks (ticks between major ticks) on the scale.

**4.4.273 Size**

Size, in percentage of the gauge circle, of major ticks. Minor ticks are generally half the size of major ticks.

**4.4.274 Arc Colors**

These parameters are used to define different colored zones on the gauge. To define a color range on the gauge, enter the Begin and End label values in the boxes provided. Select a color for that zone. Boxes for an additional zone are created whenever a value is entered in existing boxes. To delete a color zone, remove the label values from the Begin and End boxes.

**4.4.275 Needle**

**4.4.276 Needle**

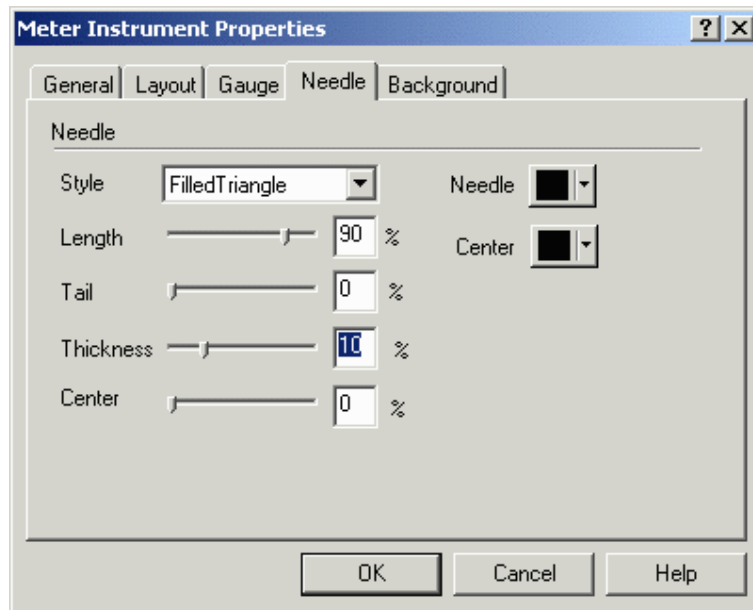

On the Needle tab you can format the needle Style, Length, Tail size, tail Thickness, Center size, Needle color and Center color.

**4.4.277 Style**

The style of needle to be used. Choices include Thick, Triangle, and Filled Triangle.

**4.4.278 Length**

Needle length expressed as a percentage of the gauge radius.

**4.4.279 Tail**

Needle tail length expressed as a percentage of the gauge radius.

**4.4.280 Thickness**

Needle thickness expressed as a percentage of the gauge radius.

## 4.4.281 Center

The circle that highlights the needle rotation point. The size of this circle is defined as a percentage of the gauge diameter.

## 4.4.282 Needle Color

Color of the needle body.

## 4.4.283 Center Color

Color of the needle center.

## 4.4.284 Background

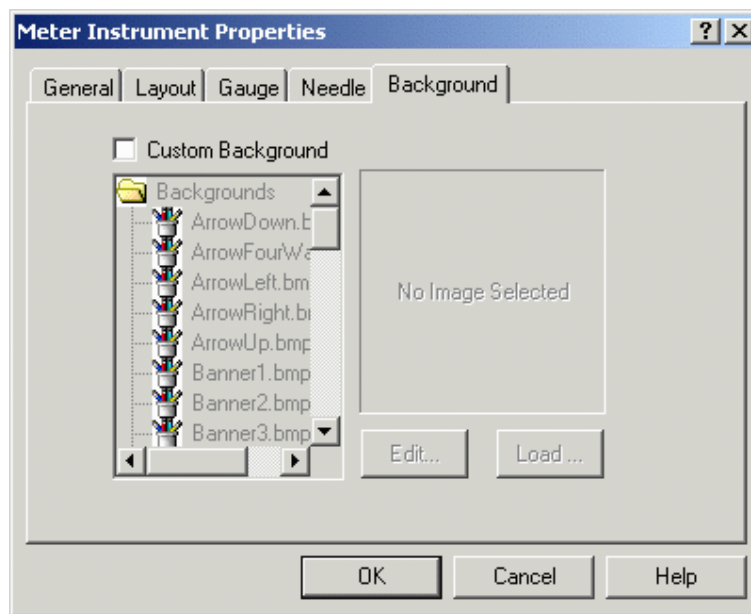

Check the Custom Background checkbox to enable the custom background commands. This lets you enter a custom bitmap as the background for the gauge.

The bitmap can come from an external file or from the Graphics Library Manager that is supplied with Designer.

Select the image source to be used, select the bitmap and click the Load image button. Use the Edit button to edit the bitmap size and colors.

## 4.4.285 Meter Instrument Example

From the Insert menu select Meter Instrument.

Use the cursor to define an area for the meter instrument.

From the Meter Instrument Properties dialog box select Full Circle as the meter Style.

Under Range, insert 10 in the Count box to have labels at 10, 20, 30, etc.

Select the Layout tab and enter a Title for the meter.

By default the title is in the center of the meter. Slide the Title Y selector to a value of 85% or 90% to place the title towards the bottom of the meter window.

Adjust the Size of the gauge as necessary to fit the area defined in step 2.

Select the Gauge tab.

Under Ticks, enter a value of 10 for Major and 10 for Minor. This puts a major tick at each of the 10 labels, and a minor tick at each whole value.

Select the Needle tab.

Set the Needle and Center colors to red.

Set the Center value to 15%.

Click OK to accept the meter settings and close the Meter Instrument Properties dialog box.

The meter instrument appears on the project page.

#### **4.4.286 Trend Time Field**

#### **4.4.287 Trend Time Field**

Trend Time Field is a panel internal control variable related to trend components. It shows the trend sampling time used on the x-axis.

To insert a trend time field in Designer, click on the Trend Time Field icon and use the cursor to define an area where the field is to appear, or select Trend Time Field from the Insert menu. The Trend Time Field Properties dialog box will appear where the contents and layout of a trend time field may be configured.

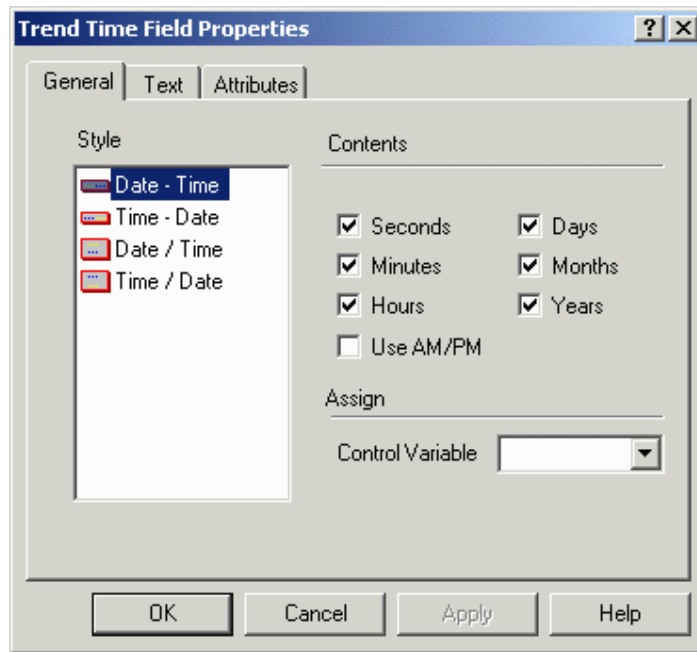

There are two tabs in the Trend Time Field Properties dialog box. They are General and Layout.

The General tab allows you to select the style and contents of the trend time field, and the memory location that is to be represented.

The Layout tab lets you select the colors, font, etc., to be used.

An external small window allows to Preview the Trend Time Field.

#### 4.4.288 Preview

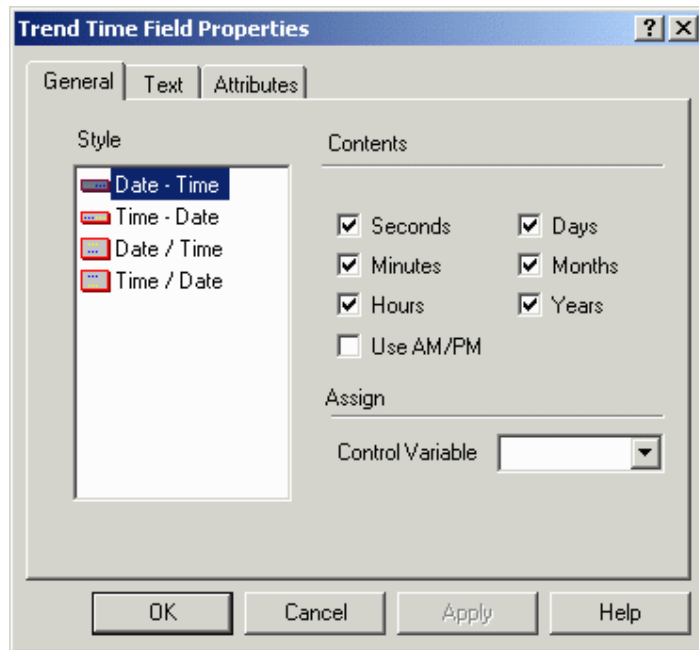

The Preview window shows how the field will look on the panel screen.

**4.4.289 General****4.4.290 General**

The General tab includes commands (Style, Contents and Assign) that let you customize the appearance of the trend time field.

**4.4.291 Style**

The Style section lists several options for the appearance of the trend time field. These include Date - Time, in which the date is followed by the time in a horizontal format, Time - Date, in which the time is followed by the date in a horizontal format, Date / Time, in which the date is listed above the time, and Time / Date, in which the time is listed above the date.

**4.4.292 Contents**

Checkboxes allow you to include seconds, minutes or hours in the time, and days, months or years in the date. You also have the option of specifying an AM/PM format for the time.

**4.4.293 Assign**

Choose the appropriate control variable from the list.

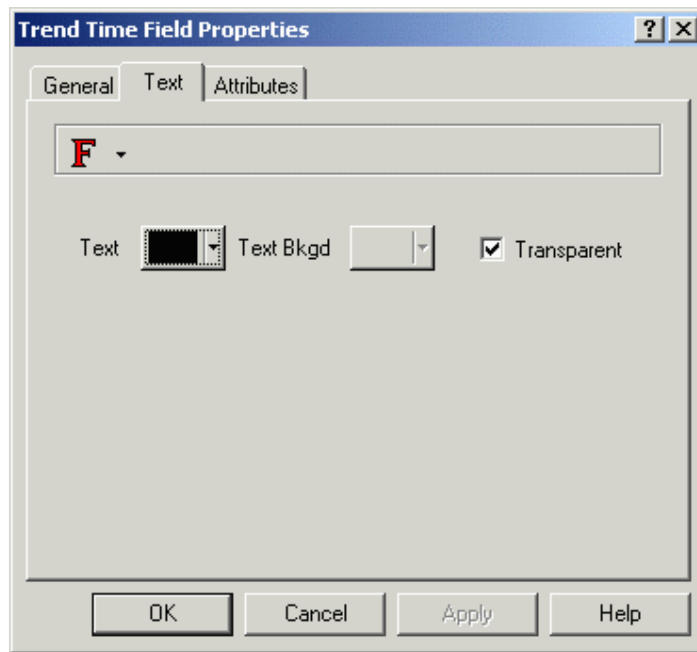

**4.4.294 Text**

The Text tab allows you to set the Panel Font, the text, text background, and background colors, or to make the background transparent.

**4.4.295 Trend Time Field Example**

Select Trend Time Field from the Insert menu.

Select Time - Date as the Style.

Remove the checkbox from the Years box to display only the days and months. The date display format is now DD-MM. Assume that we wish to have the date displayed as MM-DD. This will be set in step 6.

Under Assign, select a Control Variable.

Click OK to accept the settings and return to the project page where the new trend time field is now displayed.

To change the date display format, select Panel Setup from the Project menu.

Select the Settings tab.

Under Date Format choose the setting MM/DD/YY.

Click OK.

The trend time field date is now displayed as MM-DD.

#### 4.4.296 Recipe Menu

#### 4.4.297 Recipe Menu

A recipe menu is a feature that simplifies recipe parameter set selection on UniOP panels through a user-friendly interface. It provides a menu-like field that can contain names to describe the parameter set instead of using numbers. Each name represents one recipe parameter set. To add a recipe menu select Recipe Menu from the Insert menu, or press Ctrl+R.

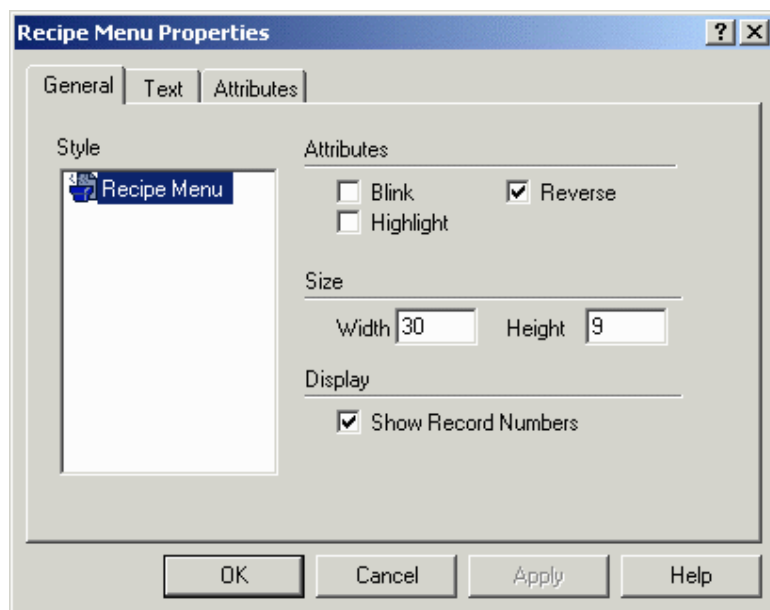

The Recipe Menu Properties dialog box appears containing two tabs; General and Text. The General tab controls the size and appearance of the recipe menu while the Text tab controls the appearance of the text.

Note: In order to use the Recipe Menu, each Recipe Parameter Set must be given a name. This is done by adding a recipe data field with an ASCII display format on the page where the recipe is located and filling the Recipe Item values in the Recipe Configuration box with an ASCII name for each parameter set. This ASCII field is called a Recipe Name field. This field is not a field type name; it only describes the field's purpose.

A set of keyboard macro commands support recipe menus:

The Go To Recipe Menu macro jumps to a specified page and sets the value of the Recipe Page For Selection.

The Scroll Recipe Menu macro is used to move the selection in the recipe menu field. This is the way that a new recipe parameter set name is chosen from the list.

The Confirm Recipe Menu Selection macro changes the current recipe parameter set to the one selected in the recipe menu field.

Note: If a control variable data item set as Recipe Page For Selection contains the page number of a page without a Recipe Name field defined, the recipe menu field will display asterisks ("\*\*").

An example of adding a recipe menu field is provided.

#### 4.4.298 General

#### 4.4.299 General

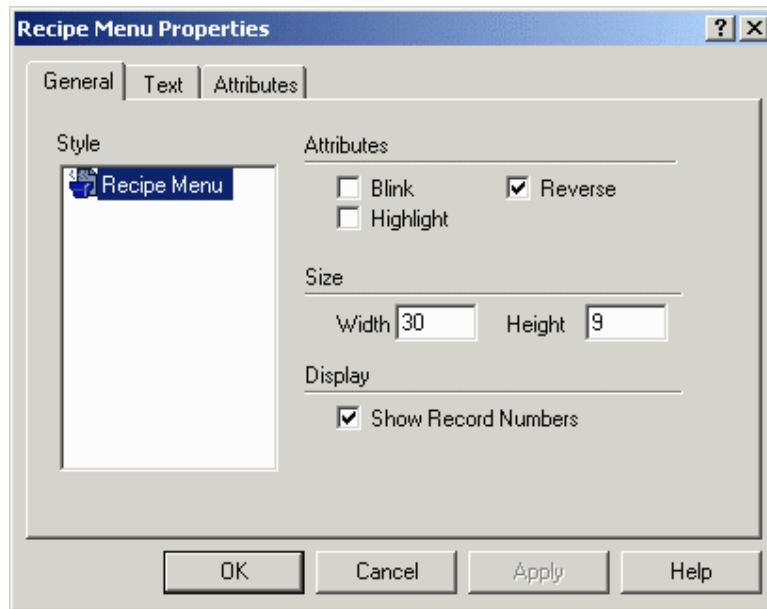

The General tab allows you to set the recipe menu style, attributes, size, and includes the option to show the record numbers.

#### 4.4.300 Style

Recipe Menu is the only choice available.

#### 4.4.301 Attributes

The currently selected Recipe Parameter Set may be indicated using user defined attribute combinations (blink, highlight, reverse).

#### 4.4.302 Size

The size (in pixels) of the Recipe Menu display.

## 4.4.303 Display

Click the Show Record Numbers checkbox to show record numbers (which are just the parameter set numbers) together with the recipe name.

## 4.4.304 Text

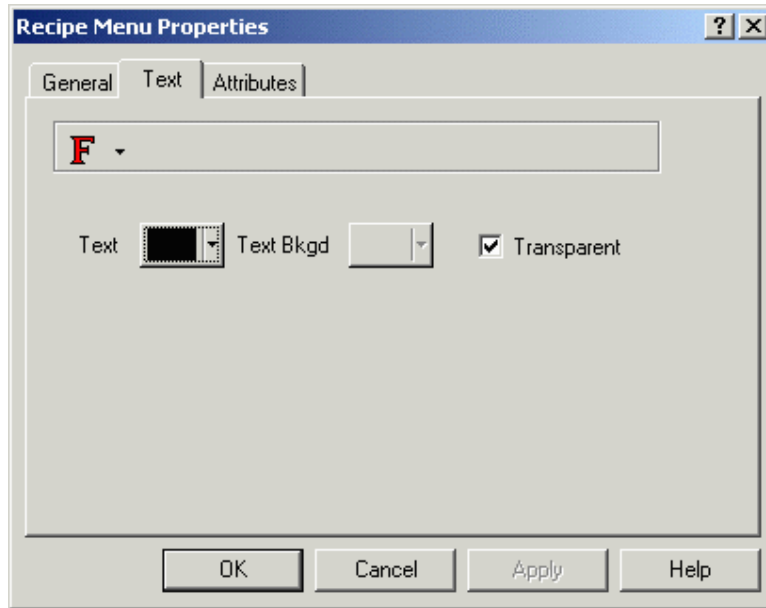

The Text tab allows you to set the font size and color, and the background color and transparency.

Designer will not let you select a size that is too large to be displayed in the designated area.

If Transparent is selected then text background colors are not available.

**4.4.305 Special Characters**

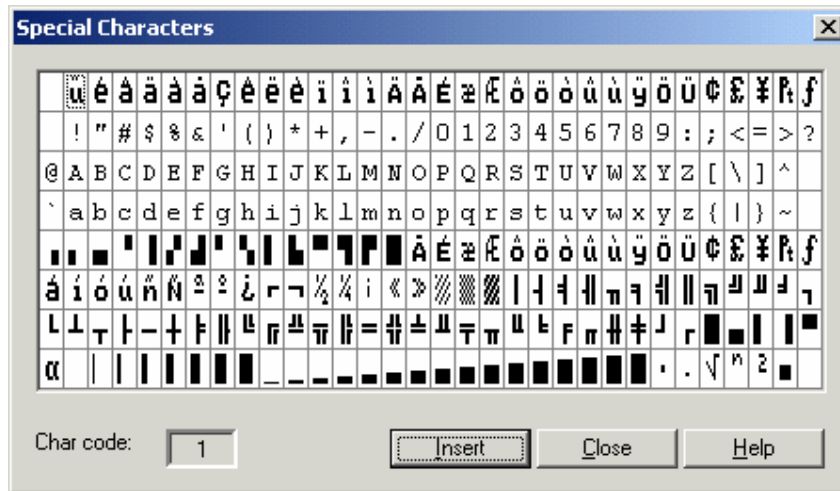

Special characters may be added to text by clicking on the Special Characters button. This will bring up the Special Characters dialog box in which you can select the character(s) to be used by double clicking on them or by single clicking on them and pressing Insert. The characters will appear in the last position the cursor was in before entering the special characters dialog box.

**4.4.306 Import Bitmap Graphics**

**4.4.307 Import Bitmap Graphics**

When using a UniOP graphics-capable panel you may import, display, and manipulate graphics in a project file. Once the graphic is imported into the project file, it may be easily moved or resized.

Click on the Import Graphics icon on the toolbar, or select Import Bitmap Graphics from the Insert menu. The Open dialog box appears with a list of files or folders.

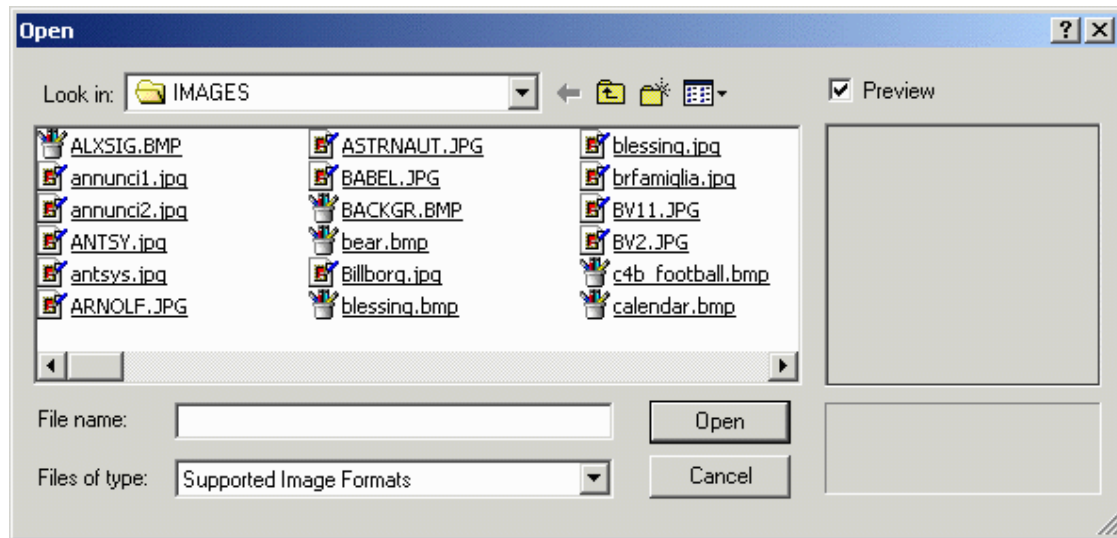

Select a graphic image to import and click on the Open button.

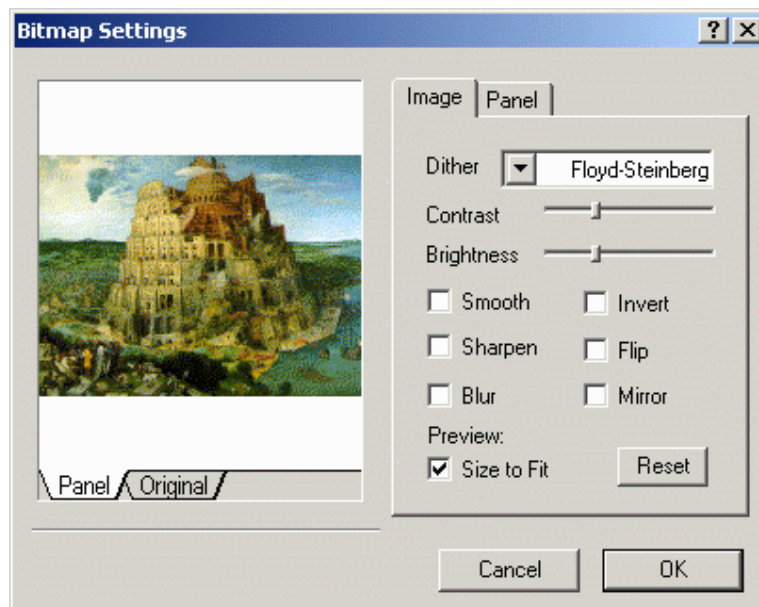

The Bitmap Settings dialog box appears showing a preview of the image, with two tabs labeled Image and Panel.

Options are available for changing the appearance of the image on the panel. Image shows the original image, while Panel shows how the image will appear on the panel.

Note: Only files in supported image formats may be imported using the Import Bitmap Graphics box i.e.

- Windows and OS/2 Bitmaps(\*.bmp, \*.dib,\*.rle)
- JPEG \*.jpeg
- AutoCAD files (\*.dwg, \*.dxf, \*.dwf)
- Scalable Vector graphics \*.svg
- Windows Metafile \*.wmf
- Enhanced Metafile \*.emf

Windows Icons and Cursors (\*.ico;\*.cur)  
TIFF (\*.tif;\*.tiff)  
Adobe Photoshop \*.psd  
WordPerfect \*.wpg  
Portable Network Graphics \*.png  
Kodak PhotoCD \*.pcd  
Kodak FlashPix \*.fpx  
ZSoft PCX and DCX (\*.pcx;\*.dcx)  
TARGA \*.tga  
Encapsulated Postscript \*.eps  
Macintosh PICT \*.pct  
Sun Raster \*.ras  
MacPaint \*.mac  
GEM Image \*.img  
Gerber \*.gbr  
Computer graphics metafile \*.cgm  
DRW \*.drw  
Intergraph Microstation Format \*.dgn  
ESRI shape format \*.shp

A graphic can be moved or resized once it is imported. To move a graphic, simply single click the left mouse button over the graphic and move it to the desired location. To resize a graphic, single click the left mouse button once on the graphic and use one of the selection handles that will appear around the edge of the graphic.

Note: Resizing a graphic image by using the selection handles may distort the image.

To duplicate or copy a graphic within the same page, left-click on the image then click on the Copy icon, select Copy from the Edit menu, or right-click on the image and select Copy. Click where the copy of the image is to be placed, then click the Paste icon or select Paste from the Edit menu, or right-click and select Paste.

To delete a bitmap graphic, left-click on the graphic to select it and press the Delete key or click on the Cut tool, or right-click on the image and select Cut.

Right-click on a bitmap image and select Edit to open the Bitmap Editor dialog box.

Right-click on a bitmap image and select Properties to view the image properties, such as the image file name, the image height and width in pixels, and the image resolution.

Dynamic graphics and transparent and three-dimensional touch cells may be placed over static bitmaps.

A bitmap graphics example is provided.

#### **4.4.308 Import Bitmap Graphics Example**

The following steps are used to import a bitmap file:

Select Import Bitmap Graphics from the Insert menu. This will open a dialog box from which you can select a file.

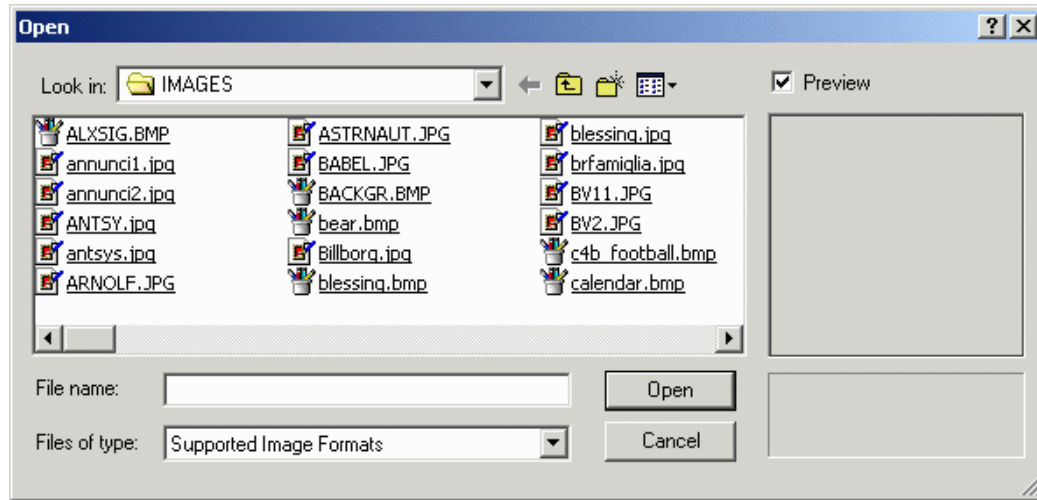

Check the Preview box to view files before selection. Select the filename that is to be used and click on Open.

The Bitmap Settings dialog box, shown below, appears. From this dialog box you can change the name of the file and change its appearance.

Click OK.

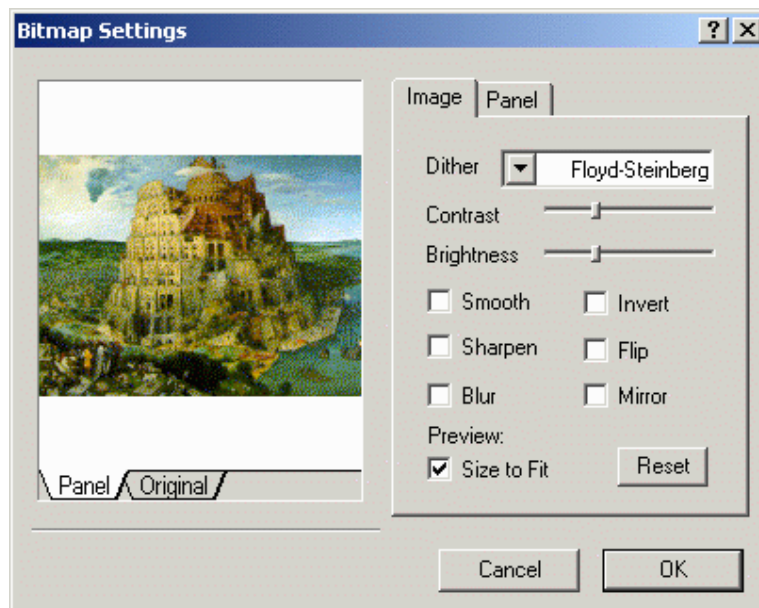

The graphic appears in the upper left corner of the project page. You can then move it to the desired position on the project page, or resize it. To move a graphic, simply single click the left mouse button over the graphic and move it to the desired location. To resize a graphic, single click the left mouse button once on the graphic and use one of the selection handles that will appear. To duplicate or copy a graphic within the same page, hold the Ctrl key down and click on the graphic. Drag the duplicated graphic to a new location and release the mouse button. To delete a bitmap graphic, click on the graphic to select it and either press the Delete key or click on the Cut tool.



**4.4.309 Preview**

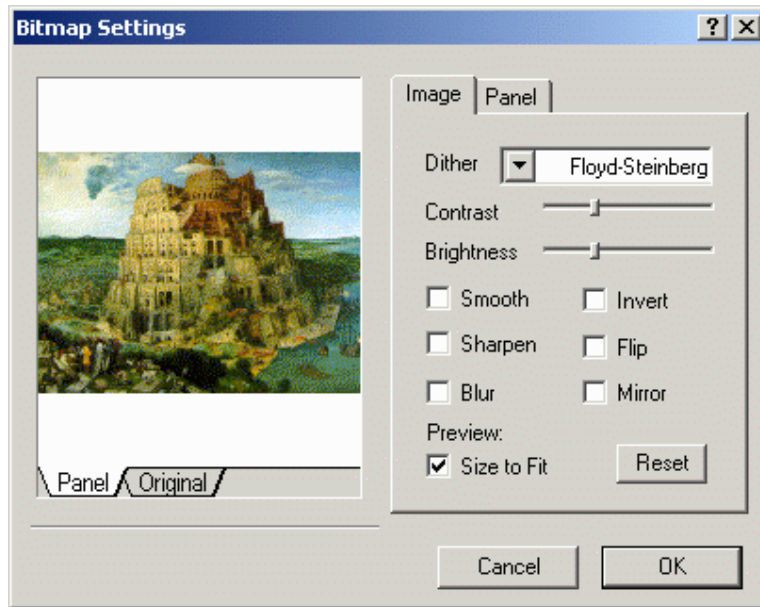

The bitmap graphics preview image has two tabs, labeled Panel and Original. The Panel tab displays the way the image will appear on the panel, while the Original tab displays the original image appearance for reference. The image file name appears under the preview window.

**4.4.310 Panel**

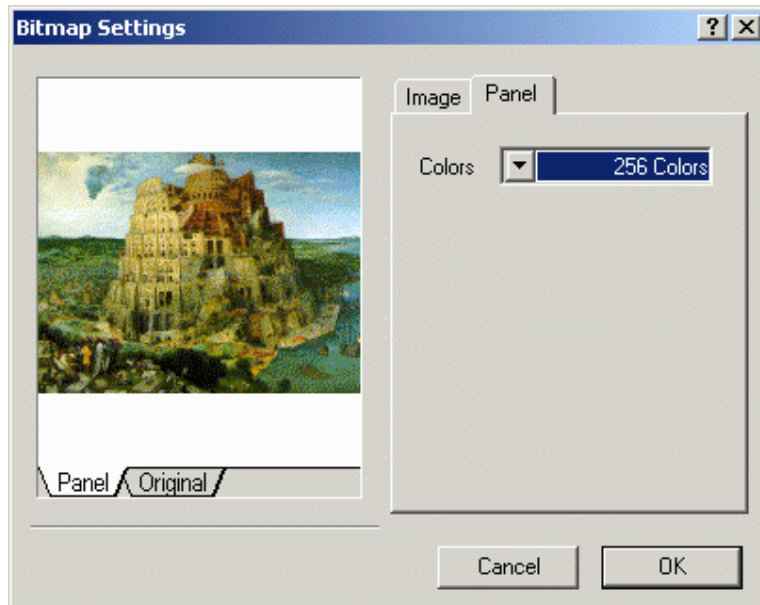

Sets the number of colors for the image display on the panel, for example black/white or 16 colors.

## 4.4.311 Properties

Right-click on a bitmap image and select Properties to view the image properties, such as the image file name, the image height and width in pixels, and the image resolution.

## 4.4.312 Image

## 4.4.313 Image

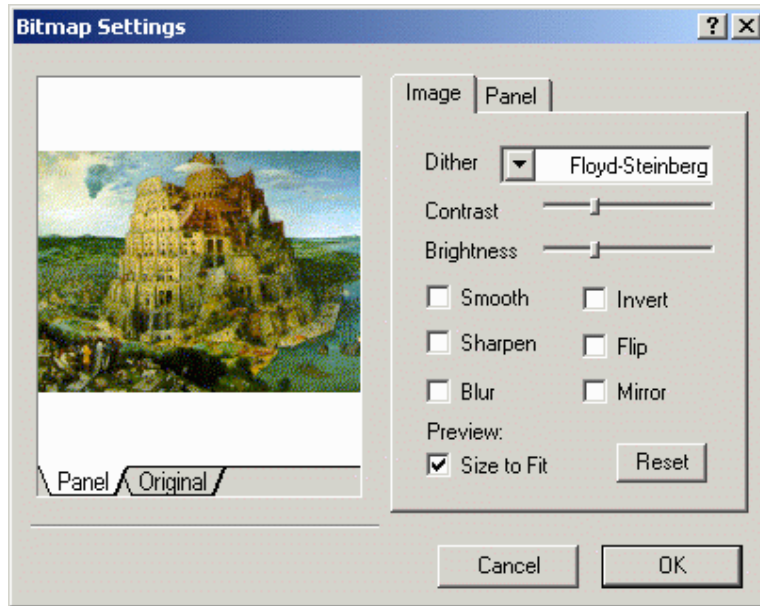

There are a number of controls available to change the appearance of the image. They include:

Dither

Contrast

Brightness

Smooth

Sharpen

Blur

Size to Fit

Invert

Flip

Mirror

Reset

**4.4.314 Dither**

Various methods to dither the image are available, including Floyd-Steinberg, Bayer, etc.

**4.4.315 Contrast**

A sliding bar lets you adjust the image contrast.

**4.4.316 Brightness**

A sliding bar allows you to adjust the image brightness from darker to lighter.

**4.4.317 Smooth**

Smooths jagged pixel edges in the image.

**4.4.318 Sharpen**

Sharpens the image.

**4.4.319 Blur**

Blurs the sharp lines in the image.

**4.4.320 Size to Fit**

Sizes the image to fit the available space.

**4.4.321 Invert**

Produces a negative image.

**4.4.322 Flip**

Turns the image upside down.

**4.4.323 Mirror**

Turns the image backwards.

**4.4.324 Reset**

Resets the image appearance to the default settings.

## 4.5 Page Menu

### 4.5.1 Page Menu

This section provides information about the Page menu. The Page menu contains commands that let you easily move from one project page to another, and to configure the various pages within a project.

Insert Page

Add Page

Delete Page

Go to Page

Previous Page

Next Page

Page Options

Recipe Configuration

Special Pages and Page Modes

### 4.5.2 Insert Page

This option lets you insert a blank page in front of the page that you are currently viewing. For example, if you are on page 3 of a project file and select Insert Page, the present page 3 would become page 4, and a blank page would be inserted as page 3. You can also access the Insert Page command by pressing the Alt+Ins keys.

### 4.5.3 Add Page

Selecting this command adds a new page to the end of the project file. You can also access the Add Page command by pressing the F7 function key.

### 4.5.4 Delete Page

Selecting this command deletes the currently selected page within the project file. You will be prompted to confirm the operation. The pages of the project file will automatically be renumbered. You can also access the Delete Page command by pressing the Shift+F7 keys.

#### 4.5.5 Go to Page

This dialog box is one method available for selecting a page in a project. Select a page from the pull-down list in the Go to page dialog box, or type the page number in the entry field provided.

Other methods for selecting a particular page in a project include selecting a page from the pull-down Current page list on the toolbar, double-clicking on a page from the Project tab in the workspace, or by pressing the Ctrl+G keys.

#### 4.5.6 Previous Page

Selecting this option displays the previous page in the project. Pressing the Page Up key also displays the previous page.

#### 4.5.7 Next Page

Selecting this option displays the next page in the project. Pressing the Page Down key also displays the next page.

#### 4.5.8 Page Options

#### 4.5.9 Page Options

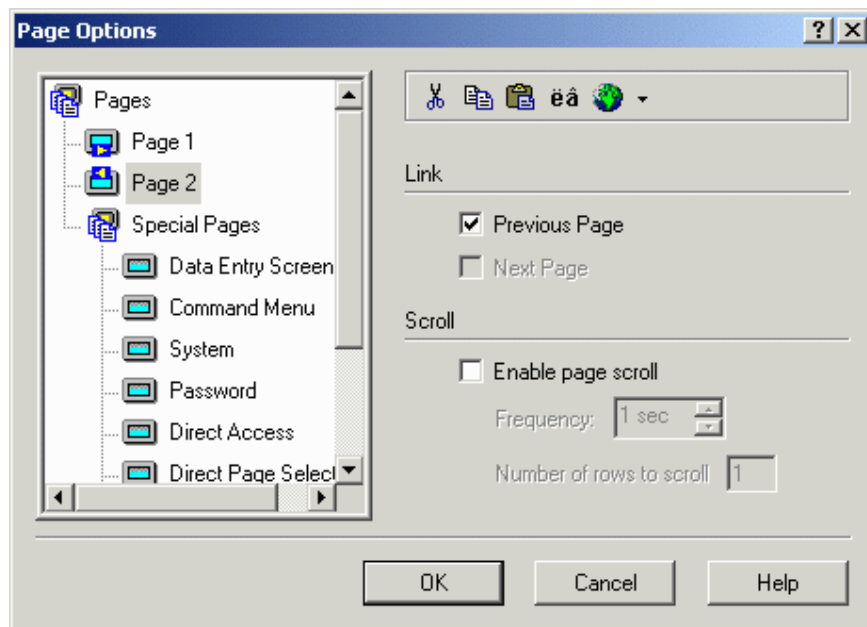

The Page Options dialog box lets you:

Select a page from a page list,

Access tools from a convenient toolbar,

Link to other pages, and

Enable page scroll.

#### **4.5.10 Page List**

This section lists all the pages in the current project. You can rename a page by single-clicking on the page name, then typing a new page name.

#### **4.5.11 Toolbar**

The toolbar includes icons that allow you to cut, copy, paste, insert special characters, and select a language.

#### **4.5.12 Link**

Link the current page to the previous page or to the next page.

#### **4.5.13 Scroll**

This command enables a page scroll frequency and the number of lines to scroll. This allows you to see lines that may be off the screen without having to use the arrow keys to scroll through the information.

When pages are linked, the left and right arrow keys on the display panel may be used to scroll between pages. By default, the current page is linked to both the previous page and the next page.

Note: If you are having problems using this feature, check the RDA setup under Panel Controller Interface in the Project menu. Make sure that the PR box within the section entitled PLC is unchecked.

#### **4.5.14 Recipe Configuration**

#### **4.5.15 Recipe Configuration**

A recipe is associated with a particular page and is composed of all the recipe data fields on that page.

However, there can be a number of different parameter sets for a recipe.

The Recipe Configuration dialog box is accessed by selecting Recipe Configuration from the Page menu.

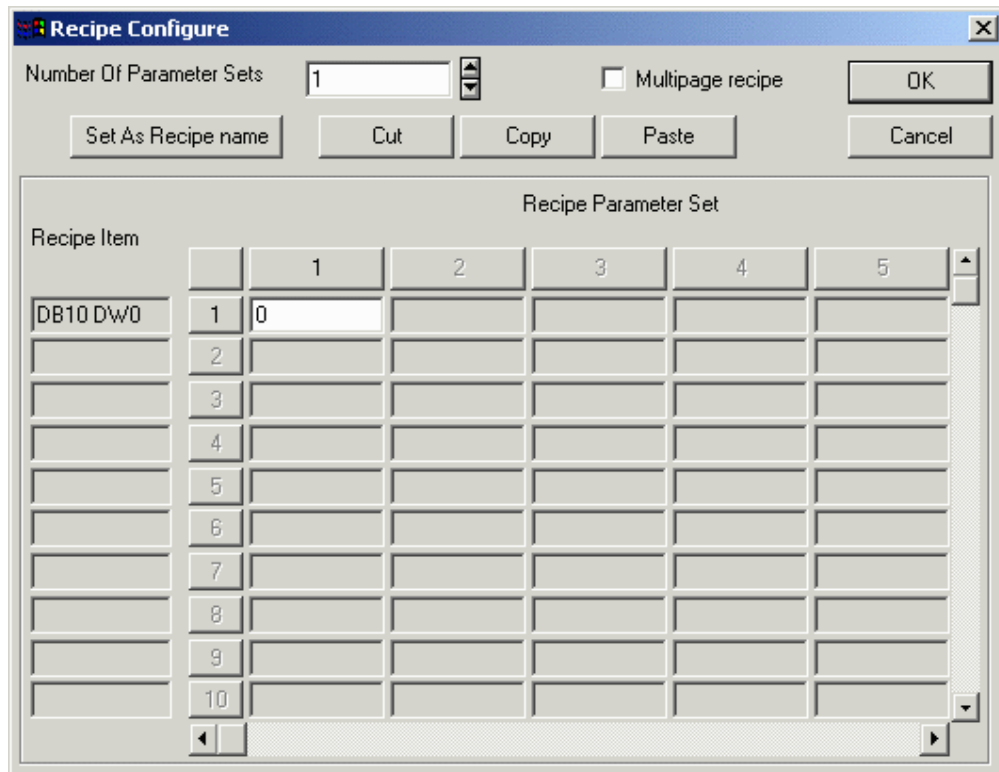

The Recipe Configuration dialog box lets you:

Specify the number of parameter sets for the recipe on the current page.

Specify default values for all recipe data items on the current page.

Note: Recipe data items must be defined on the current page before the Recipe Configuration dialog box can be activated. To do so, insert a Numeric/ASCII, Bargraph, or Message data field and select Recipe as the Reference.

#### 4.5.16 Number of Parameter Sets

Indicate the number of parameter sets. That number of columns is activated in the Recipe Parameter Set section.

#### 4.5.17 Multipage Recipe

Data which are logically part of a single recipe can be scattered over several project pages and still be selected, downloaded or uploaded with a single command. A recipe spanning several pages is called "Multipage Recipe".

Note: Multipage recipes are supported by UniOP firmware versions 4.20 and later.

#### 4.5.18 Set As Recipe Name

A Recipe Name should be defined for all of the pages containing recipes that are going to be handled using the Recipe Menu. It is also necessary for the pages that are referred to by Recipe Key field(s).

The Recipe Name is defined by adding a Numeric/ASCII data field of ASCII style on the page with recipes and filling the recipe data field values with a name for each parameter set.

After the recipe data field values have been inserted, click the row number button to select that row, then click the Set As Recipe Name button. An asterisk will appear next to the Recipe Item to indicate it has been selected as a Recipe Name.

Note: This ASCII field is not an internal variable in the panel memory. It needs to be addressed to a physical location in the PLC memory. The amount of memory required depends on the length of the ASCII string: one byte per character.

A Recipe Name definition example is provided.

#### 4.5.19 Cut

Cut deletes all Recipe Parameter Set entries beyond the position of the cursor.

#### 4.5.20 Copy

To copy, highlight a Recipe Parameter Set entry and click the Copy button. Clicking the Paste button pastes the copied entry into the box currently occupied by the cursor.

#### 4.5.21 Paste

Clicking the Paste button pastes the copied entry into the box currently occupied by the cursor.

#### 4.5.22 Recipe Values

#### 4.5.23 Recipe Values

The recipe values section is in the form of a spreadsheet. Each row is associated with a particular recipe data field. The controller address of the recipe data item is displayed at the far left hand side of the row, enabling you to tell which row is associated with which recipe data item.

Each column is associated with a particular parameter set of the recipe. Each parameter set is identified by a number. The first column corresponds to parameter set 1, the second column to parameter set 2, and so on.



The initial values for a particular parameter set can be fully specified by entering a value for each row in the column. The first column corresponds to parameter set 1, the second column to parameter set 2, and so on.

The number of columns activated in the spreadsheet corresponds to the number entered for Number of Parameter Sets.

#### **4.5.24 Recipe Item**

The number of rows activated on the spreadsheet corresponds to the number of recipe data fields defined on the page.

An asterisk next to a Recipe Item indicates that the item has been set as a recipe name.

#### **4.5.25 Recipe Parameter Set**

A parameter set is a specific block of data within a recipe. A recipe parameter set is created by assigning particular values to the recipe data fields on a page. With Designer, it is possible to create many different parameter sets within a single recipe. Depending upon the panel model, there can be up to 1024 parameter sets of a single recipe. Not only is a block of memory in the panel reserved for every recipe; separate blocks of memory are also reserved for each of the parameter sets contained within a particular recipe. All the parameter sets of a particular recipe always contain the same recipe data items but the values of these recipe data items vary between the different parameter sets.

These different recipe parameter sets can control different processes. One set may be used to configure the controller to control the production of 2 mm screws, another set may be used to configure the controller to control the production of 5 mm screws, and yet another to control the production of 7 mm screws. Each set of parameters is stored in a different parameter set within the same recipe.

Note: The default values entered for a particular recipe parameter set item are in the format that was specified in the Field Properties dialog box for that data item. For example, if a numerical format of hexadecimal was entered in the data Field Properties dialog box for a recipe data field, then all the values entered in the Recipe Configuration dialog box for that recipe data field would also be in hexadecimal. If you specify a numeric data format of hexadecimal (base 16) for a recipe data item, and then enter a value of 10 in the Recipe Configuration dialog box, the 10 will be interpreted as 10 hexadecimal. Likewise, if ASCII is the specified style, then the entry must be in ASCII text.

#### **4.5.26 Special Pages and Page Modes**

#### **4.5.27 Special Pages and Page Modes**

The items located within the Special Pages and Page Modes portion of the Page menu include

Data Entry Screen

Command Menu

System

Password

Direct Access

Direct Page Selection

Time & Date

Alarm Page

Event Page

Current Page Mode.

This allows you to place any combination of static text and touch cells on these pages. These items should be placed on the lower portions of the page, since these modes reserve some of the area contained in the upper portions of the page for display information.

Whenever the panel enters Password mode or Data Entry Mode, a default numeric keypad will appear on the screen. In all of the other modes, a row of default keys will appear that contains the arrow keys, an Enter key, and a Clear key.

Note: If you create a screen in any of the special page modes, the default keys for that mode will not be displayed.

#### **4.5.28 Data Entry Screen**

This screen will appear whenever you begin Data Entry Mode. When using a UniOP touchscreen panel, a numeric keypad will appear by default. If anything is placed on this screen, the default numeric keypad will not appear.

If this screen is modified, make sure that an Enter key is defined somewhere in this screen so that the panel user can always get out of Data Entry Mode.

#### **4.5.29 Command Menu**

This is the menu that appears when the panel user presses the Enter key on a touchscreen panel and holds it for a period of three to four seconds.

In the case of the keyless touch panel, this menu will appear whenever the user presses any area of the screen where there is no touch cell configured. You will not be able to write in the two topmost lines. The reason for this is that the panel reserves this area for the Command Menu itself.

#### **4.5.30 System**

This page will appear when the System option is selected in the Panel Command Menu.

This page allows the panel user to adjust the contrast or brightness (on some panels) and to see if there are good communications between the panel and the controller.

#### **4.5.31 Password**

This page is displayed when the panel user selects Passwords from the Panel Command Menu.

#### **4.5.32 Direct Access**

This page is in essence a snapshot of the controller's memory. This page will show all of the memory locations contained within the controller.

This menu can only be accessed when using a panel that contains a 16-line display or a 25-line display.

#### **4.5.33 Direct Page Selection**

In this menu, you can scroll through a list of page names and select the page to be displayed.

With this option, it is possible to see every page of a project file, even if the links to a particular page are broken.

#### **4.5.34 Time and Date**

This area lets you set the time and date on the panel. This information is used in the Alarm List, the Event List, and whenever you insert time fields or date fields into the project file.

#### **4.5.35 Alarm Page**

This page will appear on the panel whenever there is an active alarm present, providing the C2 bit in the RDA is not set.

If the C2 bit is set, the default alarm page will not appear.

#### **4.5.36 Event Page**

This page lists the previous 256 (some models up to 1024) events in sequential order on the panel. When more than 256 (1024) events have occurred, the older events will be removed in order to make room for the newer events.

#### **4.5.37 Current Page Mode**

This mode displays the page that you are currently on in the project file. This mode is the most often used when editing the project file.

## 4.6 Project Menu

### 4.6.1 Project Menu

This section provides information about the Project menu. The Project menu allows you to configure the panel, the controller, the network, and your project to work together seamlessly. Commands on the Project menu include:

Configure Controller

Panel Setup

Network Setup

Panel Controller Interface

Report on Panel Printer

Keyboard Macro Editor

Passwords

Alarms

Languages

Next Language

Configure Tag Dictionaries

Tag Validation

Trend Buffers

Memory Use

### 4.6.2 Configure Controller

### 4.6.3 Configure Controller

Designer supports many different controller manufacturer types.

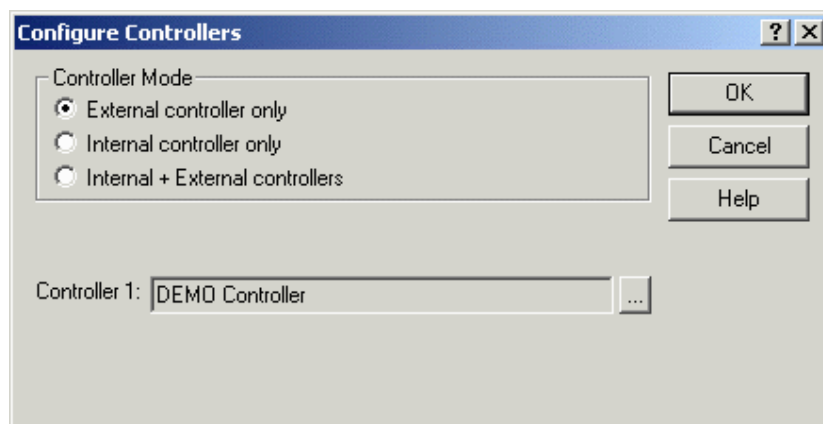

By selecting Configure Controller from the Project menu (or by clicking on the Configure Controller icon on the toolbar, or by pressing the Ctrl+Alt+P keys), you can access the Configure Controllers dialog box and select the controller mode and the brand of controller with which you will be working. You can also enable double protocol if desired.

Note: Designer uses the current controller setup and applies this setting to all subsequent projects until changed.

#### 4.6.4 Controller Mode

Indicate whether external, internal, or both internal and external controllers will be used.

Note: The appropriate choices for your system are activated during system initialization.

#### 4.6.5 Enable Double Protocol

A single UniOP panel can communicate with Controllers simultaneously using different communication protocols. When configuring the UniOP to communicate with controllers simultaneously using two different communication protocols (double protocol configuration), distinction must be made between the first communication driver (used to communicate using the first protocol) and the second communication driver (used to communicate using the second protocol).

The Configure Controllers dialog box contains a checkbox for Enable Double protocol. Checking this box lets you specify a second controller. Under the Controller 1 box another box will appear where you can specify Controller 2.

Designer will issue a warning if an illegal combination is chosen and will not close the dialog box until an allowable configuration is selected. If a configuration is specified in which a switch to new driver(s) was made, Designer will prompt the user to accept the change. If both drivers are changed, Designer will prompt twice.

If at least one of the drivers is a serial driver, the decision which driver will be set as the Controller 1, and which one as Controller 2 is important. Controller 1 will use the PLC port, and the Controller 2 will use the PC/Printer port. If one of drivers is using the current loop, it must become Controller 1 to ensure that it uses the PLC port because the current loop

capability is only implemented on this serial port. Also, as the PC/Printer and the PLC port connectors are of different genders, careful selection of Controller 1 and Controller 2 can make cabling easier and less expensive.

There is no major difference in configuring UniNET networks for single protocol applications and for double protocol applications. However, if one of either network type "Single Server, Multiple Clients" or "Multiple Server, Multiple Clients" is selected, all the UniOP network server nodes will inherit the current configuration of the project. In other words, if the project in which the network is being set up is currently configured for single protocol, all the UniOP node servers in the UniNET network will be configured to use only this protocol. If the project is configured for double protocol, all the UniOP node servers will be configured to use both protocols.

It is important to remember the following rules for serial drivers:

The first driver always communicates with the controllers over the PLC port

The second driver always communicates with the controllers over the PC/Printer port.

Of course, if any of the protocols is a non-serial protocol, its driver will use the AUX port instead.

There are a few hardware restrictions when two communication protocols are used:

If the communication driver is using both serial communication ports - the PLC and the PC/Printer port - it cannot be used in multi-protocol configurations.

If two communication drivers are both serial, there will be no ports left to connect the serial UniNET network. (You can still use the Ethernet-based UniNET, of course.)

Since only one communication module can be plugged into the panel, a combination of two communication drivers, each requiring such a module, cannot be supported.

As the Ethernet protocol is supported by a communication module, a combination of one Ethernet-based communication driver and a driver requiring any other communication module cannot be supported.

The internal controller module plugs into the same socket as the communication modules. Thus, if an internal controller is plugged into the panel, it not possible to plug in a communication module. Therefore, a communication driver requiring a custom communication module (including Ethernet-based) cannot be supported.

Note: Two Ethernet-based communication drivers can normally be used simultaneously because they will both communicate through the same Ethernet communication module. Ethernet-based UniNET can also be used in addition to one or two Ethernet-based communication drivers.

#### **4.6.6 Controller**

The currently selected controller(s) is listed. If this is not correct, click on the "... " button to activate the Select Controller dialog box.

#### 4.6.7 Select Controller

#### 4.6.8 Select Controller

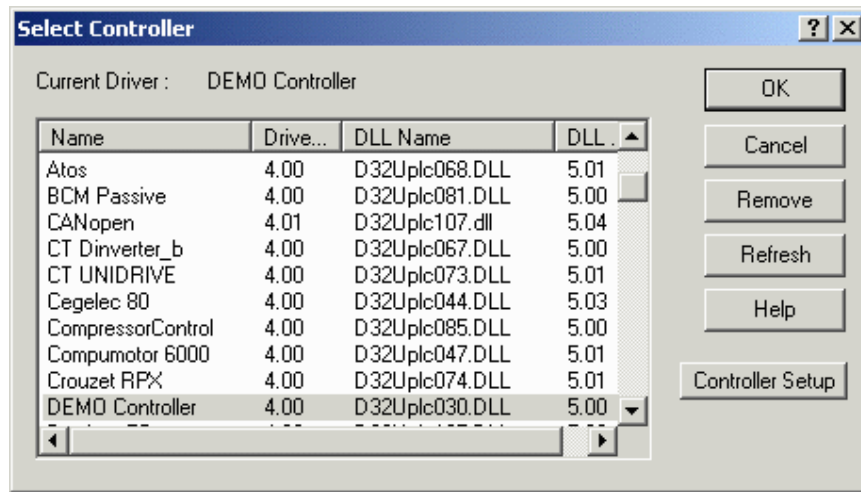

Pick the controller driver to be used from the list provided. Buttons within this box allow you to remove controllers from the list, refresh the list, or activate the Controller Setup dialog box.

#### 4.6.9 Remove

Clicking the Remove button removes the highlighted controller driver from the list.

#### 4.6.10 Refresh

Clicking the Refresh button refreshes the list of available controllers DLLs.

#### 4.6.11 Controller Setup

#### 4.6.12 Controller Setup

The entries and selections in the Controller Setup dialog box are customized for the particular type of controller selected. Indicate the particular controller model number, if necessary, and any other information necessary to customize the setup for your selected controller. This may include Slave ID, Access Multiple PLCs, PLC ID, etc.

The Access Multiple PLCs checkbox will allow the panel to exchange data with more than one controller. You must also enter the slave IDs of the different controllers from which the panel will be accessing data. This option is not available with all controllers.

Click the PLC/Driver Comm button to configure communication parameters for this particular controller.

### **4.6.13 Communications Parameters Setup**

#### **4.6.14 Communications Parameters Setup**

The communication parameters for any particular controller are set automatically when the selection is made.

However, if there is a need to change the default settings, press the PLC/Driver Comm button in the Controller Setup dialog box. This will bring up the Communications Parameters Setup dialog box where you can configure the baud rate, parity, data bits, and stop bits for communication.

#### **4.6.15 Baud Rate**

This option specifies the baud rate to be used in communication between the panel and the controller.

#### **4.6.16 Parity**

Specifies the parity to be used in communication between the panel and the controller.

#### **4.6.17 Data Bits**

Specifies the number of data bits to be used in communication.

#### **4.6.18 Stop Bits**

Specifies the number of stop bits to be used in communication between the panel and the controller.

#### **4.6.19 Panel Setup**

#### **4.6.20 Panel Setup**

Panels come in many different types with different capabilities. The Panel Setup dialog box lets you specify the appropriate panel type and the amount of target memory in the target panel.



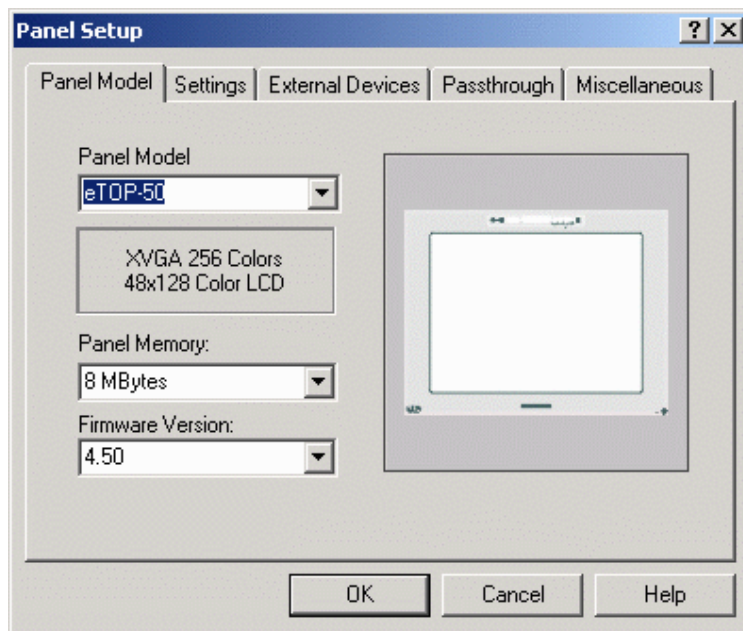

Panel selection can be made manually or it can be obtained directly from the UniOP panel itself by using the Get Panel Resources command. This command retrieves the information directly from the UniOP panel that is connected to the PC.

To access the Panel Setup dialog box, select Panel Setup from the Project menu or click the Panel Setup icon on the toolbar. The tabs in the Panel Setup dialog box include:

Panel Model,

Settings,

External Devices,

Passthrough, and

Miscellaneous.

#### 4.6.21 Recognition of Old Panel Models

Designer recognizes a model code that is inside the panel or inside the project file.

When using an older panel or an older project file, the model code may not be found. In this case, Designer tries to "guess" the panel model that was initially used by comparing the panel capability information stored inside the panel device or inside the project file with the panel capabilities that are defined inside the panel database within Designer.

It is possible that Designer will find more than one panel that fits the available capability description. In this case, Designer will show a warning message to advise you to manually enter the model in the Panel Setup dialog box.

When Designer cannot determine the UniOP model associated with a project file, the GENERIC panel model will be selected. In this mode, all of the available panel capabilities will be enabled.

It is also possible to manually select the GENERIC panel model. This is useful if you have a new UniOP panel that has not been defined within the Designer panel database.

#### 4.6.22 Panel Model

#### 4.6.23 Panel Model

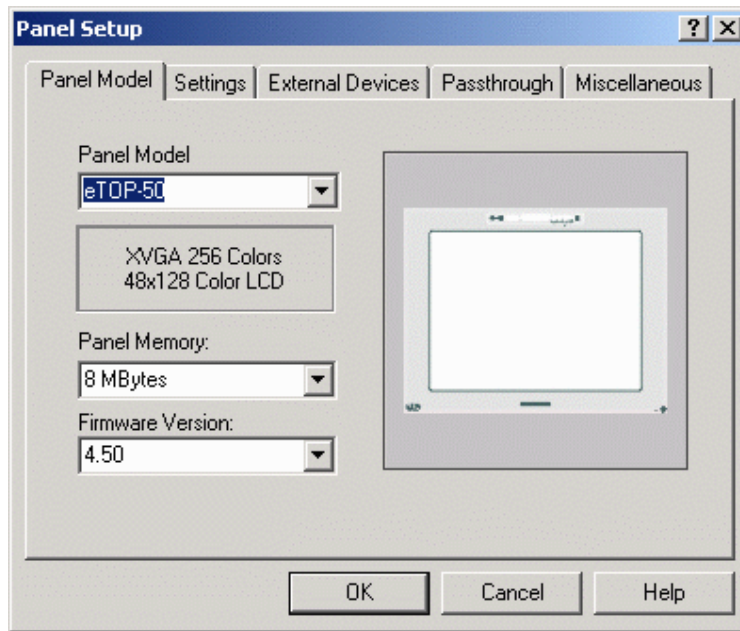

Use the Panel Model tab to directly select the UniOP model being used. On the right side of the dialog box a preview picture of the currently selected UniOP panel is displayed. You can select the panel model, the panel memory, and the firmware version.

#### 4.6.24 Panel Model

To choose a new panel model, choose a panel from the drop-down list under Panel Model. The page editor workspace will change in order to reflect the available screen area on the selected model.

Note: The panel model may be changed at any time during development. However, be aware that some restrictions apply regarding the screen area. You can change the display from a small screen size to a larger screen size without affecting the contents of the project. However, changing from a large screen size to a smaller screen size may delete some data fields if they are beyond the new screen boundary. If this occurs, you will be given the chance to cancel the operation before any fields are deleted.

If you are unsure of the UniOP model being used, or if you have a new UniOP panel that has not been defined within the Designer panel database, select the GENERIC panel model. In this mode, all of the available panel capabilities will be enabled.

Note: When using the GENERIC selection, you must specify all the panel definitions.

#### 4.6.25 Panel Memory

Appropriate memory choices for the specified Panel Model are listed. Select the amount of memory available in the panel.

#### 4.6.26 Firmware Version

Choose the appropriate version of the panel firmware. If you have a panel with a newer firmware version that is not yet defined inside the Designer package, please select the highest Designer firmware version. Selecting the All firmware version will enable only the basic panel capabilities that are supported with all panel firmware versions.

#### 4.6.27 Preview

The Preview area shows a typical panel screen for the selected Panel Model.

#### 4.6.28 Settings

#### 4.6.29 Settings

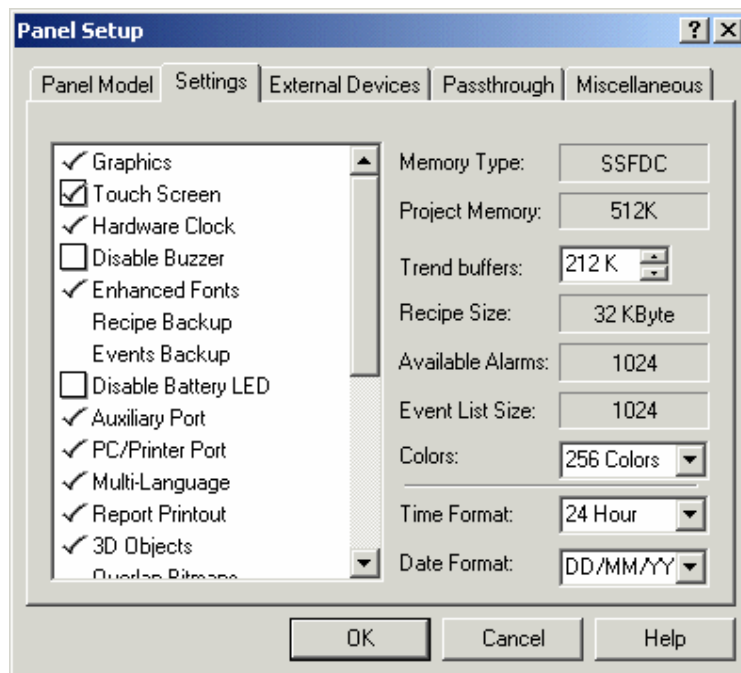

The Settings tab shows the capabilities of the selected model. Some capabilities are fixed and cannot be changed by the user. Others have a checkbox or a list box and can be modified. These settings will vary depending upon the panel model specified.

The Settings tab lists various information about the project, such as the memory type, the amount of project memory, the trend buffer memory setting, the recipe size, the available alarms, the event size list, and the number of colors. This tab also allows you to specify the time and date format for Time and Date data items.

### **4.6.30 Settings List**

#### **4.6.31 Settings List**

The left side of the Settings index tab lists the capabilities supported by the selected panel. You can modify these selections when they are supported by the currently selected UniOP model.

Commonly selectable items include:

Buzzer,

Disable Battery LED,

Events Backup,

Firmware Download,

Recipe Backup,

Touch Screen

Update PLC References

Extended Data Entry

#### **4.6.32 Buzzer**

Enables/Disables the panel buzzer (when available)

#### **4.6.33 Disable Battery LED**

Enables/Disables the battery LED indicator.

#### **4.6.34 Events Backup**

Enables/Disables the events log backup inside the internal FLASH memory. This is used by the Recipes and Events Backup macro.

#### **4.6.35 Firmware Download**

New panels that contain the T2000 board have the ability to manage firmware downloads from within Designer (without using the UniDataExchange utility). This flag will be checked for panels that support this firmware download feature.

Firmware Download may be enabled manually from the Settings index tab within the Panel Setup dialog box for certain situations. Manual settings are necessary when a real panel is not physically connected to the PC and a Get Panel Resources command cannot be executed.

#### **4.6.36 Recipe Backup**

Enables/Disables the recipe backup inside the internal FLASH memory. This is used by the Recipes and Events Backup macro.

#### **4.6.37 Touch Screen**

When touch screen is not enabled, the display window can be scrolled down to line 32.

When touch screen is enabled, the display window has the same size as the panel display and cannot be scrolled.

#### **4.6.38 Update PLC References**

When the UniOP panel supports referencing the data field min/max range settings to a memory location in the controller (PLC Reference), this field determines the field update rules. If this field is checked the PLC Reference will be updated continuously, otherwise they will be updated only when the page is activated.

#### **4.6.39 Memory Type**

Can be FLASH for UniOP models with internal memory only or SSFDC for UniOP models with a removable SSFDC memory card.

#### **4.6.40 Project Memory**

Internal memory reserved for project file.

#### **4.6.41 Trend Buffers.**

Memory assigned to trend buffer can be set here. The trend buffer size parameter can be increased /decreased with step of 32k.

#### **4.6.42 Recipe Size**

Internal memory reserved for recipe data.

#### **4.6.43 Available Alarms**

Number of available alarms.

#### **4.6.44 Event List Size**

Number of available events.

#### **4.6.45 Colors**

Number of supported colors. This list box is enabled only for panels that support 256 colors. For those models that do not support 256 colors, a fixed value is shown.

#### **4.6.46 Time Format**

Specify whether the panel will display time data fields in a 24-hour format (for example 20:10) or a 12-hour format (for example 10:10pm).

#### **4.6.47 Date Format**

Specify whether the panel will display date data fields in a month/day/year format or a day/month/year format.

#### 4.6.48 External Devices

#### 4.6.49 External Devices tab

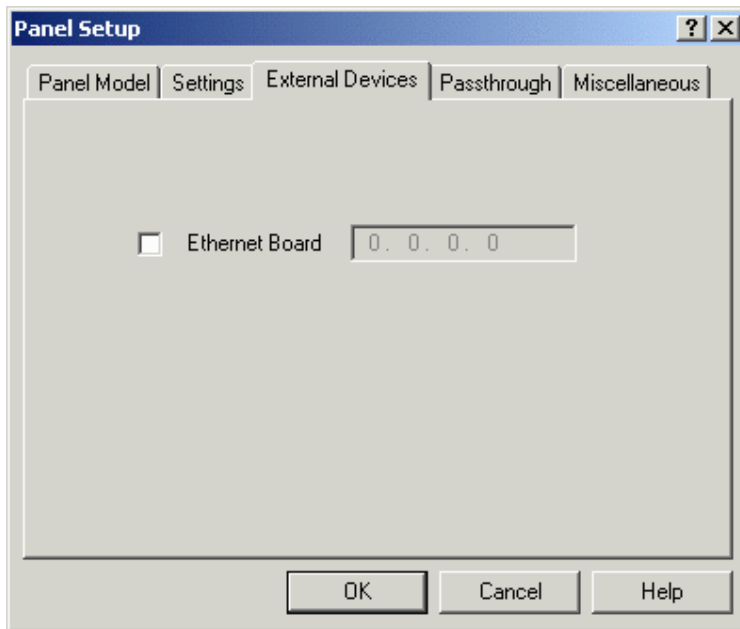

Under Panel Setup, the options available under the External Devices index tab can be used to specify the presence of the TCM10 communication module (Ethernet Board) and assign an IP address to it.

For firmware 5.00 and above the External Devices tab will have an additional property button as shown in the below dialog

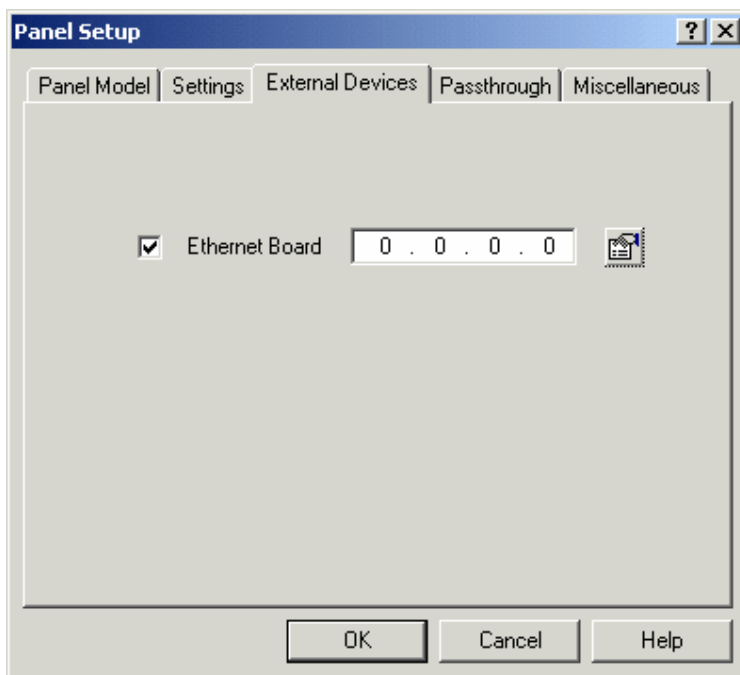

On clicking the property button Ethernet Settings dialog will be displayed as shown below

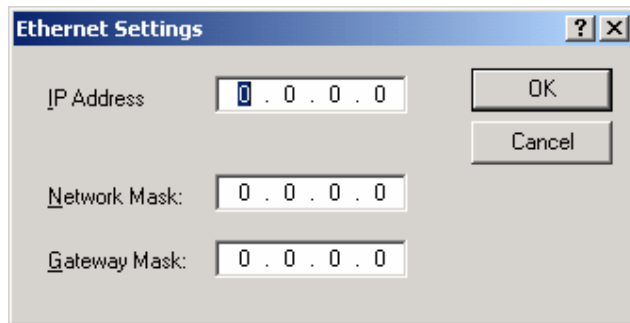

The above dialog box allows to specify network parameters such as Network Mask and Gateway Mask.

#### **4.6.50 Ethernet Board**

Using the (optional) external TCM10, the UniOP can be connected to an Ethernet UDP/IP network. Check the Ethernet Board box if there is such an Ethernet board associated with the panel to enable network support.

#### **4.6.51 IP Address**

Enter the board's IP address in the entry box. The IP address used has to be chosen according to the overall Ethernet configuration.

This address will be disabled when the Network Setup configuration is used. In that case the panel node IP Address and the protocol must be selected from the Network Configuration dialog box.



## 4.6.52 Passthrough

### 4.6.53 Passthrough

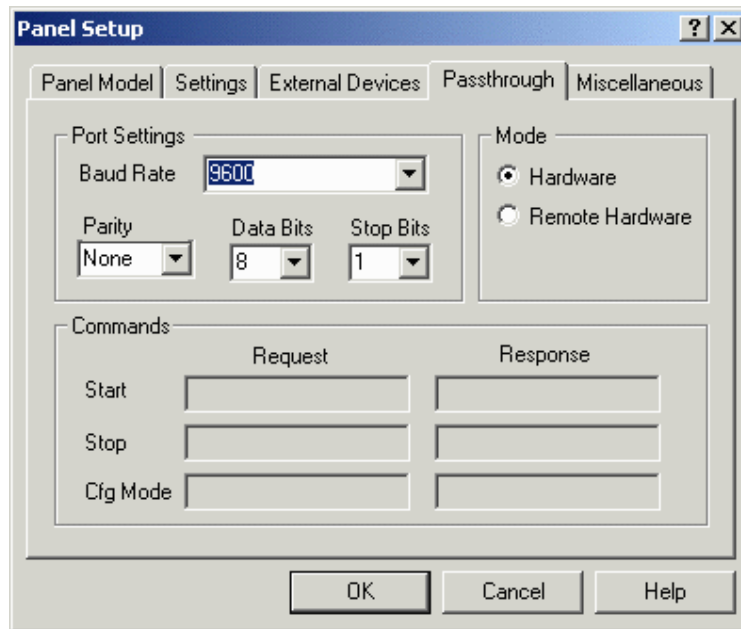

The Passthrough tab lets you configure the panel passthrough feature parameters. This lets you remotely put a UniOP panel into either Configuration Mode or Operation Mode. In this manner, you can remotely upload or download a project file, start the panel, or use passthrough mode to access the programming port on the PLC and issue commands.

The communication parameters for any particular controller are set automatically when the selection is made. However, if there is a need to change the default settings, you can do so by changing the port settings under the Passthrough tab in the Panel Setup dialog box.

Note: The UniOP panel must contain firmware version 4.10 or later to use this feature.

Note: The PC/Printer port cannot be used for printing when passthrough is configured.

### 4.6.54 Port Settings

### 4.6.55 Port Settings

Different models of controllers require different parameters in order to communicate properly with the operator interface panel.

Configure the passthrough serial line parameters. If the optimum settings for baud rate, parity, data bits and stop bits to be used for communication between the target panel and the controller differ from those shown under the Port Settings, you can change the settings.

Note: All UniOP panels are capable of communicating with a PC at a speed of at least 9600 baud. Some panels will communicate at speeds of 19,200 baud and 38,400 baud. With

some Pentium-based computers, a speed of 19200 baud may prove to work more efficiently than 38,400 baud.

#### **4.6.56 Baud Rate**

This option specifies the baud rate to be used in communication between the target panel and Designer.

#### **4.6.57 Parity**

Specifies the parity to be used in communication between the target panel and Designer.

#### **4.6.58 Data Bits**

Specifies the number of data bits to be used in communication.

#### **4.6.59 Stop Bits**

Specifies the number of stop bits to be used in communication between the target panel and Designer.

#### **4.6.60 Mode**

##### **4.6.61 Mode**

Define the passthrough activation mode. The available choices are Hardware or Remote Hardware.

##### **4.6.62 Hardware**

Panel passthrough mode can be activated locally by the panel by using a macro or a mailbox command.

##### **4.6.63 Remote Hardware**

Panel passthrough mode can be activated remotely by sending a string command through the serial line. To configure Designer for remote passthrough via a modem, select Remote Hardware passthrough from the Passthrough tab under Panel Setup.

Note: Remote Hardware passthrough should be selected only if passthrough mode is to be used locally and not via a modem.

When Remote Hardware passthrough is selected in Panel Setup, the Remote passthrough entry becomes available in the Transfers menu. This entry lets you select one of three remote passthrough commands: Configuration Mode, Start and Stop.

## **4.6.64 Commands**

### **4.6.65 Commands**

In this section, you can define command strings to manage the passthrough feature. Enter the commands to put the panel into Configuration Mode, to send the start command and to send the stop command in the Request boxes. Likewise, enter the responses to be received back from the panel in the Response boxes.

Note: The Commands section is only activated if Remote Hardware is selected as the Mode.

### **4.6.66 Start**

Command and response string to be used to send the start command.

### **4.6.67 Stop**

Command and response string to be used to send the stop command.

### **4.6.68 Cfg Mode**

Command and response string to put panel in configuration mode.

## 4.6.69 Miscellaneous

## 4.6.70 Miscellaneous

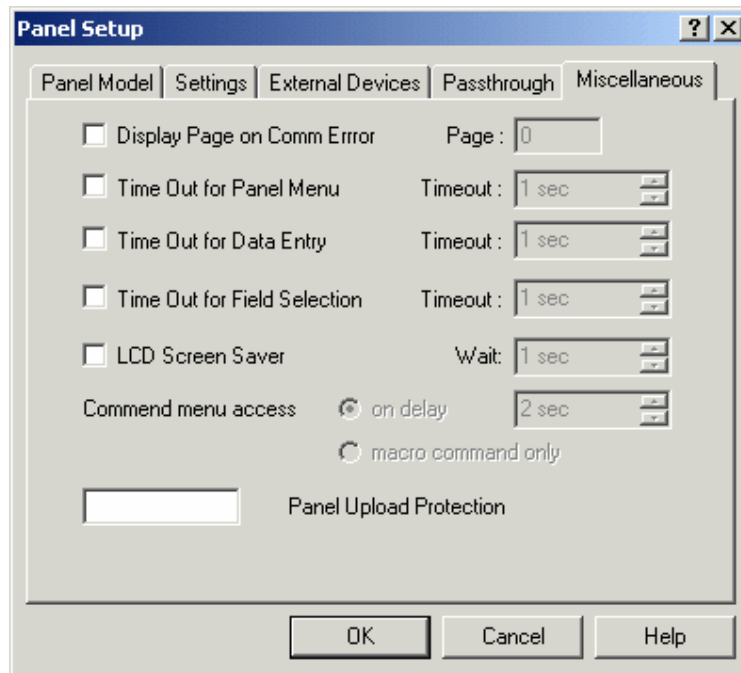

The Miscellaneous tab lets you configure several different panel parameters. Selecting any of the checkboxes enables the entry boxes associated with those selections. These selections include:

Display Page on Comm Error

Time Out for Panel Menu

Time Out for Data Entry

Time Out for Field Selection

LCD Screen Saver

Panel Upload Protection

Command Menu Access

## 4.6.71 Display Page on Communication Error

This lets you specify a page for the panel to go to whenever a communication error is reported or communications between the panel and PLC are lost.

#### **4.6.72 Time Out for Panel Menu**

The period of time the panel will wait for a keystroke before returning to normal operation. This lets you return to Operation Mode from the Panel Command Menu if there are no keys pressed for the specified amount of time.

#### **4.6.73 Time Out for Data Entry**

The period of time the panel will wait for a keystroke before returning to normal operation. This lets you return to Operation Mode from the Data Entry screen if there are no keys pressed for the specified amount of time.

#### **4.6.74 Time Out for Field Selection**

The time period the panel will wait for a field selection to be made before returning to normal operation. This lets you return to Operation Mode from Data Entry if there are no fields selected within the specified amount of time.

#### **4.6.75 LCD Screen Saver**

This option lets you turn off the back-lighting on an LCD panel when no keys or touch cells have been pressed for a certain amount of time.

#### **4.6.76 Panel Upload Protection**

This feature lets you password protect the project file so that unauthorized uploads cannot occur. You can enter a case-sensitive password of up to eight characters. When this field contains a value, the defined password will be requested in order to upload the project file from the panel.

Once this password is specified, every time you attempt to upload the project from the panel onto your computer, Designer will ask you to enter the password. If the password that you enter matches the one that was defined in the project file, the upload operation will be performed properly.

However, if you enter a password that doesn't match the one that was specified in the project file, the panel will not start the upload process.

Note: Your panel must contain firmware version 4.10 or later to use this feature.

#### **4.6.77 Command Menu Access**

The time out for access to Command Menu is programmable. This feature requires firmware 5.02 and above. Access to Command Menu can be disabled and manually handled by means of a macro command.

## 4.6.78 Network Setup

### 4.6.79 Network Setup

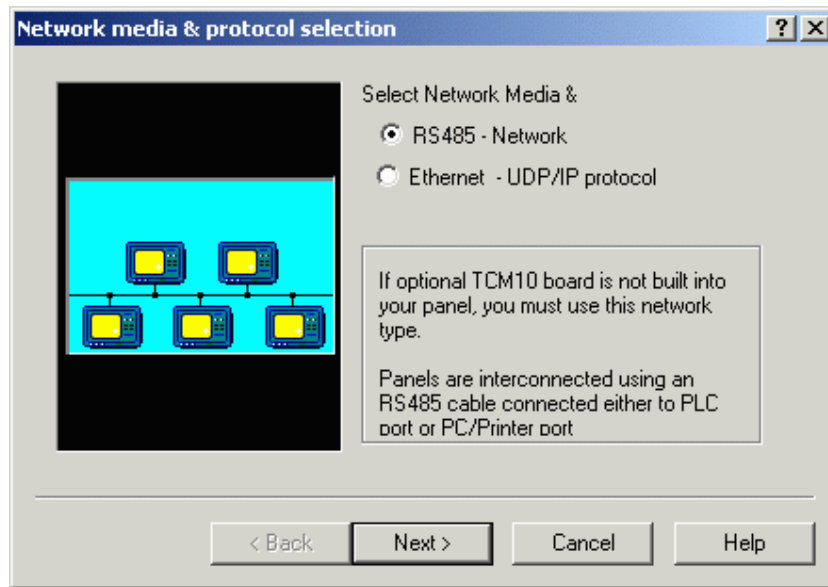

The UniNET Network is a feature of the operator panels that enables them to be connected together and to communicate with each other. It is possible to connect two or more panels (the maximum number is 32) with either a Serial (RS485) connection or an Ethernet connection. This offers the ability to display on one panel either the data from the controller attached to the panel itself, or data from other controllers attached to other panels on the network.

Information about UniNET networks, clients and servers, connecting operator panels to the network, advanced network programming, and network setup is available.

An example is provided that describes the steps required to set up a UniNET network composed of a single server operator panel connected to a controller and two client operator panels which will access the controller data via the server through the network services.

If a network is not defined for a project, selecting Network Setup from the Project menu (or by clicking the Network Setup icon on the toolbar) brings up the Network media & protocol selection dialog box. If a network type is already defined for a project, selecting Network Setup takes you directly to the Network Configuration dialog box.

## 4.6.80 Network Media and Protocol

### 4.6.81 Network Protocol

The first step in configuring the network is selecting the network type. The Designer software supports two types of UniNET network: an RS485 network, or an Ethernet-based network.

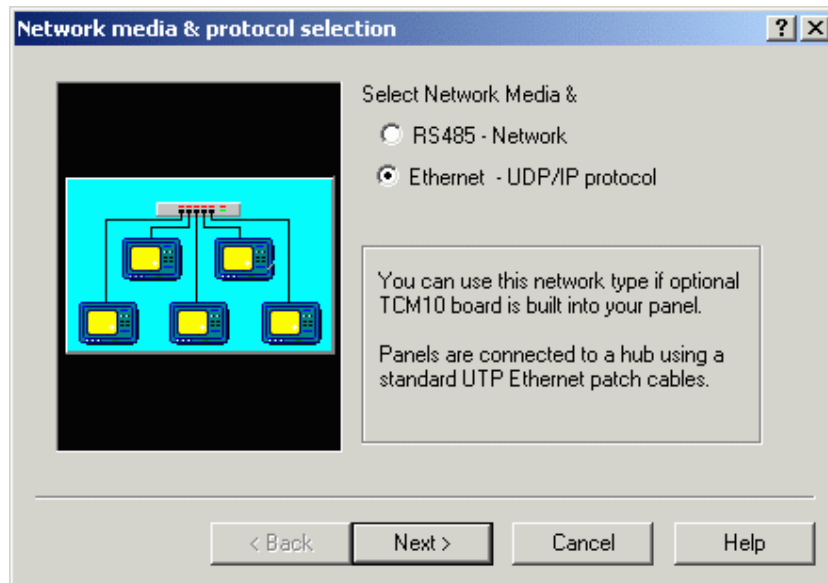
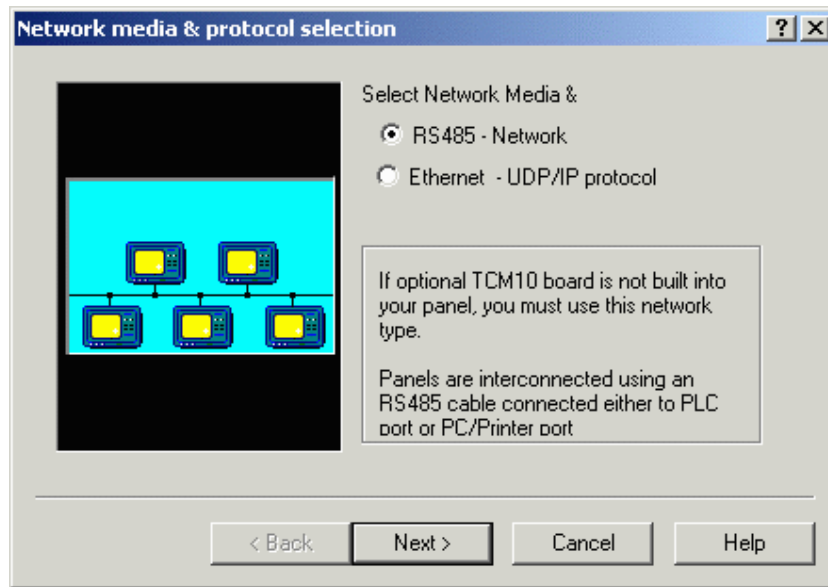

Select the type of network, click the Next> button, and the Network Selection dialog box appears.

#### 4.6.82 Ethernet

The networking capabilities of the UniOP operator panels include connections to Ethernet-based networks. Ethernet is becoming a popular communication support for cell-level industrial controllers. There is no standard set in the industry for the application level protocol, but there are several non-compatible protocols. As the only common point, they are all based on the TCP/IP or UDP/IP protocols.

There are two main classes of applications where Ethernet networking capabilities can be successfully used:

Direct connection to Ethernet-based PLC networks

Extending the UniNET network

Note: UniOP panels can be successfully connected to an Ethernet-based PLC network only if the specific application layer protocol has been implemented.

The UniOP UniNET network is able to use Ethernet, when available, as the communication media.

The advantages of this type of network, as compared to conventional UniNET technology, are the ability to use existing network cables and a more effective solution for connecting a computer to the UniNET network.

Information is available on the TCM10 board (required to connect a UniOP panel to an Ethernet network), the UniNet OPC Server, and configuring Ethernet networks.

## 4.6.83 RS485

This network type must be used if the optional TCM10 board is not built into the panel. In this type of network, panels are interconnected using simple RS-485 cables.

Please refer to the Connecting Panels to a RS485 Network section to see how to build your RS485 UniNET Network.

## 4.6.84 Network Selection

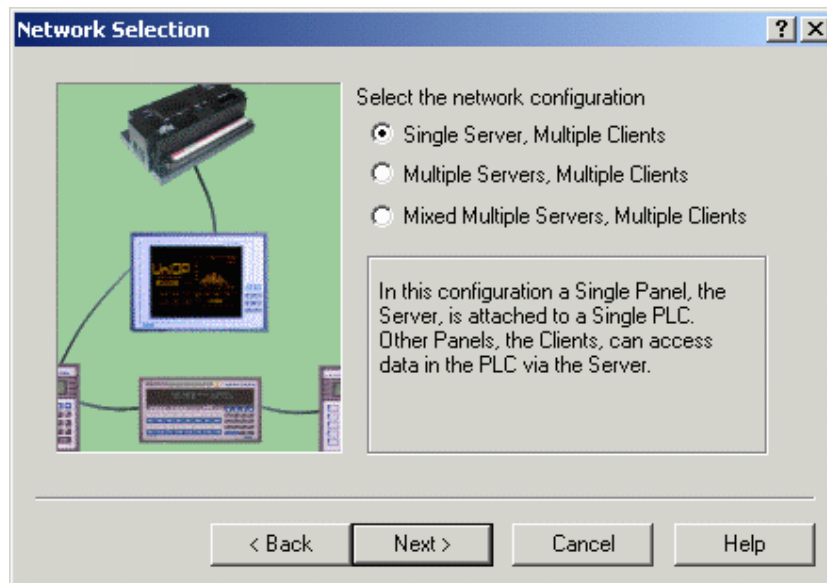

You may choose between the three network types:



Single Server, Multiple Clients

Multiple Servers, Multiple Clients (same controller types)

Mixed Multiple Servers, Multiple Clients (different controller types)

The parameters for the network are automatically configured if it is selected to be of either the Single Server, Multiple Client type or of the Multiple Server, Multiple Client type. However, Designer lets you make modifications to the network parameters by clicking on the Configure button.

If you chose Mixed Multiple Servers, Multiple Clients, you must specify all of the configuration parameters for the network by clicking on the Configure button.

#### 4.6.85 Network Configuration

#### 4.6.86 Network Configuration

The parameters for the network are automatically configured if it is selected to be of either the Single Server, Multiple Client type or of the Multiple Server, Multiple Client type. However, Designer lets you make modifications to the network parameters by using the Network Configuration dialog box.

If you chose Mixed Multiple Servers, Multiple Clients, you must specify all of the configuration parameters for the network.

The Network Configuration dialog box may be accessed by clicking on the Configure button in the Network Selection process, or by selecting Network Setup from the Project menu (or clicking on the Network Setup icon on the toolbar) after a network has been configured for a project.

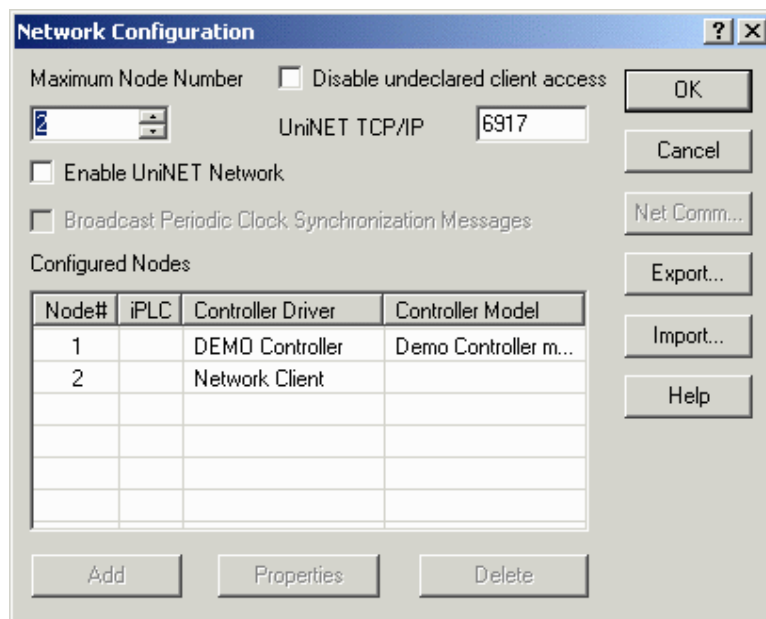

When the Mixed Multiple Servers, Multiple Clients option is selected, you must click on the Configure button to access the Network Configuration dialog box and explicitly enter all of the parameters for the required network.

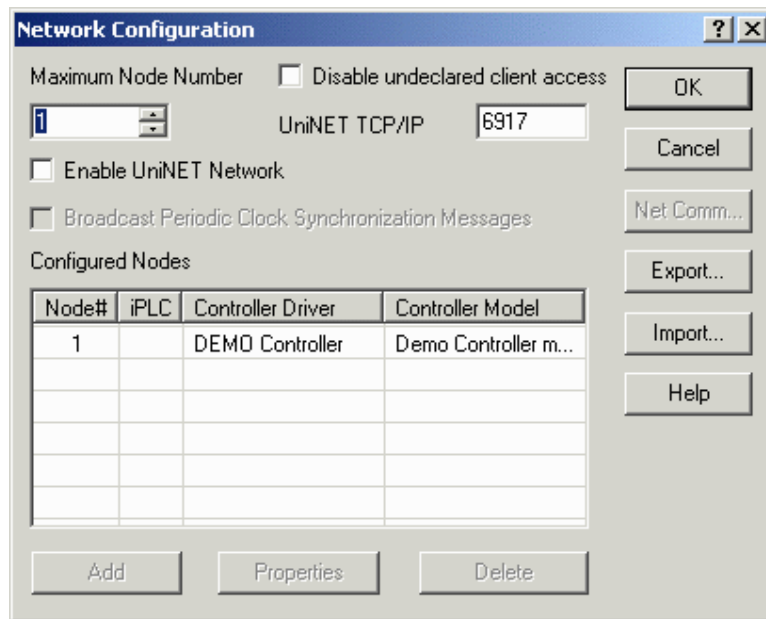

The Network Configuration dialog box contains a number of commands, including: Maximum Node Number, Enable UniNET Network, Broadcast Periodic Clock Synchronization Messages, a list of the Configured Nodes, an Add button, a Delete button, a Properties button, a Net Comm button, an Export button, and an Import button.

#### 4.6.87 Maximum Node Number

The Maximum Node Number is the node number of the highest node that will be allowed to receive the network token. Nodes that have a node number higher than this value will not be able to communicate over the network. The Maximum Node Number should be set as low as possible to minimize the amount of time that will be required for token rotation.

#### 4.6.88 Disable Undeclared Client Access

When checked, this box specifies that partners of the UniNET network cannot be accessed by a client not expressly declared to be a member of the network.

Note: this field is only available when the UNiNET Network employs Ethernet Connectivity.

Note: A general configuration where the UniOP UniNET node is set to 1 and several servers are configured with a different IP address is allowed if it corresponds to several UniNET networks, each one composed of only one panel working as a server. These UniNET networks are part of the same Ethernet network; the UniOP servers are independent from each other and the use of a similar layout is useful when a UniNET client running on a PC may be required to collect data coming from several different controllers.

#### 4.6.89 UniNET TCPIP

Represents the port number from which the UniNET protocol services respond. The default value is normally correct. However, it may be changed in case the default port is already assigned to another service.

Note: this field is only available when the UNiNET Network employs Ethernet Connectivity.

#### 4.6.90 Enable UniNET Network

Click the Enable UniNET Network checkbox to activate (enable) the configured network configuration. If the UniNET network is enabled then the panel to which the project file will be downloaded will act as part of the network. If it is disabled the panel will function as a normal, non-networked panel. If the UniNET network is enabled then one of the already configured nodes can be selected, thus assigning the node number for the current project file and for the panel to which the project file will be downloaded.

A checkmark appears next to a node number when the UniNET Network is enabled. This is used to determine which UniNET node is assigned to the current project. Right mouse click on the name and then Set as Current Panel node.

#### 4.6.91 Broadcast Periodic Clock

If the UniNET network is enabled then you can specify whether the panel is to broadcast periodic real time clock synchronization messages across the network. The purpose of these messages is to synchronize the clocks in the different panels attached to the UniNET network.

If the check box Broadcast Periodic Clock Synchronization Messages is checked then the panel will broadcast a clock synchronization message across the network every 60 minutes. If the check box is not checked then the periodic clock synchronization messages will not be broadcast by the panel.

The best way to ensure clock synchronization across the UniNET network is to configure only one panel as the broadcaster of the periodic clock synchronization messages.

Note: The check box Broadcast Periodic Clock Synchronization Messages only controls the periodic clock synchronization broadcasts. However, every panel in the UniNET network, regardless of the setting of this check box, will always broadcast a one-off clock synchronization message to the network whenever the time and date menu is exited on the panel and whenever the panel receives a mailbox command instructing it to perform a clock synchronization.

#### 4.6.92 Net Comm

Pressing the Net Comm button displays the Communication Parameters Setup dialog box where you can configure the communication parameters for the network. To obtain the best results the highest baud rate possible should be used.

Note: Network communications parameters need to be set for an RS-485 network only. The Net Comm button is not activated for Ethernet networks.

#### **4.6.93 Export**

Click on the Export button to save the existing network configuration to a file. Network configuration files have the extension .NET.

#### **4.6.94 Import**

Any network configuration may be saved for later use or for sharing between multiple project files designed for the same network. Click on the Import button to load an existing configuration. Network configuration files have the extension .NET.

#### **4.6.95 Configured Nodes**

##### **4.6.96 Configured Nodes**

This is list of the already configured network nodes. Each node in the list is described by its node number, controller driver and model.

##### **4.6.97 Node Number**

The node number of the node being selected for configuration. It must be a number greater than 0 and smaller or equal to the Maximum Node Number.

##### **4.6.98 Controller Driver**

During the configuration process all the client panels must be assigned the Network Client protocol, and all the server panels must be assigned the protocol of the controller they are directly attached to.

##### **4.6.99 Controller Model**

The controller panel model.

#### 4.6.100 Add

Click this button to add a new node to the list of configured nodes, using the Add/Edit Panel Node dialog box. To activate the Add button, change the Maximum Node Number.

#### 4.6.101 Properties

#### 4.6.102 Properties

To modify an existing node you must first select the required node from the list of already configured nodes.

Click Properties from the Network Configuration dialog box to view the network properties associated with that node as listed in the Add/Edit Panel Node dialog box, or click Add to add another node to the list.

The screenshot shows a dialog box titled "Add Panel Node". It contains the following fields and controls:

- Panel Node:** A text box containing the number "3".
- IP Address:** A text box containing "0 . 0 . 0 . 0".
- Printout Node:** A text box containing the number "3".
- Num Comm Retries:** A spinner box set to "1".
- Comm Time Out:** A spinner box set to "100 msec".
- Enable Double protocol:** An unchecked checkbox.
- Controller 1:** A text box with an ellipsis button to its right.
- Buttons:** "OK" and "Cancel" buttons are located on the right side of the dialog.

A number of items can be specified in the Add/Edit Panel Node dialog box. These include the Panel Node, the IP Address, the Printout Node, the Number of Communication Retries, the Communication Time Out setting, whether to Enable Double protocol, and the controller setting.

#### 4.6.103 Panel Node

Represents the UniNET node of the panel. Ethernet networks are still based on the UniNET application layer protocol.

More than one panel can have the same panel node. The configuration corresponds in this case to several different UniNET networks that cohabit on the same Ethernet line. Each time two partners are configured with the same UniNET node and they reside together on the same Ethernet network, they are conceptually part of distinct UniNET networks. This concept allows users to put more than 32 UniNET nodes on the same UniNET Ethernet based network.

Note: A general configuration where the UniOP UniNET node is set to 1 and several servers are configured with different IP address is allowed if it corresponds to several UniNET networks, each one composed of only one panel working as server. These UniNET networks are part of the same Ethernet network; the UniOP servers are independent from each other and the use of a similar layout is useful when a UniNET client running on a PC may be required to collect data coming from several different controllers.

#### **4.6.104 IP Address (Ethernet network only)**

Represents the IP address assigned to the UniNET node. This must be unique in the Ethernet network.

#### **4.6.105 Comm Port (for Network RS-485 network only)**

Specify the port that the network will use for communication.

#### **4.6.106 Printout Node**

Node number of the node to be used for the network printout function.

#### **4.6.107 Num Comm Retries**

Number of times a network message is retried in case of communication errors.

#### **4.6.108 Comm Time Out**

Value of the time out interval used in the network communication.

#### **4.6.109 Enable Double Protocol**

A single UniOP panel can communicate with Controllers simultaneously using different communication protocols. When configuring the UniOP to communicate with controllers simultaneously using two different communication protocols (double protocol configuration), distinction must be made between the first communication driver (used to communicate using the first protocol) and the second communication driver (used to communicate using the second protocol).

The Configure Controllers dialog box contains a checkbox for Enable Double protocol. Checking this box lets you specify a second controller. Under the Controller 1 box another box will appear where you can specify Controller 2.

Designer will issue a warning if an illegal combination is chosen and will not close the dialog box until an allowable configuration is selected. If a configuration is specified in which a

switch to new driver(s) was made, Designer will prompt the user to accept the change. If both drivers are changed, Designer will prompt twice.

If at least one of the drivers is a serial driver, the decision which driver will be set as the Controller 1, and which one as Controller 2 is important. Controller 1 will use the PLC port, and the Controller 2 will use the PC/Printer port. If one of drivers is using the current loop, it must become Controller 1 to ensure that it uses the PLC port because the current loop capability is only implemented on this serial port. Also, as the PC/Printer and the PLC port connectors are of different genders, careful selection of Controller 1 and Controller 2 can make cabling easier and less expensive.

There is no major difference in configuring UniNET networks for single protocol applications and for double protocol applications. However, if one of either network type "Single Server, Multiple Clients" or "Multiple Server, Multiple Clients" is selected, all the UniOP network server nodes will inherit the current configuration of the project. In other words, if the project in which the network is being set up is currently configured for single protocol, all the UniOP node servers in the UniNET network will be configured to use only this protocol. If the project is configured for double protocol, all the UniOP node servers will be configured to use both protocols.

It is important to remember the following rules for serial drivers:

The first driver always communicates with the controllers over the PLC port

The second driver always communicates with the controllers over the PC/Printer port.

Of course, if any of the protocols is a non-serial protocol, its driver will use the AUX port instead.

There are a few hardware restrictions when two communication protocols are used:

If the communication driver is using both serial communication ports - the PLC and the PC/Printer port - it cannot be used in multi-protocol configurations.

If two communication drivers are both serial, there will be no ports left to connect the serial UniNET network. (You can still use the Ethernet-based UniNET, of course.)

Since only one communication module can be plugged into the panel, a combination of two communication drivers, each requiring such a module, cannot be supported.

As the Ethernet protocol is supported by a communication module, a combination of one Ethernet-based communication driver and a driver requiring any other communication module cannot be supported.

The internal controller module plugs into the same socket as the communication modules. Thus, if an internal controller is plugged into the panel, it not possible to plug in a communication module. Therefore, a communication driver requiring a custom communication module (including Ethernet-based) cannot be supported.

Note: Two Ethernet-based communication drivers can normally be used simultaneously because they will both communicate through the same Ethernet communication module. Ethernet-based UniNET can also be used in addition to one or two Ethernet-based communication drivers.

## 4.6.110 Controller

The currently selected controller(s) is listed. If this is not correct, click on the "..." button to activate the Select Controller dialog box.

## 4.6.111 Delete

Click the Delete button to remove the currently selected node from the list of configured nodes.

## 4.6.112 Panel Controller Interface

## 4.6.113 Panel Controller Interface

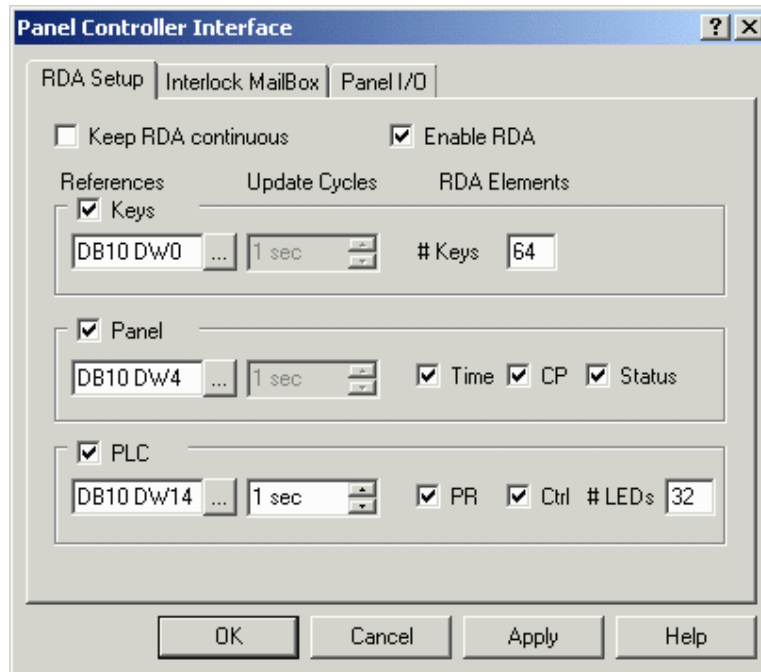

The Panel Controller Interface allows you to set parameters for RDA Setup, the Interlock Mailbox, Panel I/O.



#### 4.6.114 RDA Setup

#### 4.6.115 RDA Setup

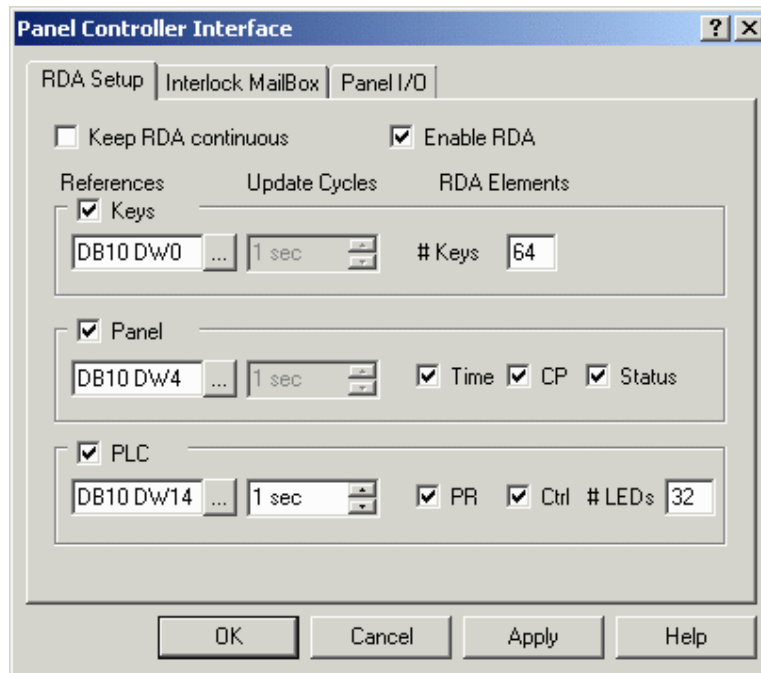

The RDA Setup tab lets you specify the Programmable Logic Controller (PLC) address for the RDA (Reserved Data Areas).

The RDA can be left as a continuous block of memory, in which case the PLC address for the start of the RDA can be specified. Alternatively, the elements of the RDA can be placed in different memory locations. In this case, the PLC starting address for each of the different elements can be specified. It also lets you enable or disable the individual elements of the RDA.

A more detailed description of the RDA is available.

#### 4.6.116 Keep RDA Continuous

Check the Keep RDA continuous box to leave the RDA as a continuous block of memory. Specify the PLC address for the start of the RDA by indicating the Reference type and location.

Note: The Keep RDA continuous option is not supported for internal controllers. The checkbox should always be always left unchecked when an internal controller is specified.

#### 4.6.117 Enable RDA

It is not necessary to have a full working knowledge of the reserved data areas to complete a project. It is entirely possible to toggle bits in the controller, display messages and

controller data, edit read/write fields, etc. without having any areas of the RDA enabled. For this reason, the RDA is disabled by default. This also helps to optimize communication between the panel and the controller. There are, however, several functions that are only available through the RDA.

Note: If you are having trouble establishing initial communication with your panel, disabling the RDA is recommended. Make sure the check box entitled Enable RDA is not checked. If it is, uncheck it and re-download your project.

#### **4.6.118 RDA References**

#### **4.6.119 RDA References**

Each UniOP panel may use up to three small reserved areas of controller memory to establish an interface with the controller. These three reference areas are: Keys, Panel, and PLC. You can select the starting address of each of these areas.

Each of the three reference areas lists References, Update Cycles, and RDA Elements. Clicking on the "..." button under References brings up the Data Field Properties dialog box where reference information can be specified. The cycle time may be set as necessary under Update Cycles. The various RDA Elements that pertain to the Keys, Panel, and PLC reference areas are discussed under those headings.

#### **4.6.120 Keys**

This reserved area is formatted to contain flags for each key on the panel and extended keyboard, up to a maximum of 64. (The maximum number must be a multiple of 16, as in essence the maximum number of keys tells the UniOP panel how many words of the Keyboard Update Area in the RDA are to be used.)

These flags are set HIGH when a key is pressed and set LOW when released. Each key status flag occupies one bit in the controller memory. These bits can be used by the controller to detect when a particular key has been pressed and then in turn perform a specific operation.

Note: Use the Keyboard Macro Editor to program keys.

#### **4.6.121 Panel**

##### **Panel**

This reserved area is formatted to contain time and date information from the panel's real time clock, a current page register, and a two-byte panel status word.

##### **Time**

The real time clock contains the time and date information. Depending upon the type of controller that is being used, this information will be stored in either binary or BCD. A listing of various PLC's and how the RTC (Real Time Clock) is stored can be found in the back of the Installation & Operation Guide that came with the panel.

**Current Page (CP) Register**

The panel writes the number of the currently displayed page into the Current Page (CP) register whenever the panel is in Page Mode or Data Entry Mode. In all other modes, a zero is written into this register, indicating that page data is not currently being displayed.

Note: Page numbers are stored in either binary or BCD format, depending on the controller being used.

**Panel Status Word**

The panel sets and resets bits S0-S8 and S13-S15 in the Panel Status Word to indicate its current status. Your application logic can monitor these bits to determine how and when it should interact with the panel. A brief description of each status bit is provided.

**4.6.122 PLC****PLC**

The PLC (programmable logic controller) update area allows the controller to access and control certain aspects of the panel.

All front panel LED's can be controlled from this area to provide feedback to the operator. The controller may also request a specific page to be displayed by writing the appropriate value into the Page Request register. The controller control word allows the controller to request the printing of a page, disable data entry, select an alarm mode, or enable the mailbox function.

All panels include a standard set of dedicated indicators that allow the user to monitor the status of the panel. Along with these dedicated indicators, certain models include a subset of user defined LED's that can be monitored and controlled by application logic. The control of these LED's is carried out through the Controller Update Area. Each of the registers found there can be copied to bit address contacts so that the status bits can be referenced as control relays.

**Page Request Register**

The page to be displayed can be selected either by the operator from the front panel keypad or by the controller itself. The controller selects the page to be displayed by writing the corresponding page number into the PR register in the Controller Update Area. When the panel detects a page request from the controller, it checks the front panel keyboard and the Expanded Keyboard (if present). If no key has been pressed for the last three seconds, the page selected by the controller is displayed.

Note: Once the panel has changed to the corresponding page, you need to write a 0 back into the PR register in order to return control back to the keys on the panel. If this is not done, you will be "stuck" on that page.

Note: While a controller page request is active (PR not 0), the operator will not be able to change pages using the arrow keys.

Note: Page numbers are stored in either binary or BCD format, depending on the controller being used.

**LED Control Bits**

Bits L1 through L32 control the LED indicators that can be found on various panel models. The mappings of these bits are provided.

Note: The LED's can be controlled via the Keyboard Macro Editor.

## 4.6.123 Interlock Mailbox

## 4.6.124 Interlock Mailbox

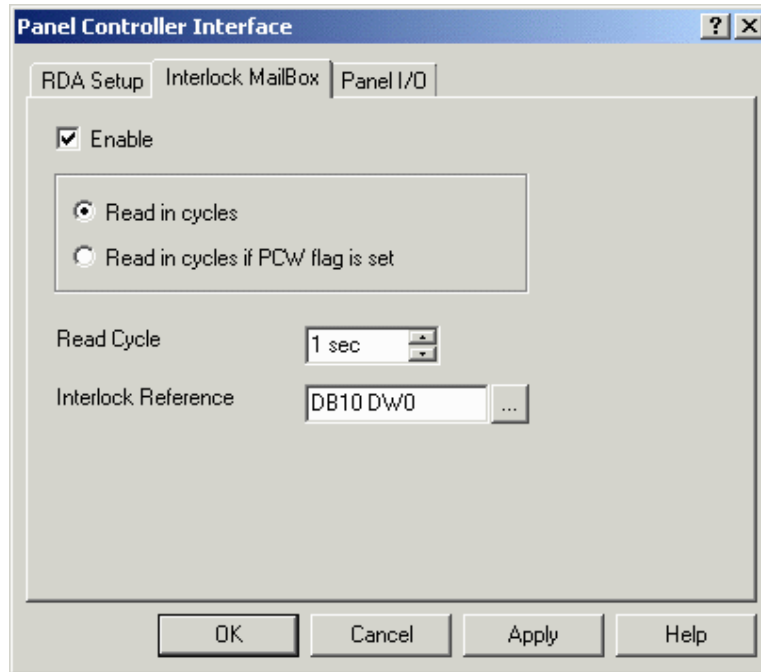

The Interlock Mailbox tab lets you enable the Interlock Mailbox, determine the read modes and the read cycle, and specify the controller address for the Interlock Mailbox.

The UniOP Interlock Mailbox is designed to allow the operator interface panel to interact with the controller's ladder logic program. The Interlock Mailbox is simply a group of registers in the controller memory (from a minimum of 2 registers to a maximum of 20).

The Mailbox can be placed anywhere in the controller memory at an address you select. When the mailbox is enabled, the operator panel cyclically reads the contents of the mailbox from the controller. The controller can command the UniOP panel to perform certain tasks by placing data in the memory area used by the mailbox. When the panel detects that the controller has written data in the mailbox, it interprets the data as a numeric code for a required command. If the panel recognizes the command, it immediately executes it. If the command requires a response from the panel, then the panel places the response back into the mailbox itself.

Further information on the Interlock Mailbox is provided.

Note: The Interlock Mailbox offers a powerful way to control the operation of recipes from the controller.

#### 4.6.125 Enable

To enable the Interlock Mailbox, select the Interlock Mailbox tab from the Panel Controller Interface dialog box under the Project menu. The Mailbox is disabled by default. To enable it, simply mark the checkbox entitled Enable.

#### 4.6.126 Read Modes

The Mailbox can be enabled in one of two ways.

Read in cycles

Read in cycles if PCW (PLC Control Word) flag is set

If the Mailbox is read in cycles, you may specify a read cycle time. The faster the read cycle time, the more often the Mailbox gets checked; however, the slower the rest of the system will become.

Or, you may set the Mailbox up such that it is only read when bit C15 in the PLC (programmable logic controller) Control Word is set.

The purpose of this mode is to reduce the overhead of the communication time when there is no need for the controller to send commands to the panel.

#### 4.6.127 Read Cycle

The Read Cycle time under Project - Panel Controller Interface - Interlock Mailbox specifies how frequently the operator panel will read the data in the mailbox to check to see if it contains a new command.

The faster the mailbox Read Cycle, the faster the panel will respond to commands from the controller.

However, the update of the variables shown on the display will be slower.

#### 4.6.128 Interlock Reference

The Interlock Reference is the address of the first Mailbox register in the controller memory. The address can be entered directly as a string or via the Data Field Properties dialog box displayed by clicking on the "... " button.

A memory map of the Mailbox in the controller memory is shown below. The Status Word and the Command/Response Word are always required for the Mailbox. Parameter 0 - Parameter 17 Words are only used if required by the particular mailbox command.

Offset	Item
0	Status Word
1	Command/Response Word

2	Parameter 0
3	Parameter 1
...	...
19	Parameter 17

Note: When entering the starting address, care must be taken to ensure that the controller memory used by the Mailbox does not overlap with the memory areas reserved for other panel functions such as alarms, I/O update, keyboard update, etc.

#### 4.6.129 Panel IO

#### 4.6.130 Panel I/O

UniOP panels with hardware type -0050 are ready to house the local I/O (Input/Output) module UIM-03. It can be used in conjunction with the internal controller to be part of its I/O, it can be used as an extension of the external controller that is connected to the UniOP panel, or it can be used as a stand-alone module.

Note: The UIM05 I/O board cannot be used with Panel I/O.

To configure the Panel I/O, select Panel Controller Interface from the Project menu and click on the Panel I/O tab.

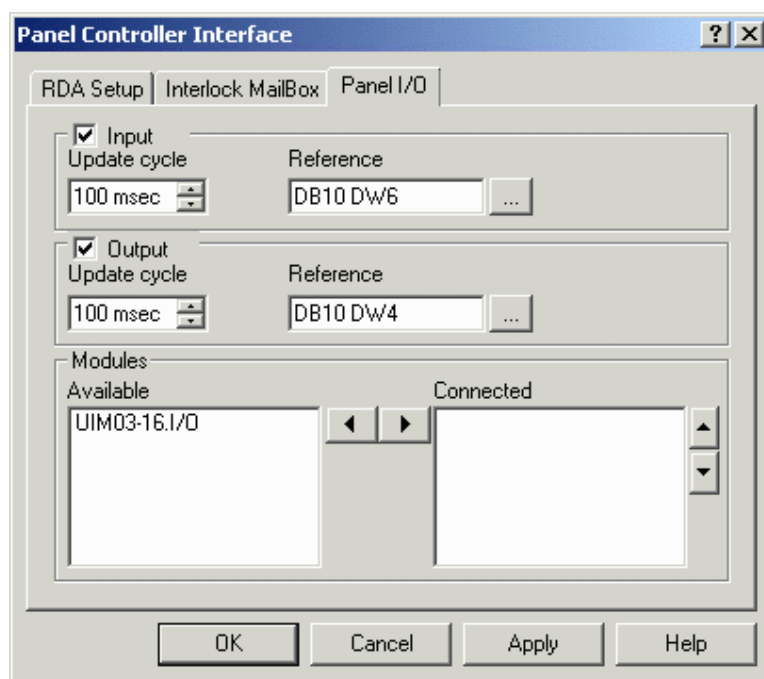

The digital I/O points of the UIM03 board can be mapped to a free memory area within the connected controller (either the internal controller or an externally connected controller). The resident PLC program will read the physical status of the UIM03 inputs from the memory area dedicated to the input points; the UIM03 outputs are controlled by the PLC user program by writing to the memory area assigned to the UIM03 output points.

You can enable and set the input and output, and specify which modules are to be connected.

#### **4.6.131      Input**

#### **4.6.132      Input**

The Input area allows you to specify the configuration parameters for the digital input points of the UIM03 board. Check to box enable panel input. The frequency of updates and the Reference location may be specified.

#### **4.6.133      Update Cycle**

Specifies the average update cycle time used by the UniOP firmware to update the external controller memory area assigned to the input points. This memory area can be specified in the Reference address.

Note: The Update cycle time needs to be selected with care, as the UniOP panel uses the same communication channel to update the local I/O as it does for communication with the external controller. If the Update cycle time is set to a value that is too small, communication performance between the UniOP panel and the external controller could be sacrificed.

#### **4.6.134      Reference**

Specifies the starting address for copying the image of the input data. Clicking on the "..." button brings up the Data Field Properties dialog box, where more detailed PLC (programmable logic controller) information may be entered.

Note: The panel I/O feature requires a minimum offset between the starting addresses of the input and output area. The difference between the starting addresses must be at least of 16 bytes. The data format used to specify the initial address can be byte, word or double word depending on the protocol.

#### **4.6.135      Output**

#### **4.6.136      Output**

The Output area allows you to specify the configuration parameters for the digital output points of the UIM03 board. Check the box to enable panel output. The frequency of updates and the Reference location may be specified.

**4.6.137 Update Cycle**

Specifies the average update cycle time used by the UniOP firmware to update the status of the physical output points. The output points are updated by reading them from the external controller memory area assigned to the output points as specified in the Reference address.

**4.6.138 Output Reference**

Specifies the starting address for copying the image of the output data. Clicking on the "..." button brings up the Data Field Properties dialog box, where more detailed PLC (programmable logic controller) information may be entered.

Note: The panel I/O feature requires a minimum offset between the starting addresses of the input and output area. The difference between the starting addresses must be at least of 16 bytes. The data format used to specify the initial address can be byte, word or double word depending on the protocol.

**4.6.139 Modules**

A list of all the local I/O boards available for use with the Panel I/O feature is provided. Use the arrow buttons to move modules from the Available list to the Connected list, and vice versa, and to specify the order of modules in the Connected list.

Note: Current UniOP hardware supports only one local I/O module.

**4.6.140 Report on Panel Printer****4.6.141 Report on Panel Printer**

It is possible to define the printer device driver and the communication parameters, the report format and the timetable on which a report is printed, to configure a key or touch cell to print a report, or to request a printout by using the Interlock MailBox.

Note: In order to use these features, the panel must contain firmware version 4.10 or higher.

**4.6.142 Printer Setup****4.6.143 Printer Setup**

To log alarms and messages, a serial printer may be connected to the panel.

Note: The same port is used for both programming the panel while in Configuration Mode and for logging information to a printer during Operation Mode.

To configure a serial printer, select Project - Report on Panel Printer - Printer Setup.



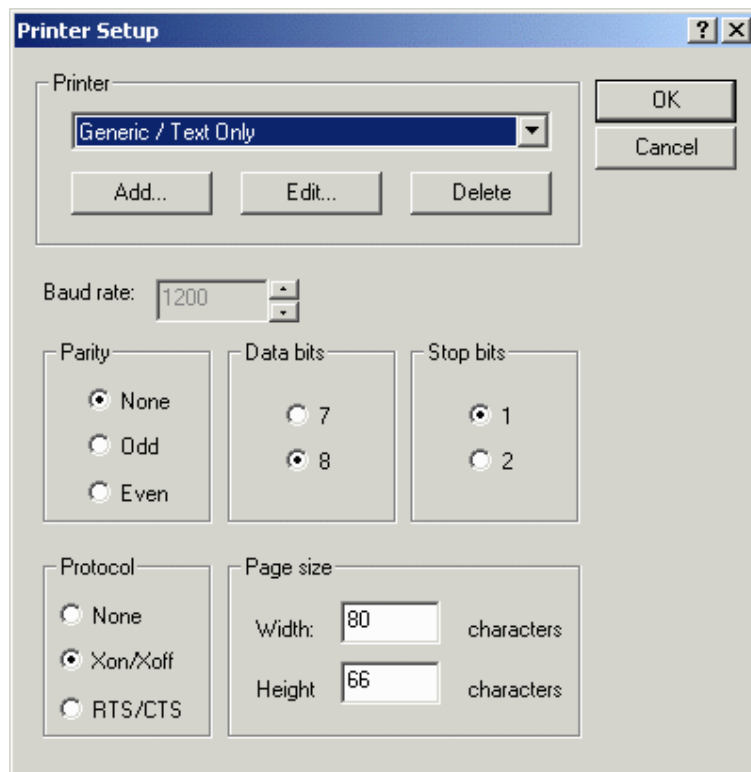

From the Printer Setup dialog box choose a printer and set the communication parameters such as baud rate, parity, stop bits, data bits, and protocol. It is also possible to define the page size.

See the Printing section for additional information on printing.

#### 4.6.144 Printer

#### 4.6.145 Printer

Select a printer type from the pull-down list. If the printer to be used is not listed, use the Add button to add a new printer to the list of available printers. Doing so will bring up the Printer Properties dialog box in which the parameters for the newly added printer can be defined. Similarly, the Edit button can be used to redefine the parameters for an existing printer. The Delete button removes the currently selected printer from the list of available printers.

Note: Any new printer must also be supported by the panel firmware. Simply defining a new printer in the Designer software may not be enough to get the new printer running.

#### 4.6.146 Printer Properties

The Printer Properties dialog box, invoked by clicking on the Add or Edit buttons from the Printer Setup dialog box, lets you configure a printer. You can enter the printer name, escape sequences, enable reversing font bitmap after rotation, make automatic linefeed selections, specify eject parameters, and make selections for graphical printouts.

**4.6.147 Printer Name**

Enter a name for this printer.

**4.6.148 Escape Sequences**

The list of escape sequences for text and graphic control. The escape sequences can be freely assigned.

**4.6.149 Reversing Font Bitmap After Rotation**

This property allows to specify if the Font Bitmap requires to be reverted after rotation.

**4.6.150 Auto Linefeed**

Radio buttons allow for a simple carriage return (CR), or a line feed (LF) after carriage return (CR/LF).

**4.6.151 Eject**

Checking the Form feed box instructs the printer to eject a blank sheet of paper following every report printed. The delay after form feed is indicated in seconds.

**4.6.152 Graphics**

Checking the Enable box indicates that the current page must be printed in graphic mode. The printer control code comes from the printer documentation. The ratio of the character width in text and graphic mode depends on the resolution of the graphical printout.

**4.6.153 Baud Rate**

This option specifies the baud rate to be used in communication between the panel and the printer.

**4.6.154 Parity**

Specifies the parity to be used in communication between the panel and the printer.

**4.6.155 Data Bits**

Specifies the number of data bits to be used in communication between the panel and the printer.

**4.6.156 Stop Bits**

Specifies the number of stop bits to be used in communication between the target panel and the controller.

**4.6.157 Protocol**

The protocol used for the panel and printer to communicate. Xon/Xoff is also known as software flow control. RTS/CTS is also known as hardware flow control.

**4.6.158 Page Size**

Specifies the width and height of the print area, in characters.

Note: If reports are to be printed, the paper height must be defined here before the report is defined. If the paper height is changed after some reports have already been defined, the previously defined report layouts will not automatically be rearranged.

**4.6.159 Reports****4.6.160 Reports**

A report is a collection of project file pages (or parts of project file pages).

The Reports dialog box under Report on Panel Printer on the Project menu lets you define the parameters of each specific report.

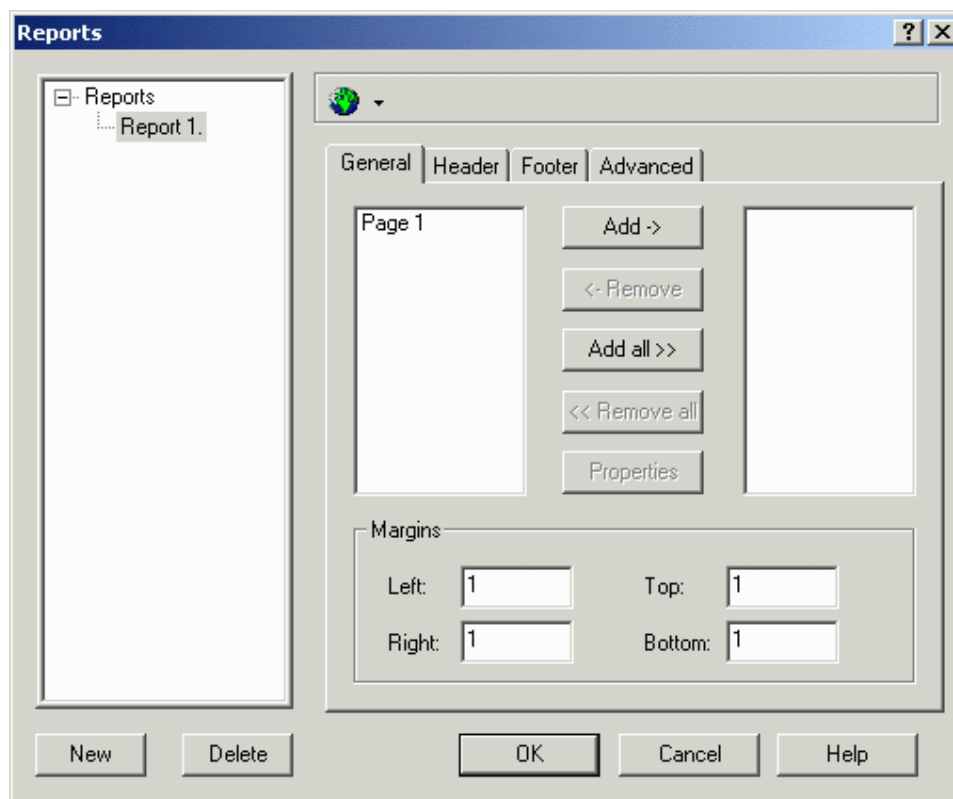

There are four tabs in the Reports dialog box: General, Header, Footer, and Advanced. Each deals with a different section of the report. A list of reports is shown on the left side of the dialog box. In addition, there are buttons to add a new report, delete an existing report, and change languages.

Note: More than one report can be created for each project file.

Note: If reports are to be printed, the paper height must be defined in Printer Setup before the report is defined.

#### **4.6.161 Report List**

A list of existing reports, if any, is shown and is available for selection.

#### **4.6.162 New**

A report may be added by clicking the New button and giving the report a name.

#### **4.6.163 Delete**

Clicking on the Delete button removes the currently selected report from the list.

## 4.6.164 Languages

Click on the Languages icon to select a language.

## 4.6.165 General

### 4.6.166 General tab

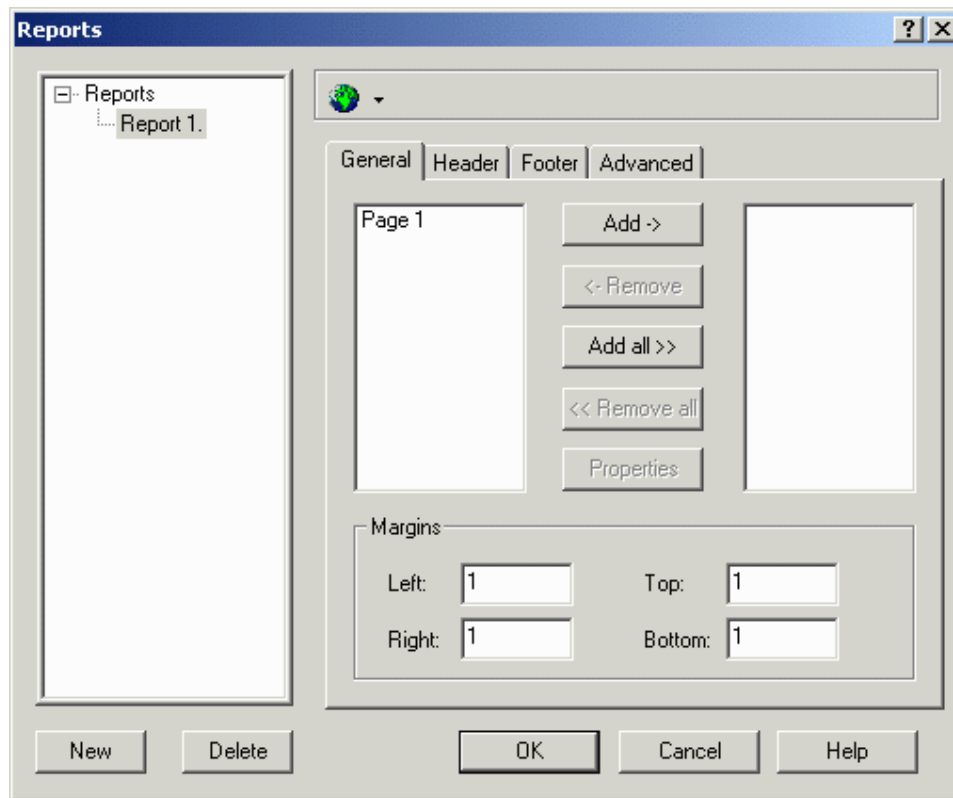

All of the pages of a project file are shown within the left-hand box. Pages in the current report are shown in the right-hand box. Use the buttons between the boxes (Add, Remove, Add all, Remove all, and Properties) to set up the reports. You can also specify margin measurements.

### 4.6.167 Add

To add a page to the current report, select a page from within the left-hand box and click on the Add-> button. Doing so will place the page name into the right-hand box.

### 4.6.168 Remove

To remove a page from the current report, select the page name from within the right-hand box and click on the <-Remove button.

**4.6.169 Add All**

To add all of the pages of your project file to a report, select the Add All>> button.

**4.6.170 Remove All**

To remove all of the pages from the report, click on the <<Remove All button.

**4.6.171 Properties**

By selecting a page of interest and pressing the Properties button, you can specify what part of the project file page to print and the font for printing in the UniOP page Property dialog box.

**4.6.172 Panel Page Property**

The Panel Page Property dialog box is accessed by clicking on the Properties button under the General tab from Project - Report on Panel Printer - Reports.

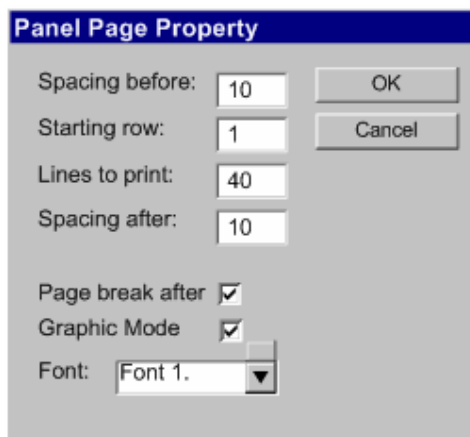

This dialog box lets you set the number of line spaces before and after the report, the starting row, the total number of lines to print, whether to put a page break after printing the report, whether to enable graphics printing, and which font to use for printing.

**4.6.173 Margins**

Set the amount of space, in characters, to be allotted as left, right, top and bottom margins on the printed reports.

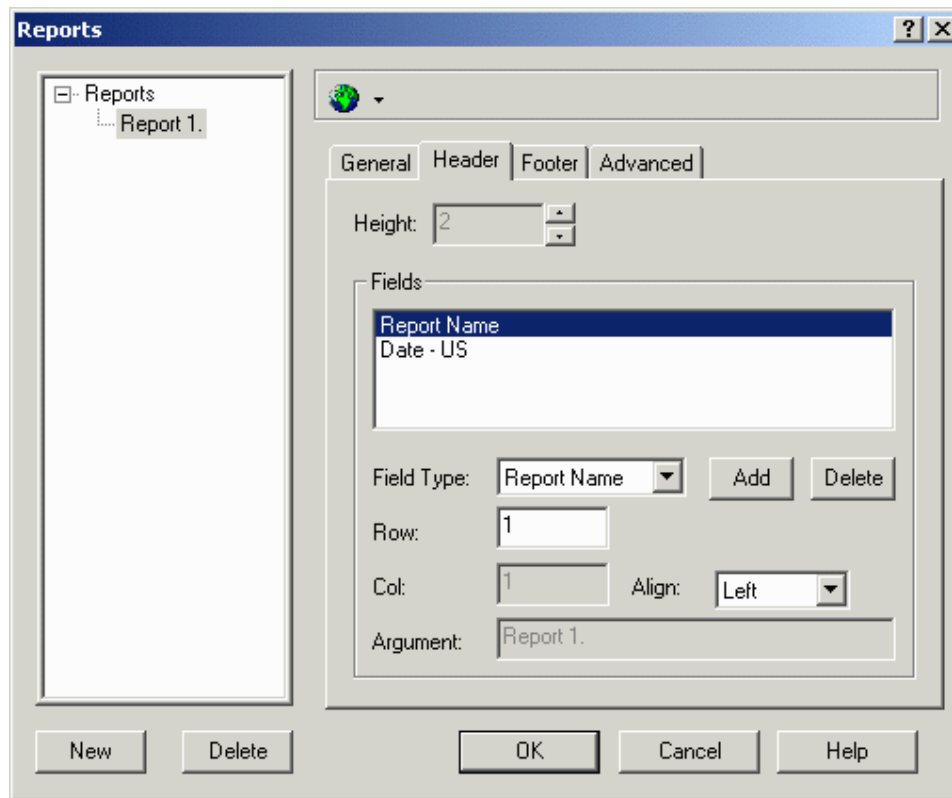
**4.6.174 Header****4.6.175 Header**

The structure of the header and the footer are the same. The header and footer both remain consistent throughout the report (i.e., the header on page 1 of a report will be the same header that appears on page 9 of a report).

You can define the height of the header. A number of predefined fields can be inserted into a header, such as the time and date, the page number, the report name and a label (which allows the user to enter static text). It is also possible to specify where the fields are inserted and how they are positioned.

**4.6.176 Height**

The height, in inches, of the header or footer.

**4.6.177 Fields****Fields**

The list of fields to be included in the header or footer, such as the time and date, the page number, the report name or a label (which lets you enter static text). To add a field to the list,

select an entry from the Field Type list. Add and Delete buttons are available. You can also specify row, column, alignment, and argument parameters for headers and/or footers.

**Field Type**

A list of predefined fields available for insertion into a header or footer. Selecting the field type Label activates the Argument entry box where the label text may be inserted.

**Add**

Clicking on the Add button inserts the item currently displayed in the Field Type list into the list of Fields to be included in a header or footer.

**Delete**

Clicking on the Delete button removes the currently selected item from the list of Fields to be included in a header or footer.

**Row**

The number of the row where the currently selected items in the Fields list will be inserted into the header or footer.

**Column**

The number of the column where the currently selected items in the Fields list will be inserted into the header or footer. This option is only available when the alignment is set as Custom.

**Align**

The alignment for the header or footer. Choices include Left, Center, Right, and Custom. If Custom is selected then a Column value may be entered.

**Argument**

Selecting the field type Label activates the Argument entry box where the label text may be inserted.

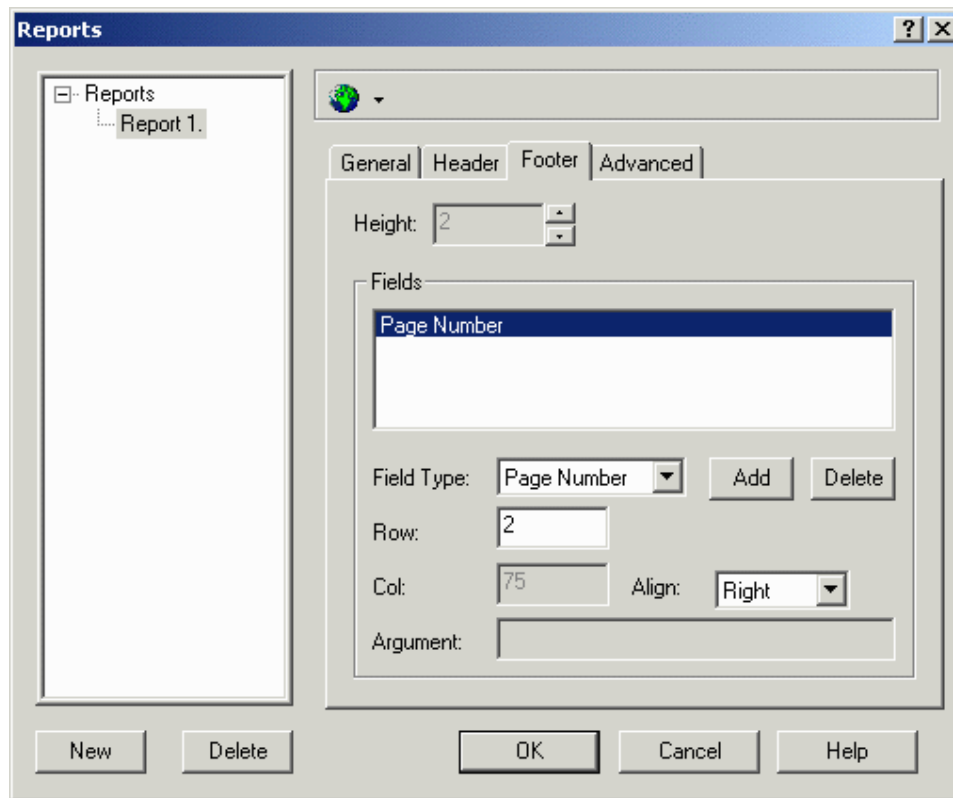

**4.6.178 Footer****4.6.179 Footer**

The structure of the header and the footer are the same.

The header and footer both remain consistent throughout the report (i.e., the header on page 1 of a report will be the same header that appears on page 9 of a report).

It is possible to define the height of the header and the footer. Several predefined fields can be inserted into a header or footer, such as the time and date, the page number, the report name and a label (which allows the user to enter static text). It is also possible to specify where the fields are inserted and how they are positioned.

**4.6.180 Height**

The height, in inches, of the header or footer.

**4.6.181 Fields****Fields**

The list of fields to be included in the header or footer, such as the time and date, the page number, the report name or a label (which lets you enter static text). To add a field to the list,

select an entry from the Field Type list. Add and Delete buttons are available. You can also specify row, column, alignment, and argument parameters for headers and/or footers.

**Field Type**

A list of predefined fields available for insertion into a header or footer. Selecting the field type Label activates the Argument entry box where the label text may be inserted.

**Add**

Clicking on the Add button inserts the item currently displayed in the Field Type list into the list of Fields to be included in a header or footer.

**Delete**

Clicking on the Delete button removes the currently selected item from the list of Fields to be included in a header or footer.

**Row**

The number of the row where the currently selected items in the Fields list will be inserted into the header or footer.

**Column**

The number of the column where the currently selected items in the Fields list will be inserted into the header or footer. This option is only available when the alignment is set as Custom.

**Align**

The alignment for the header or footer. Choices include Left, Center, Right, and Custom. If Custom is selected then a Column value may be entered.

**Argument**

Selecting the field type Label activates the Argument entry box where the label text may be inserted.

**4.6.182      Advanced**

**4.6.183      Advanced tab**

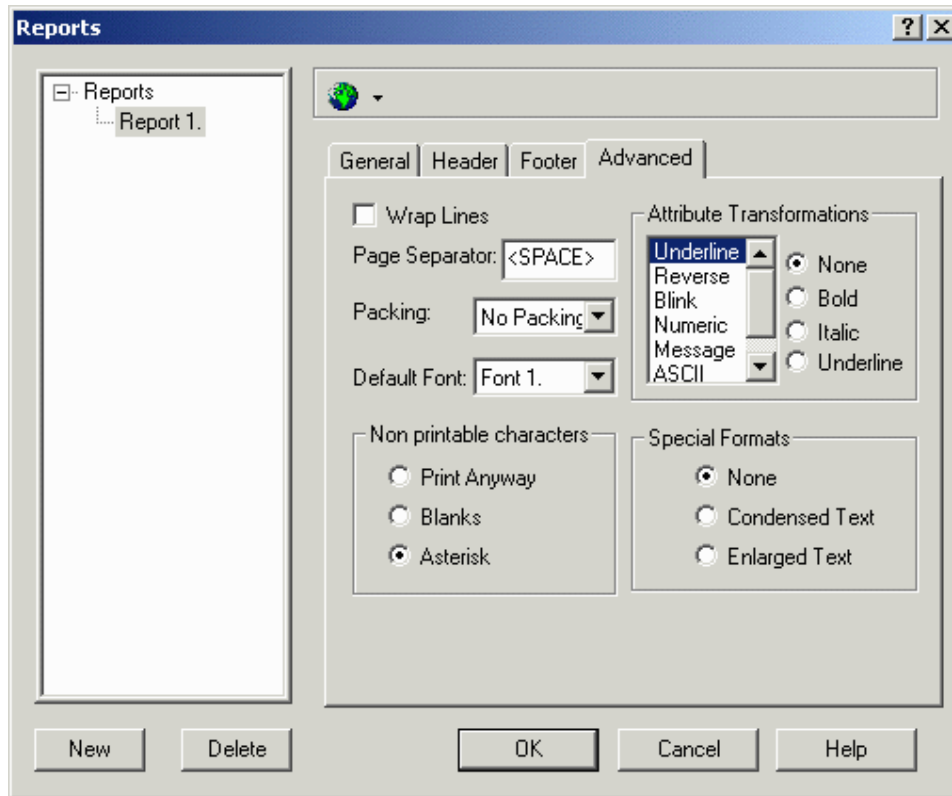

The Advanced tab allows you to select the following parameters, which are common for every page in the report.

Wrap Lines

Page Separator

Packing

Default Font

Attribute Transformations

Non-printable characters

Special Formats

**4.6.184      Wrap Lines**

If wrapping is selected, lines longer than the width of the page will be printed on the next line. If wrapping is not selected, lines longer than the width of the page will be truncated.

**4.6.185 Page Separator**

The page separator is a character that can be optionally defined as a placeholder for empty lines in the printed page.

**4.6.186 Packing**

If the page width is longer than the display width, it is possible to print two or more rows on a single line.

**4.6.187 Default Font**

Specifies the default font to use when a particular font has not been selected in the page definition dialog box. The list of available fonts depends on the printer driver.

**4.6.188 Attribute Transformations**

Display attributes such as reverse, underline, or blink, or can be transformed into another printer attribute, such as normal, underlined, bold or italicized.

**4.6.189 Non-printable Characters**

Non-printable characters can be printed as blanks or asterisks. If Print Anyway is checked, corresponding codes are sent to the printer even if the printer cannot correctly interpret them.

**4.6.190 Special Formats**

The options of printing in condensed or enlarged text are available.

#### 4.6.191 Triggers

#### 4.6.192 Triggers

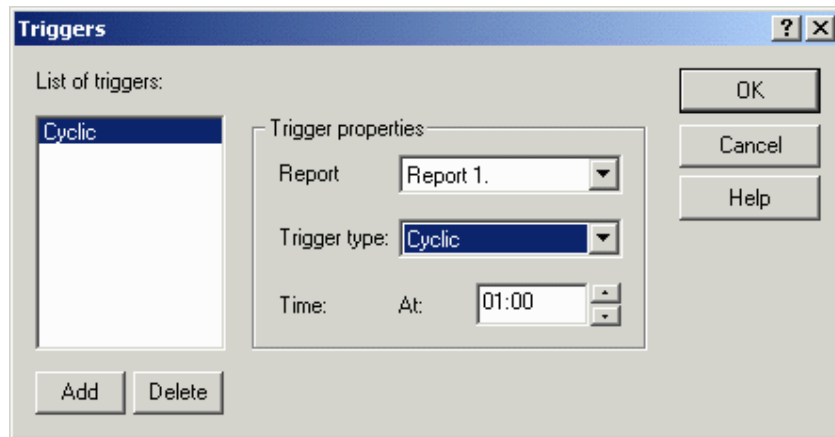

Triggers let you specify when a report is to be printed. A list of triggers is shown at the left of the box, with buttons to add and delete triggers. Trigger properties may be set on the right side of the box.

Note: It is also possible to print a report by using a function key or touch cell programmed via the Keyboard Macro Editor, or by having the PLC issue a print request by using the Interlock Mailbox command Start Report Printout.

Note: It is possible to start printing more than one report. Up to ten (10) printer requests can be stored in a FIFO (first in first out) buffer.

#### 4.6.193 List of Triggers

The report to be printed can be selected from the list of available reports as defined under Project - Report on Panel Printer - Reports.

#### 4.6.194 Add

Click on the Add button to add a new trigger.

#### 4.6.195 Delete

Click on the Delete button to the selected trigger from the list.

**4.6.196 Trigger Properties**

**4.6.197 Trigger Properties**

The trigger Type can be set as cyclic, which will print the Report at certain specified intervals (up to 99 hours apart), or every day at a specified time. The specified interval or specified time is set under Time.

**4.6.198 Report**

The name of the report to which the trigger will apply.

**4.6.199 Trigger Time**

Any report can be printed cyclically in two different modes:

cyclically after an interval of time

every day at a specific time

**4.6.200 Time**

For cyclic triggers, this is the number of hours (up to 99) between triggers. For daily triggers, this is the time of day when the report will be triggered.

**4.6.201 Passwords**

**4.6.202 Passwords**

Password	CONF TIME	ACK	PRINT PAGE	ALOGI ALOGO	From page	To page
1234	<input checked="" type="checkbox"/>	<input checked="" type="checkbox"/>	<input checked="" type="checkbox"/>	<input checked="" type="checkbox"/>	1	1
4321	<input type="checkbox"/>	<input type="checkbox"/>	<input type="checkbox"/>	<input type="checkbox"/>	1	1
	<input type="checkbox"/>	<input type="checkbox"/>	<input type="checkbox"/>	<input type="checkbox"/>	1	1
	<input type="checkbox"/>	<input type="checkbox"/>	<input type="checkbox"/>	<input type="checkbox"/>	1	1
	<input type="checkbox"/>	<input type="checkbox"/>	<input type="checkbox"/>	<input type="checkbox"/>	1	1
	<input type="checkbox"/>	<input type="checkbox"/>	<input type="checkbox"/>	<input type="checkbox"/>	1	1
	<input type="checkbox"/>	<input type="checkbox"/>	<input type="checkbox"/>	<input type="checkbox"/>	1	1
	<input type="checkbox"/>	<input type="checkbox"/>	<input type="checkbox"/>	<input type="checkbox"/>	1	1

Logout timeout:

This feature lets you password protect the project file so that unauthorized uploads cannot occur. Four-digit passwords are used.

Once a password is specified, every time a user attempts to upload the project from the panel onto a computer, the password is requested. If the password entered matches the one that was defined in the project file, the upload operation will be performed properly.

However, if a password is entered that doesn't match the one that was specified in the project file, the panel will not start the upload process.

Note: Panels must contain firmware version 4.10 or later to use this feature.

UniOP panels have eight different levels of passwords, enabling supervisors to restrict the amount of control an operator has over the functionality of the panel.

The person having the highest level password has access to all of the panel functions. This is done by default so as to allow at least one person the ability to change the project file contained within the panel.

If a checkbox is selected, the panel user will have access to the respective area providing the correct password is entered. If an incorrect password is entered, asterisks will be displayed on the panel and the previous valid password is lost.

An example is provided.

Available password options include:

CONF,

TIME,

ACK,

PRINT,

PAGE,

ALOGI,

ALOGO, and

Data entry enable.

#### **4.6.203      CONF**

Access to Configuration Mode. In this mode, you may choose to alter the project file and re-download it from the PC.

#### **4.6.204      TIME**

Access to the Time & Date Mode. In this mode, you may change the time and date information that is stored within the panel.

**4.6.205 ACK**

The ability to acknowledge alarms.

**4.6.206 PRINT**

The ability to request printouts.

**4.6.207 PAGE**

Access to Direct Page Selection Mode. In this mode, you can access specific pages of the project.

**4.6.208 ALOGO**

Automatic logoff. This is used to automatically disable a specified password in the following cases:

inserting another valid password,

inserting a wrong password

using the macro command Password logout

after a specified period of time with no panel activity

It is possible to specify a custom timeout for passwords configured with automatic logout using Logout timeout.

**4.6.209 Data Entry Enable**

Access to Data Entry Mode for specific pages. In this mode, you can edit any read/write fields contained within the specified pages.

**4.6.210 ALOGI****4.6.211 ALOGI**

Automatic login. This is used to automatically load a specified password whenever there is no valid password in the system (e.g., when the panel goes from Configuration Mode to Operation Mode, or when an incorrect password is entered. This option can only be assigned to one password and will work only if there are no other valid passwords in the system.



The automatic login feature allows users to change any of the user passwords defined in the project file directly from the panel. In order to do this, there must be at least two passwords defined, with one of them setup to be automatically logged in. This means that whenever the panel goes from Configuration Mode to Operation Mode, the specified password is logged in.

Once the passwords are defined in the project file, an ASCII control variable field is needed for each password that the panel user will be able to change.

An example of the automatic login feature is provided.

Note: In order to use this feature, the panel must be equipped with firmware version 4.10 or later.

Note: Only one password per project can have the automatic login feature enabled.

#### 4.6.212 Password Automatic Login Example

To program a control variable field to perform the password automatic login function, you need to perform two basic steps: create the password file, and create control variables to manipulate the passwords. The individual steps are as follows:

Select Passwords from the Project menu.

Set up four passwords: 1234, 4321, 6574, and 9809.

Check the ALOGI box for password 6574. The Passwords dialog box will resemble that shown below. Note that there are eight possible passwords, and that ALOGI is checked for password number three in the list.

Password								Data entry enable		OK	Cancel
	CONF	TIME	ACK	PRINT	PAGE	ALOGI	ALOGO	From page	To page		
1234	<input checked="" type="checkbox"/>	<input checked="" type="checkbox"/>	<input checked="" type="checkbox"/>	<input checked="" type="checkbox"/>	<input checked="" type="checkbox"/>	<input type="checkbox"/>	<input type="checkbox"/>	1	1		
4321	<input type="checkbox"/>	<input type="checkbox"/>	<input type="checkbox"/>	<input type="checkbox"/>	<input type="checkbox"/>	<input type="checkbox"/>	<input type="checkbox"/>	1	1		
6574	<input type="checkbox"/>	<input type="checkbox"/>	<input type="checkbox"/>	<input type="checkbox"/>	<input type="checkbox"/>	<input checked="" type="checkbox"/>	<input type="checkbox"/>	1	1		
9809	<input type="checkbox"/>	<input type="checkbox"/>	<input type="checkbox"/>	<input type="checkbox"/>	<input type="checkbox"/>	<input type="checkbox"/>	<input type="checkbox"/>	1	1		
	<input type="checkbox"/>	<input type="checkbox"/>	<input type="checkbox"/>	<input type="checkbox"/>	<input type="checkbox"/>	<input type="checkbox"/>	<input type="checkbox"/>	1	1		
	<input type="checkbox"/>	<input type="checkbox"/>	<input type="checkbox"/>	<input type="checkbox"/>	<input type="checkbox"/>	<input type="checkbox"/>	<input type="checkbox"/>	1	1		
	<input type="checkbox"/>	<input type="checkbox"/>	<input type="checkbox"/>	<input type="checkbox"/>	<input type="checkbox"/>	<input type="checkbox"/>	<input type="checkbox"/>	1	1		
	<input type="checkbox"/>	<input type="checkbox"/>	<input type="checkbox"/>	<input type="checkbox"/>	<input type="checkbox"/>	<input type="checkbox"/>	<input type="checkbox"/>	1	1		

Logout timeout:

Click OK.

Create an ASCII control variable field by selecting Insert - Data Fields - Numeric/ASCII, or by clicking on the Numeric Field icon in the toolbar.

Set the Style as ASCII.

Set the Reference as Variable.

Click the "..." button under Reference.

Set the Data Type as Password. (If Password is not available as a data type, go back to step 6 and set the Style as ASCII.)

In the Password box, enter 3. The arrows can be used to scroll from 2 through 8. That is because there are eight possible passwords, as noted in step 3 above. Automatic login is only available for passwords 2 through 8. Our example has automatic login set for password 3 (9809). The Data Field Properties dialog box will resemble that shown in the figure below.

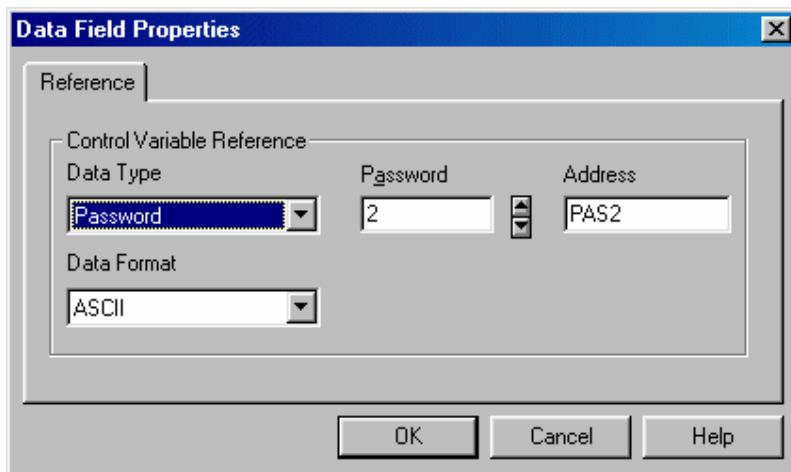

Click OK to close the Data Field Properties dialog box.

Select the Range tab in the Numeric Field Properties dialog box. Select Read/Write so that you can change the value of this field (the actual password).

Click OK to close the Numeric Field Properties dialog box.

The automatic login control variable field is indicated on the project page by "CCCC".

#### **4.6.213 Logout Timeout**

The period of inactivity that will trigger an automatic logoff. The valid range is 10-700 seconds.

#### **4.6.214 Password Example**

Assume there are three users who will have access to the operator panel. User 1 is to have access to all areas of the project (at least one user must have this type of access in every

project). User 2 is only allowed to acknowledge alarms and enter data on pages 2, 3, and 4. User 3 is capable of entering data throughout the project and is allowed into Configuration Mode. It is also desired to have User 3 automatically logged out of the system after 10 minutes.

Select Passwords from the Project menu. This will bring up a dialog box similar to the one shown in the figure below in which we will configure our passwords for the project.

Password	CONF	TIME	ACK	PRINT	PAGE	ALOGI	ALOGD	Data entry enable From page	To page
<input type="text"/>	<input checked="" type="checkbox"/>	<input checked="" type="checkbox"/>	<input checked="" type="checkbox"/>	<input checked="" type="checkbox"/>	<input checked="" type="checkbox"/>	<input type="checkbox"/>	<input type="checkbox"/>	1	1
<input type="text"/>	<input type="checkbox"/>	<input type="checkbox"/>	<input checked="" type="checkbox"/>	<input type="checkbox"/>	<input type="checkbox"/>	<input type="checkbox"/>	<input type="checkbox"/>	2	4
<input type="text"/>	<input checked="" type="checkbox"/>	<input type="checkbox"/>	<input type="checkbox"/>	<input type="checkbox"/>	<input type="checkbox"/>	<input type="checkbox"/>	<input type="checkbox"/>	1	10
<input type="text"/>	<input type="checkbox"/>	<input type="checkbox"/>	<input type="checkbox"/>	<input type="checkbox"/>	<input type="checkbox"/>	<input type="checkbox"/>	<input type="checkbox"/>	1	1
<input type="text"/>	<input type="checkbox"/>	<input type="checkbox"/>	<input type="checkbox"/>	<input type="checkbox"/>	<input type="checkbox"/>	<input type="checkbox"/>	<input type="checkbox"/>	1	1
<input type="text"/>	<input type="checkbox"/>	<input type="checkbox"/>	<input type="checkbox"/>	<input type="checkbox"/>	<input type="checkbox"/>	<input type="checkbox"/>	<input type="checkbox"/>	1	1
<input type="text"/>	<input type="checkbox"/>	<input type="checkbox"/>	<input type="checkbox"/>	<input type="checkbox"/>	<input type="checkbox"/>	<input type="checkbox"/>	<input type="checkbox"/>	1	1
<input type="text"/>	<input type="checkbox"/>	<input type="checkbox"/>	<input type="checkbox"/>	<input type="checkbox"/>	<input type="checkbox"/>	<input type="checkbox"/>	<input type="checkbox"/>	1	1

Logout timeout:

Since User 1 is to be allowed full access to all areas of the panel, we can assign the highest-level password to him. Simply click in the top password box and enter a four-digit password for User 1. By default, User 1 has access to all areas of the project.

User 2 is allowed to acknowledge alarms and enter data on pages 2, 3, and 4. Click on the second password box and enter a four-digit password for User 2. To allow access to acknowledge alarms, click on the ACK box. Doing so places a check mark in the box. To allow data entry from page 2 to page 4, enter a 2 in the Data entry enable From page box and a 4 in the Data entry enable To page box.

User 3 can enter data on all pages of the project, will be automatically logged out after ten minutes, and can access Configuration Mode. Click on the third password box and enter a four-digit password for User 3. Click in the CONF box to give User 3 access to Configuration Mode. Check the ALOGO box to enable automatic logout. The default time in the Logout timeout box at the bottom of the dialog box is 600 seconds, or ten minutes, so no changes are necessary. Because User 3 will be allowed data entry throughout the entire project, set the entries for the Data entry enable From page box and the Data entry enable To page to span all the pages in the project. For example, if the project consists of 10 pages leave the default setting of 1 in the Data entry enable From page box and set the Data entry enable To page to 10.

The passwords should now be configured correctly for this situation. The dialog box representing this situation is shown below.

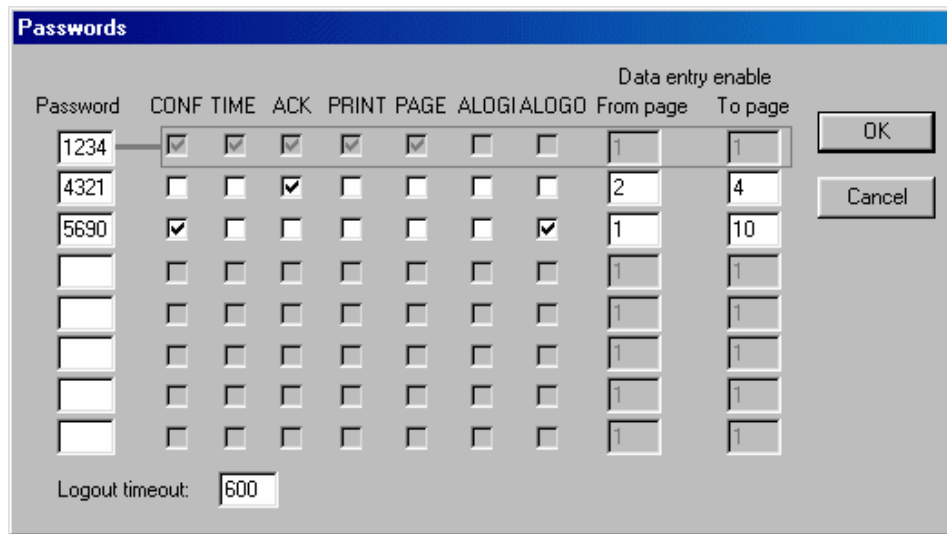

**4.6.215 Languages**

**4.6.216 Languages**



This feature lets you create a single project file that contains multiple languages. The language that the project file uses can be selected at run time.

Note: You must type in the text in each language. Designer does not have the ability to translate from one language to another. In other words, if you enter text in English and then select Spanish as the language, the text must then be entered in Spanish. By storing the appropriate text translated into various languages, you can easily change the language as needed at run time.

Note: The standard ASCII character set is used for all languages. Other symbols may be inserted using Special Characters.

To set up languages, select Languages from the Project menu. Doing so will bring up the Configure Languages dialog box where you can define the languages to be used. Insert, Delete, Move Up, Move Down, and Set As Default icons help you manage the list of languages. A counter displays the number of languages defined for the project.

A Languages icon is available on many toolbars in Designer to make it easy to switch to another language.

To change the language that a project file uses once it has been downloaded to the UniOP panel, you can create a control variable with a data type of Language.

#### **4.6.217      Insert**

Use the Insert icon to add a new language. Enter the name of the language to be added. The language is added to the list of languages, placed at the end of the list.

#### **4.6.218      Delete**

The Delete icon is used to remove a language from the list.

#### **4.6.219      Move Up**

Click the Move Up icon to move a selected language up one position in the list of languages.

#### **4.6.220      Move Down**

Click the Move Down icon to move a selected language down one position in the list of languages.

#### **4.6.221      Set As Default**

Click the Set As Default icon to set the selected language as the default language for the project. The default language is labeled as such in the list of languages.

#### **4.6.222      List of Languages**

Lists the languages that are currently available for the project.

#### 4.6.223 Number of Languages

Indicates the number of languages that have been defined for the project.

#### 4.6.224 Next Language

This option selects the next language from the list of available languages within the project file. For example, assume that there are three languages defined: Italian, English and German. If you are currently working with Italian, selecting Next Language will change the working language to English. Next Language may be selected from the Project menu or by pressing the Shift+Ctrl+L keys.

#### 4.6.225 Configure Tag Dictionaries

#### 4.6.226 Configure Tag Dictionaries

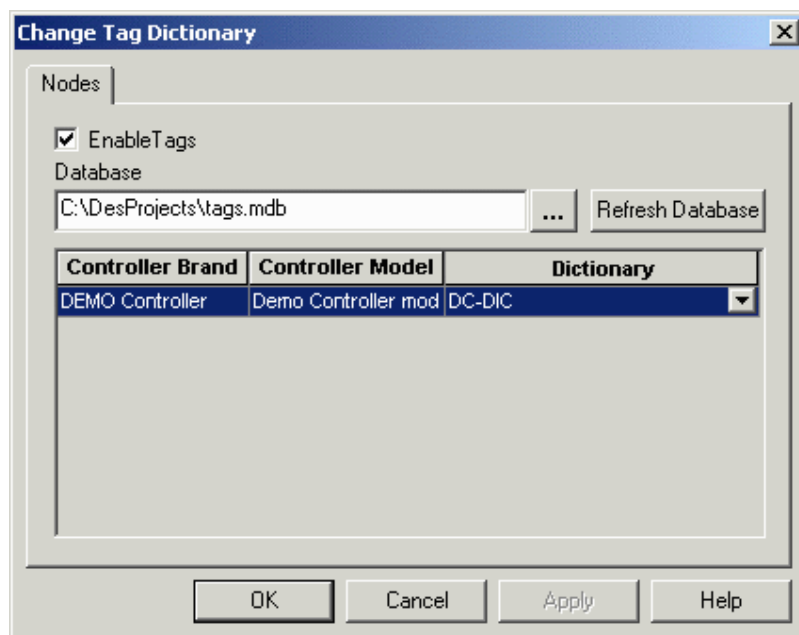

Tags allow symbolic reference to PLC variables. Tags in a project can be imported from a description file outside Designer. A discussion of the use of tags in Designer projects is provided, along with an example of using tags.

Tag dictionaries are tools integrated with Designer accessible from Project - Configure Tag Dictionaries once support for an internal controller has been enabled under Configure Controller. This lets you to switch from one tag dictionary to another tag dictionary without having to change each field in the project.

Items in the Select Tag Dictionary dialog box include the Enable Tags checkbox, the Database box, the Refresh Database button, and the Controller List.

Note: When a tag name is selected, the PLC Reference information will be filled in with the reference information from the tag and the PLC Reference dialog controls will be disabled. You will only be able to change tag information from the Tag Editor in the Tools menu.

Note: Tag definition for an External Controller is allowed only if the External PLC supports tag definitions. Please refer to EXOR Technical Documentation for further information about drivers that support tag definition.

A tag dictionary is associated with each project and defines the model and attributes of the PLC. You can select a dictionary for your project when you enable the tag feature in the project for the first time.

You can create multiple tag dictionaries inside a tag database and add tags to each dictionary. Each dictionary is configured for a specific PLC controller and model name. Each project is assigned to a dictionary.

You can create multiple dictionaries in a database in order to support a project that has a PLC Network and/or UniNET Network. To be able to use tags for a project that supports the UniNET/PLC Network, at least one dictionary must exist in the database for each of the nodes in the network.

Note: If a project supports a UniNET/PLC network, each UniNET node/ PLC Node must be tied to a tag dictionary in the database. You will be required to assign a tag dictionary for all the nodes during the configuration of UniNET/PLC network. Each node must have at least one dictionary in the database. If PLC network is enabled and you change the PLC Node, the Tag Name controls will be initialized with the tags from the dictionary tied to the current PLC Node.

#### **4.6.227 Enable Tags**

Checking this box enables the use of tags.

#### **4.6.228 Database**

The location of the tag database to be used is listed. Click on the "..." button to select the location of a tag database file (file format \*.mdb). Tag dictionaries are tied to controller brands and models.

#### **4.6.229 Refresh Database**

Click on the Refresh Database button to reset the tag database to the default settings for the specified controller.

#### **4.6.230 Controller List**

Lists the selected brand and model of controller and the matching tag dictionary.

#### **4.6.231 Tag Validation**

By using this feature you can switch from one tag dictionary, referring to one set of PLC addresses, to a different dictionary, referring to different set of PLC addresses in the same controller, and update all the fields in the project without needing to update the individual PLC addresses used in the whole project.

Also, you can switch from one tag dictionary, referring to Controller A to a different dictionary, referring to controller B and update all the fields in the project without updating the individual PLC addresses used in the whole project.

This feature can also validate the PLC addresses used in a project with respect to the PLC addresses used in the tag dictionary, and finds and lists any discrepancy items with all details such as location, etc.

This feature supports updating the tag database (with regard to PLC Address used in the project) and updating the project field (with regard to PLC Address used in the tag dictionary).

When a dictionary is changed, Designer will scan each field in the project, retrieve the tag name for the field and then check if the tag name exists in the new dictionary. If the tag name exists in the new dictionary, the PLC address for the tag will be updated in the project. If the tag name does not exist, the address information will be set to default address of the PLC. After all fields have been checked, a dialog box will be displayed listing the tag names that were not found in the new dictionary and set to default address.

The idea behind changing the tag dictionary is to let you switch tag dictionaries for similar PLCs or PLCs that use the same tag names. For example, if you have two different PLCs that use the same PLC program, you can change the tag dictionary in the project and Designer will automatically update the addresses for the tags in the project.

An example of using the tag validation feature is provided.

#### **4.6.232 Trend Buffers**

#### **4.6.233 Trend Buffers**

Trending is divided into two main parts: trend acquisition and trend viewer. The acquisition module is responsible for collecting the data into a database. This is configured using the Configure Trend Buffers dialog box, accessed by selecting Trend Buffers from the Project menu. The trend viewer is responsible for displaying the data from this database in a graphical format. This is configured using the Trend Window command from the Insert menu.



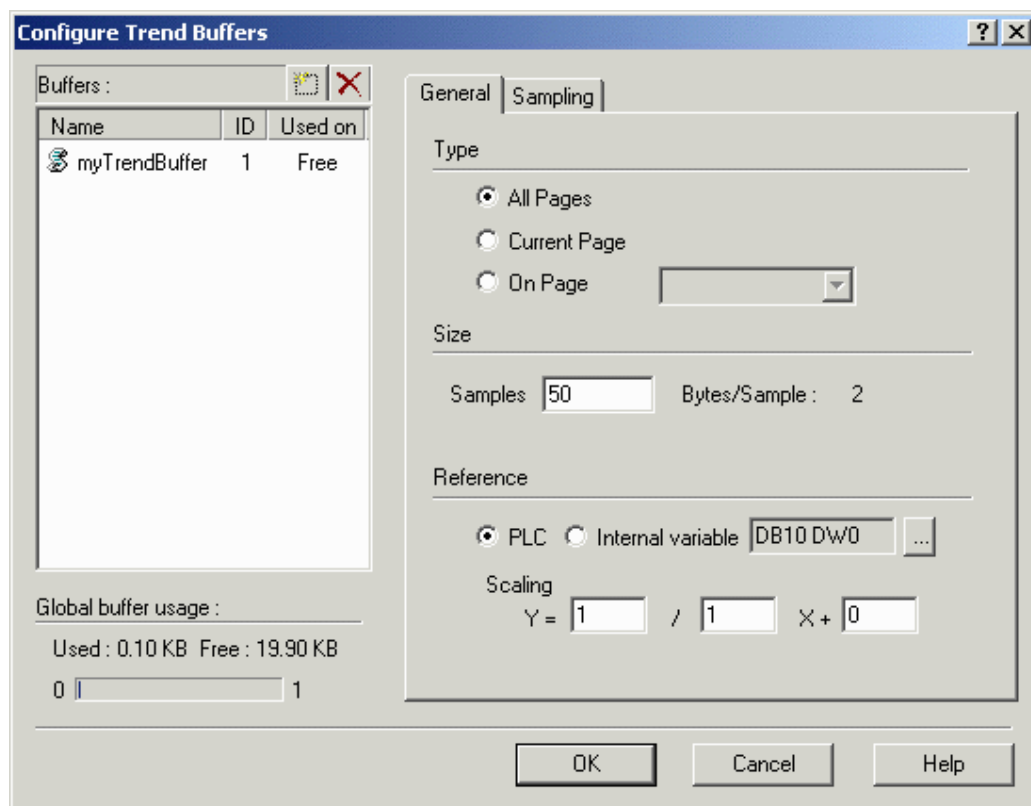

The Configure Trend Buffers dialog box is composed of a list of buffers, a General tab and a Sampling tab.

The first step in creating a trend is to create a trend buffer. You will need to define two items:

the PLC variable that is to be sampled and

the method in which the variable is to be sampled.

The variable can be sampled from the UniOP panel or the variable can be sampled directly from the PLC.

If the variable is sampled from the UniOP panel, all of the data from the trend buffer will be stored within the memory of the UniOP panel. If the variable is sampled directly from the PLC, the data from the trend buffer will be stored in the memory of the PLC. In the latter case, the only duty of the UniOP will be to graphically display the trend buffer data from the PLC.

There are two Keyboard Macro Editor commands associated with trending. These are: Trend buffer print and Trend Window.

**4.6.234 Buffers**

**4.6.235 Buffers**

Provides a list of the currently defined trend buffers and statistics on global buffer usage.

This list has two buttons. The first one is used to Insert a new buffer. The second one to Delete the currently selected one.

**4.6.236 Delete**

To remove a previously defined trend buffer, select the name of the buffer from the trend buffer list and click the Delete button.

**4.6.237 New (Insert)**

Click the New (Insert) button to add a new trend buffer name at the end of the list of trend buffers. Or, simply type the name of a new trend buffer into the box in the Buffers list.

**4.6.238 General**

**4.6.239 General tab**

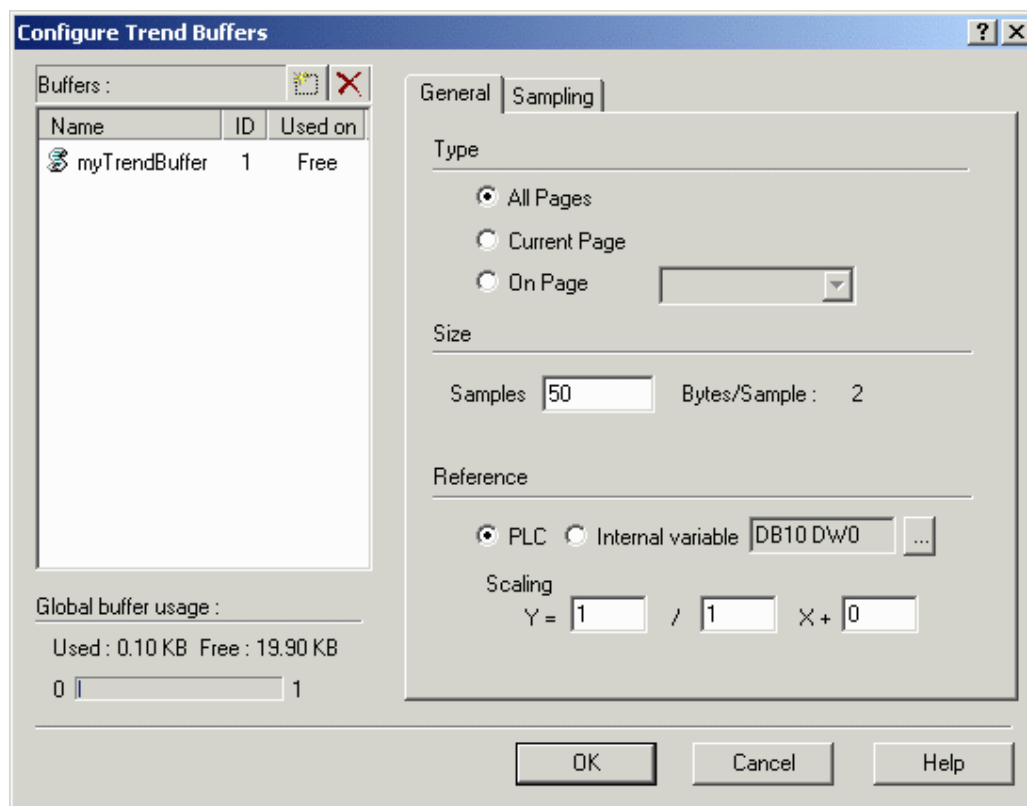

To activate the General tab, you must first select a buffer from the Buffers list. Then specify the Size and Type of buffer to be defined and the Reference Variable to be sampled.

**4.6.240 Type**

**4.6.241 Type**

Trends can be sampled in three different ways. The first option (All Pages) is to continuously sample the trend buffer, regardless of whether or not the trend associated with the trend buffer is being displayed. The second option (Current Page) is to sample the trend buffer only when the page where the trend associated with the trend buffer is being displayed. The third option (On Page) is to sample the trend buffer only when a particular page is being displayed.

Note: The number of trends that can be sampled in the background is limited.

## **4.6.242 All Pages**

The trend buffer will be sampled regardless of what page is being displayed.

## **4.6.243 Current Page**

The trend buffer will be sampled only when the page containing the trend associated with the trend buffer is displayed.

## **4.6.244 On Page**

The trend buffer will be sampled only when the identified page is displayed.

## **4.6.245 Size**

Indicate the buffer size, i.e., the number of samples that will be kept during the background sampling.

Note: When a trend is sampled in the background (All Pages), the sample size reflects the number of old samples that will be shown when the page that contains the trend associated with the trend buffer is displayed. When a trend is sampled in real time (Current Page), you will never see any old samples because sampling begins when the page that contains the trend is displayed. In this configuration the sample size is useful only when using the macros to scroll the trend along the X-axis. If these macros will not be used, you can save UniOP memory by setting the sample size to 1.

## **4.6.246 Reference**

## **4.6.247 Reference**

The variable to be sampled. This can be a PLC variable or an internal UniOP control variable. You can scale this variable, if desired.

## **4.6.248 PLC**

If the variable to be sampled is a PLC variable, click on the "..." button to define the Data Field Properties.

## **4.6.249 Internal Variable**

If the variable to be sampled is an internal variable, pick the type of variable from the list provided.

## 4.6.250 Scaling

Allows for a linear transformation of the data being sampled. This lets you scale the data before storing it inside the trend buffer.

## 4.6.251 Sampling

## 4.6.252 Sampling tab

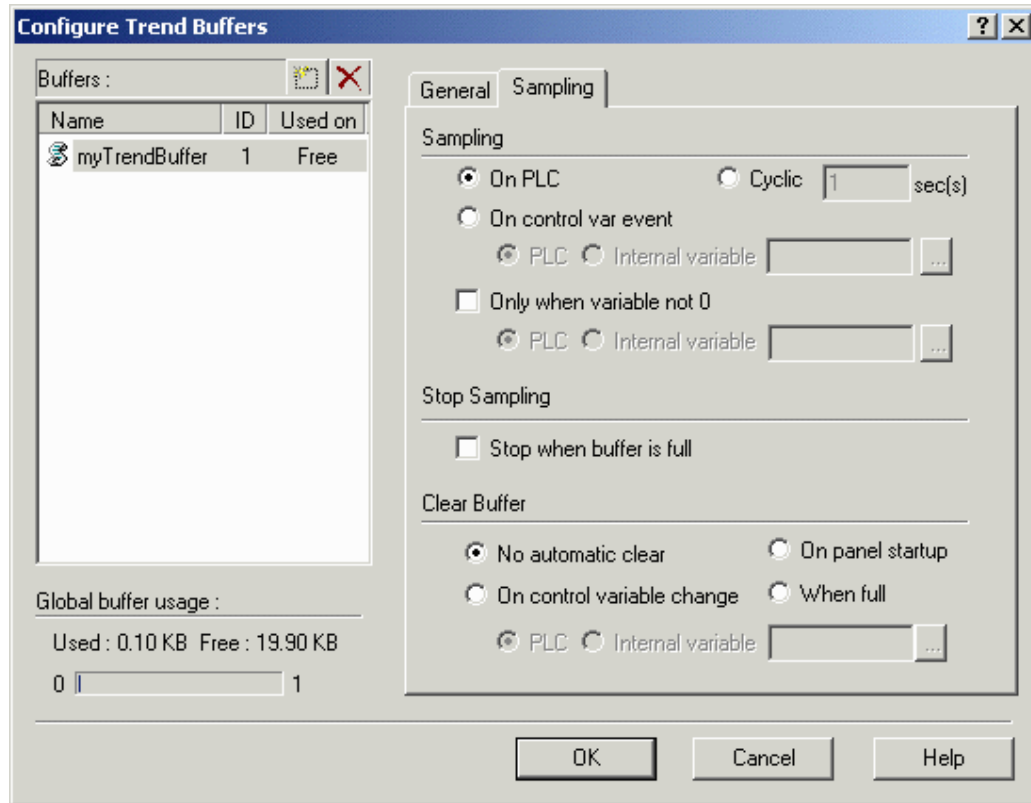

This area lets you define when and how trend samples will be taken. You can set the sampling circumstances, select to stop sampling when the buffer is full, and determine when to clear the buffer.

## 4.6.253 Sampling

## 4.6.254 Sampling

Sampling selections include sampling on PLC, cyclic sampling, sampling on a control variable event, or sampling only when the variable is not zero.

**4.6.255 On PLC**

Samples are collected from the trend buffer and stored inside the memory of the PLC.

**4.6.256 Cyclic**

Samples are taken from the memory of the UniOP on a cyclical basis. The cycle time, in seconds, must be defined.

**4.6.257 On Control Variable Event**

Samples are taken, one a time, when a variable (PLC or internal variable) changes value.  
Tip: Use a counter to trigger the sampling: 000->001->002->003....

**4.6.258 Only When Variable Not 0**

When this checkbox is set, data will be sampled only when the defined variable does not contain a value of zero. Sampling is suspended when the variable contains a value of zero. This checkbox can be set with any of the other sampling types.

**4.6.259 Stop Sampling**

Use the Stop when buffer is full checkbox to stop the sampling when the trend buffer is full. This is a first-in first-out (FIFO) buffer. Once the buffer is full, older sample values will be erased to allow the new sample values to be stored.

**4.6.260 Clear Buffer****4.6.261 Clear Buffer**

This option lets you define when to clear the trend buffer. Choices include no automatic clear, clear on panel startup, clear on control variable change, and clear when buffer is full.

**4.6.262 No Automatic Clear**

The trend buffer is never cleared. However, if the Stop when buffer is full checkbox is not selected, the oldest sample is removed and the newest sample is stored when the buffer is filled.

## 4.6.263 On Control Variable Change

The trend buffer is cleared when the selected variable changes value.

## 4.6.264 On Panel Startup

The trend buffer is cleared upon power-up of the UniOP panel.

## 4.6.265 When Full

The entire trend buffer is cleared when it becomes full.

## 4.6.266 Memory Use

You can determine how much memory is used by the current project file by selecting Memory Use from the Project menu (or by pressing the Ctrl+M keys).

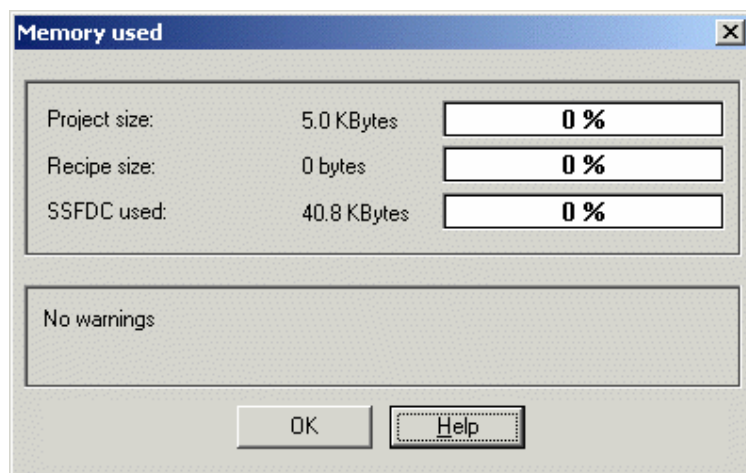

The Memory used dialog box appears containing information on the amount of memory that is used by the project file, how many bytes of recipe data are contained within the project file and the amount of memory used by an SSFDC memory card.

## 4.6.267 Time Scheduled Triggers

The Time Scheduled Triggers give you the possibility to program the Panel Operator to execute specific macro sequences cyclically or at specific time. It may be invoked by selecting Time Scheduled Triggers from the Project menu.

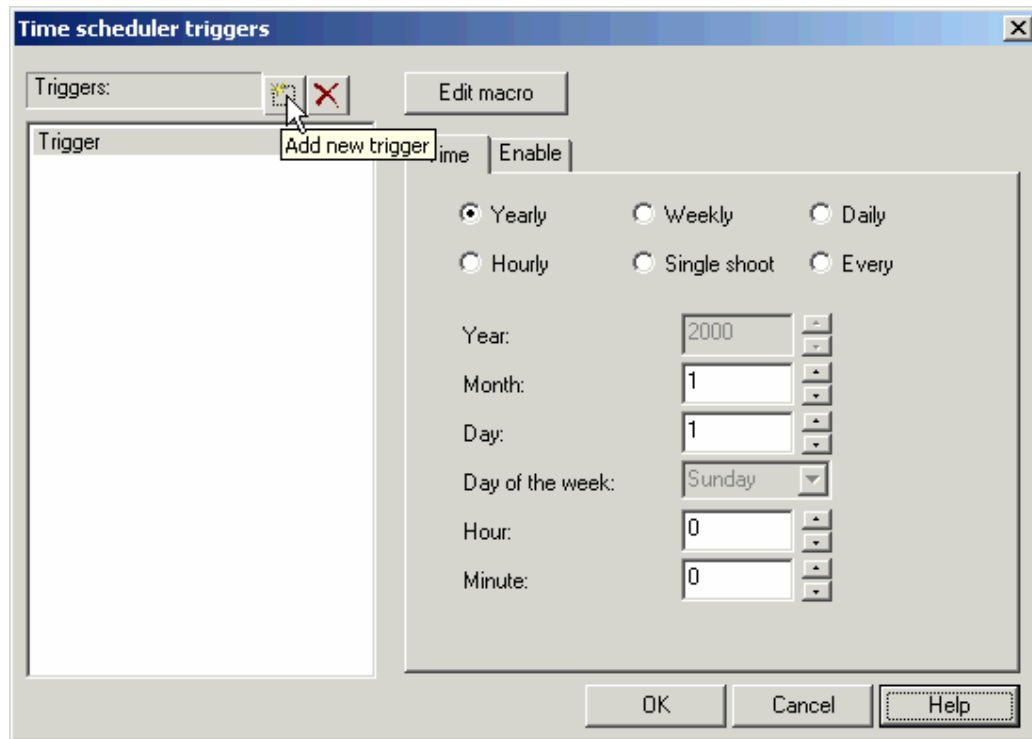

New Triggers can be added as shown in the above figure. Using the Edit Macro button, each trigger can be assigned macros from the list schedule at specific time as shown below.

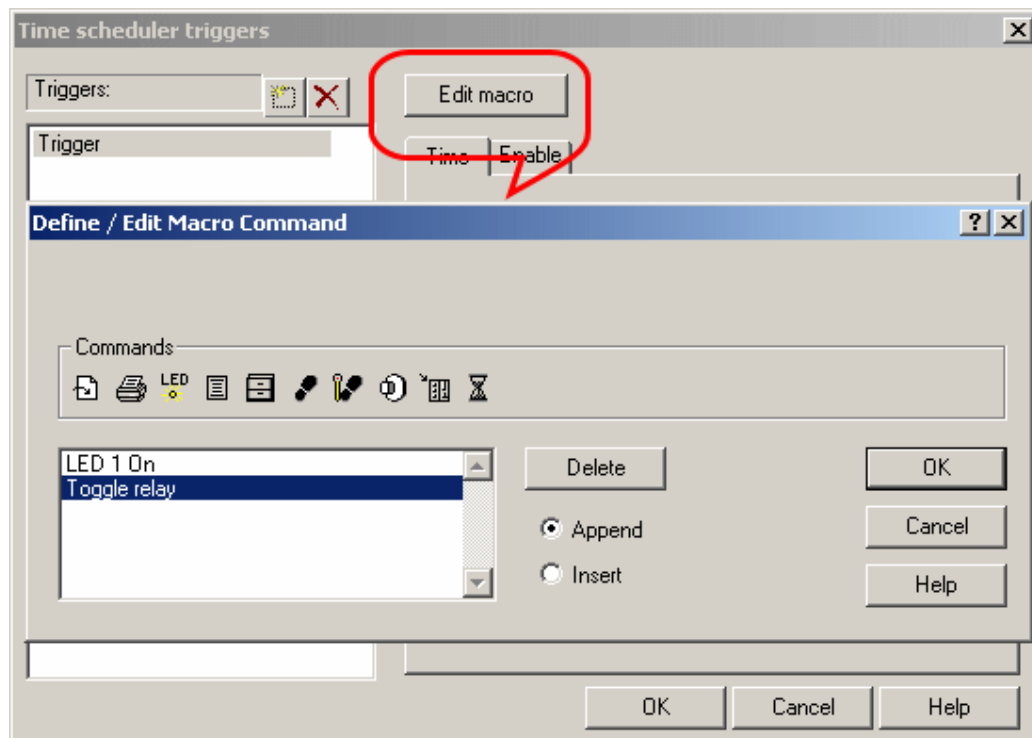

Time Tab



From the Time tab it is possible to specify any of the following trigger type.

- Yearly
- Weekly
- Daily
- Hourly
- Single Shoot
- Every (Interval time)

## Enable Tab

From the Enabled tab it is possible to define the time window when the trigger is enabled. By default, the Enable checkbox is not checked, the trigger is always enabled.

When the Enabled check box is checked, the trigger is enabled only inside the time windows specified inside this dialog box.

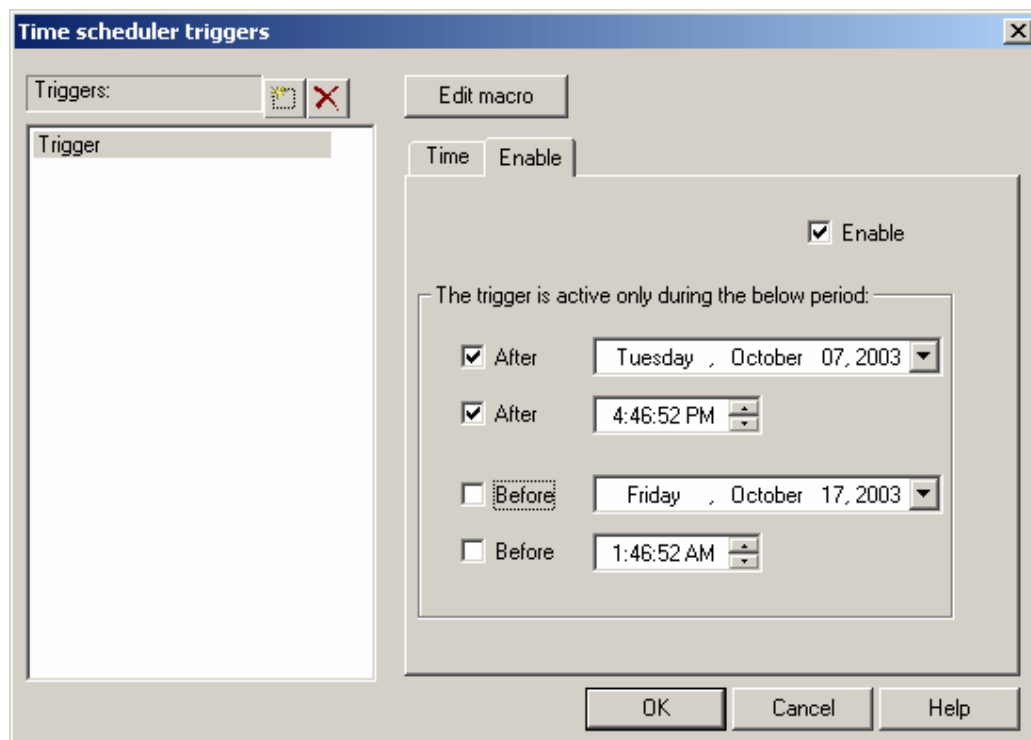

### After Date - Before Date

When only the “after date” and the “before date” are checked the trigger is active only inside the two defined days.

### After Time - Before Time

When only the “after time” and the “before time” are checked the trigger is active all days but only when time is between the two defined time values.

### After Date - Before Date - After Time - Before Time

When all four parameters are defined the trigger is active only after the defined After Date and After Time until the defined Before Date and Before Time.

#### After Date

When only the single “After date” parameter is defined, the trigger is active all days after the specified day.

#### After Time

When only the single “After time” parameter is defined, the trigger is active all days after the specified time.

#### Before Date

When only the single “Before date” parameter is defined, the trigger is active all days until the specified day.

#### Before Time

When only the single “Before time” parameter is defined, the trigger is active all days until the specified time.

#### After Date - After Time

When “After date” and “After time” parameters are defined the trigger is active all days starting from the specific time and date.

#### Before Date - Before Time

When “Before date” and “Before time” parameters are defined the trigger is active all days until the specific time and date.

#### Time Scheduler Control Variables.

To be able to edit the trigger parameter values from the panel operator, it is necessary to put the desired trigger parameters on a panel page using the new Time Scheduler Control variables as shown in the below figure.

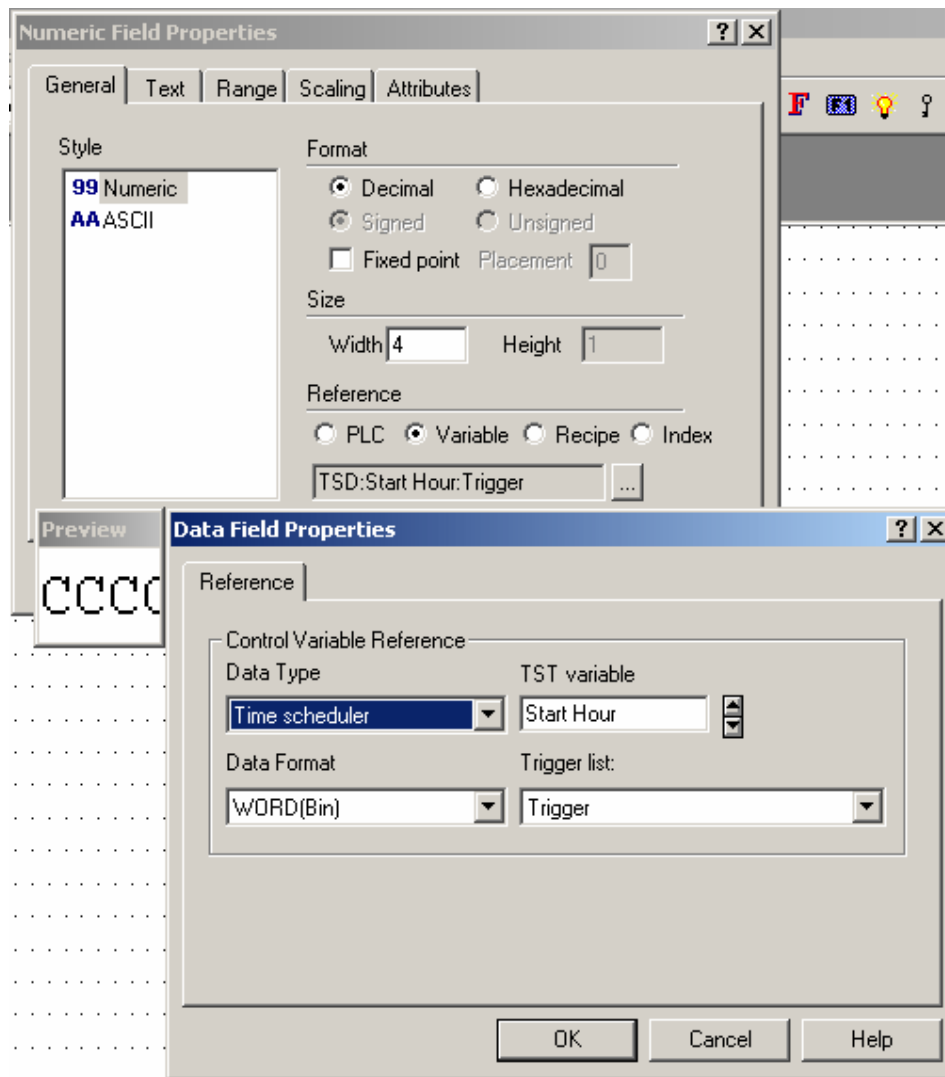

## 4.7 Transfers Menu

### 4.7.1 Transfers Menu

This section provides information about the Transfers menu. Options in the Transfers menu let you set the parameters to communicate with a target system (panel). Control functions that can be performed from the Transfers menu include:

Download,

Upload,

Download to SSFDC,

Get Panel Resources,

Check Firmware Versions,  
Switch to Operation mode,  
Remote Passthrough,  
Dial, and  
Hang Up;  
plus various transfer Options may be set.

To communicate with a panel, you must have:

The Designer software installed correctly

The Designer communication cable connected between the PC and the panel

The correct communications parameters set

The panel placed in configuration mode

## 4.7.2 Download

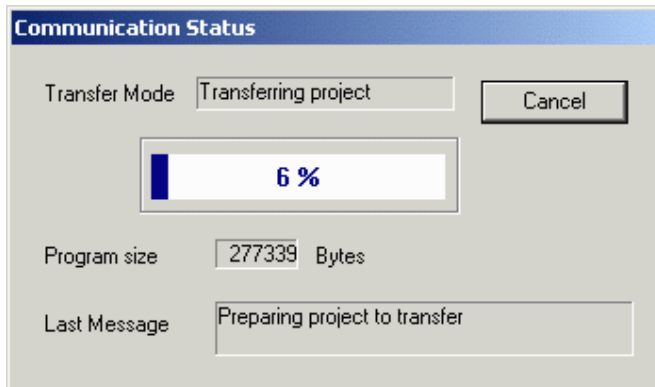

This lets you transfer the project file from the computer to the operator interface panel. You can choose this option by selecting Download from the Transfers menu, by clicking on the Download icon in the toolbar, or by pressing the F2 key.

Note: The panel must be in Configuration Mode in order for the download procedure to work.

### 4.7.3 Upload

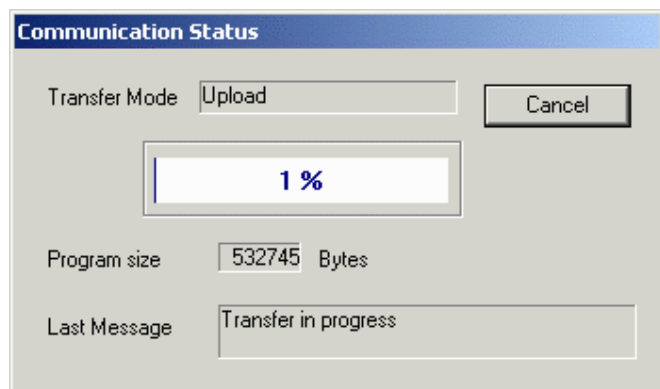

Selecting this option lets you upload an existing application from the target system memory into PC workstation memory. As this will erase the application that is currently loaded in the Designer software, you will be prompted to confirm the operation.

You can choose this option by either selecting Upload from the Transfers menu, by clicking on the Upload icon in the toolbar, or by pressing the F3 key.

### 4.7.4 Download to SSFDC

### 4.7.5 Download to SSFDC

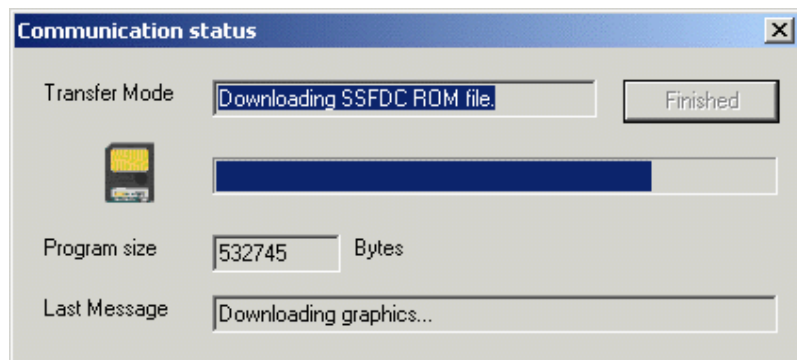

This command allows you to download a file to an SSFDC memory card, if one is installed. To download a file to an SSFDC card, select Download to SSFDC from the Transfers menu, or press the F6 key.

An explanation of SSFDC error codes is provided.

## 4.7.6 SSFDC Error Codes

### 4.7.7 UniOP SSFDC Error Codes

This section contains a description of the error codes displayed by the UniOP MMI products when the panel cannot go into Operation Mode for any reason. The Bootstrap module of UniOP firmware includes a diagnostic system very useful for determining why a UniOP panel stays in Operation Mode without apparent reason.

Note: This diagnostic service is available only in products with firmware type 38 and 58 with SSFDC memory card.

### 4.7.8 Displaying SSFDC Error Codes

During the system start-up phase, the UniOP firmware checks the contents of the flash memory to verify its integrity. When something goes wrong in this phase and a valid application has not been recognized, UniOP cannot start Operation Mode and remains in Configuration Mode.

Once the panel is unexpectedly in Configuration Mode, the corresponding error code can be recalled. The error code will be displayed in the 3rd row of the display, below the text "Configuration Mode". To display the error code press the Enter key for more than 2 seconds.

### 4.7.9 List of Error Codes

There are a number of reasons why a panel does not enter normal Operation Mode as expected. The following table lists the possible the error codes.

All the error codes in the table are in hexadecimal format. If more that one condition is verified the corresponding code is the sum of the single codes.

Error Code	Description	Causes
0001	The SSFDC header is missing	The format process of the SSFDC card was not completed successfully. The card should be reformatted by downloading the project again or by using the Format Utility with the SSFDC Programmer software.
0002	Graphic file in the project is missing	Graphic information in the downloaded file is missing. The option Download Graphics should not be inactivated the first time a project is downloaded.
0004	Project file is missing	Project information in the downloaded file is missing. The option Download Protocol Only should not normally be used when downloading Designer projects.

0008	Application file is missing	Communication protocol in the downloaded file is missing. The project should be completely downloaded again or the option Download Protocol Only should be used.
0010	Project and graphic file do not match; they have different time reference	The last download was probably done with the option Download Graphics inactivated, but the graphic information has changed in the Designer project. The file should be completely downloaded again. The hardware /software consistency should also be checked.
0020	SSFDC card is not present	The memory card is not present or it is not correctly inserted.
0040	The downloaded project file supports different hardware type	The project is the memory requires different hardware.
0100	The firmware is missing in the panel	Only the Bootstrap software module is loaded in UniOP. The firmware is either missing or it is damaged.
0200	Communication session is in progress	Attempting to go into Operation Mode during a project file download. This happens if the Enter key is pressed during the download process.
0400	Bad checksum in the project	The global consistency checks of the downloaded project failed. The project should be downloaded again.
0800	Wrong application type or it does not match the project file	The protocol present in the memory card is not consistent with the downloaded project. This could happen if a project is downloaded with the option Download Project Only activated without erasing the previous protocol still present in the memory.
1000	MIPS FW code (Graphic Engine) is missing	The MIPS part of the FW code on the card is missing, corrupted, or not compatible with 8051 FW. This error is possible only on boards using MIPS (T2000 or later).

## 4.7.10 Options

### 4.7.11 Options

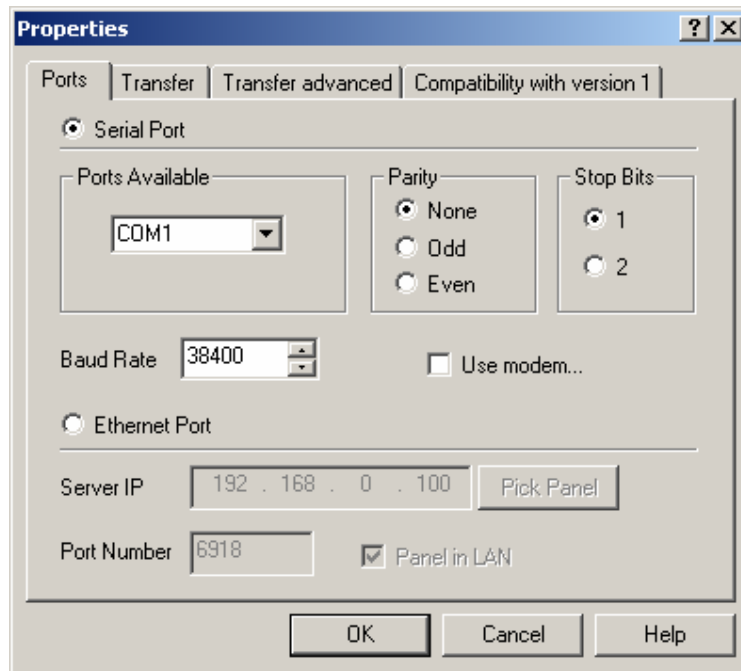

Selecting Options from the Transfers menu lets you choose the panel memory location for both the project and the protocol, and set communication parameters display preferences. Tabs in the Options Properties dialog box include:

Serial Ports, Ethernet Port

Transfer,

Transfer advanced,

Compatibilby with Version 1,

Modem commands, and

Modem messages.



## 4.7.12 Serial Ports

### 4.7.13 Ports

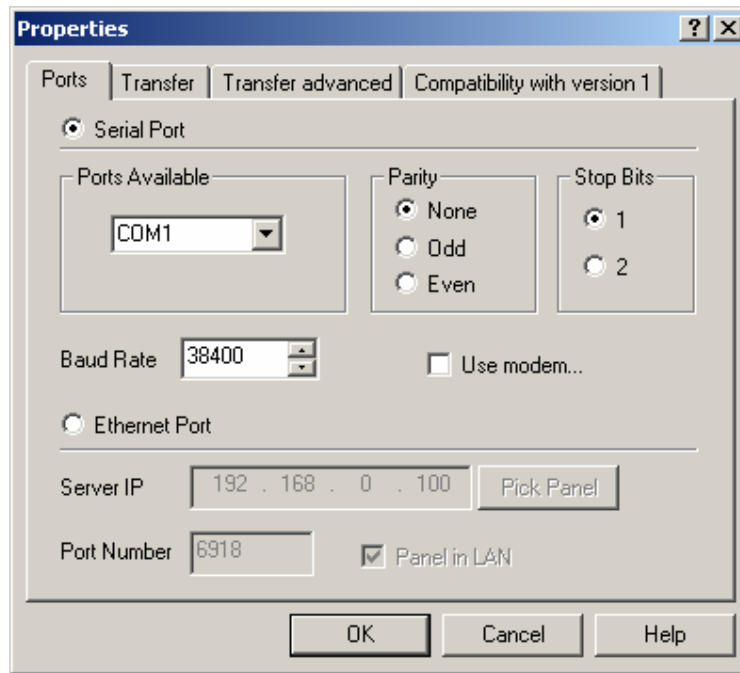

The communications parameters between Designer and the UniOP panel are set during installation. However, they should be checked by selecting the Ports tab under Transfers - Options. From this tab you can configure the ports to be used, the parity and stop bits, whether a modem is used to communicate with the panel, and the baud rate.

Unless otherwise noted, communication is possible with all panel models by setting the following parameters:

Baud	38400*
Data Bits	8
Parity	None
Stop Bits	1

\* Not all panels are capable of communicating at this speed.

### 4.7.14 Ports Available

Indicate the PC port to be used for communication with the panel.

When Designer is started, it first checks to see if the requested COM port is available. If the requested COM port is currently occupied by some other program, Designer will automatically switch to the next available port. When this occurs, a message box will appear explaining the conflict and the action taken.

#### 4.7.15 Parity

Specifies the parity to be used in communication between the target panel and Designer.

#### 4.7.16 Stop Bits

Specifies the number of stop bits to be used in communication between the target panel and Designer.

#### 4.7.17 Use Modem

Check the box if communication with the panel is to be via modem.

#### 4.7.18 Baud Rate

This option specifies the baud rate to be used in communication between the target panel and Designer.

#### 4.7.19 Transfer

#### 4.7.20 Transfer

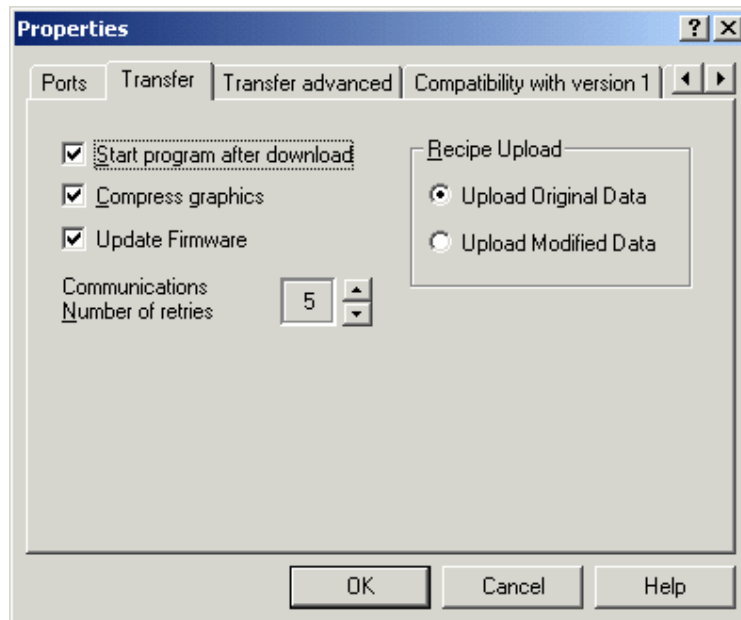

The Transfer tab contains commands pertaining to communications between your PC and the UniOP panel. These include:

Start Program After Download,  
Compress Graphics,  
Communications Number of Retries,  
External Memory Types,  
Update Firmware,  
Memory Location for Project, and  
Recipe Upload.

#### **4.7.21 Start Program After Download**

Automatically starts a program on a panel after download.

#### **4.7.22 Compress Graphics**

Compresses graphics during transfer. This makes for faster communications but can have a detrimental effect on certain types of graphics.

#### **4.7.23 Communications Number of Retries**

The number of times Designer will try to establish a connection with a panel.

#### **4.7.24 External Memory Types**

Select the type of external memory being used.

Note: This option is only available when external memory is specified under Configure Controllers in the Project menu.

#### **4.7.25 Update Firmware**

It is possible to update the firmware on some panels by checking this box. Some UniOP panels are able to accept new firmware files through the serial line or through the SSFDC memory card. For these panel models, the firmware files can be stored in the SSFDC memory card.

The setup procedure installs a firmware subdirectory inside the Designer working directory. This directory contains all the necessary firmware files used by Designer to check and update the panel SSFDC memory card. New firmware files have to be copied inside this directory to be accessible from Designer.

Note: A special key sequence is necessary to complete the firmware update. This special key sequence ensures that inexperienced users cannot update the panel firmware unintentionally.

Note: Designer checks the firmware version before beginning any download operation. When an old firmware file version is detected inside the panel, a dialog box is displayed to give you a chance to upgrade the firmware file.

## 4.7.26 Memory Location for Project

Indicate whether the project will be stored on internal panel memory, such as an SSFDC card, or on a memory device external to the panel.

## 4.7.27 Recipe Upload

Indicate whether original or modified data is to be used during recipe upload.

## 4.7.28 Transfer Advanced

## 4.7.29 Transfer Advanced

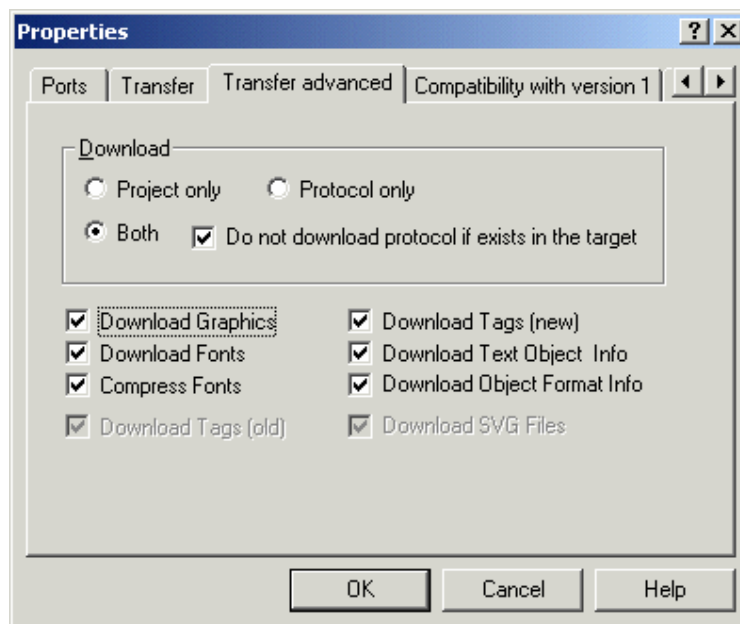

The Transfer Advanced tab lets you select the memory location for the protocol, download/compress options, and whether to download the project, the protocol, or both.

## 4.7.30 Memory Location for Protocol

Specify whether the memory location for the protocol is internal or external to the panel, or in the firmware.

### 4.7.31 Download

You can choose to download the project, the protocol, or both. If Both is selected, you have the option to not download the protocol if it already exists in the tar file, as a precaution.

### 4.7.32 Download Compress Options

Select whether graphics, fonts, tags, and/or object information are to be downloaded, and whether fonts are to be compressed during downloading.

### 4.7.33 Compatibility with version 1

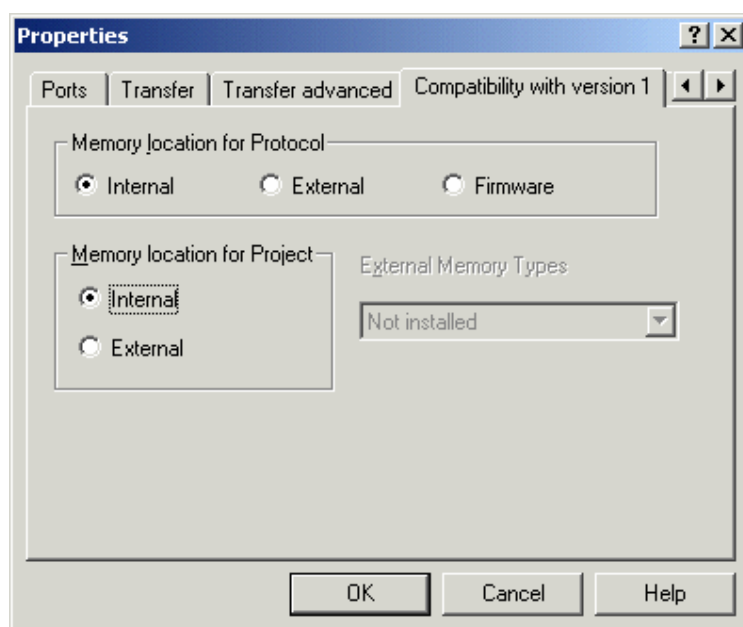

The Compatibility with version 1 tab lets you create projects that are compatible with the old version 1 of the UniOP panels.

In the current UniOP panels the project file and the code handling the communication protocols are stored in the same memory.

In old UniOP panels it was possible to specify the target memory location for both the protocol code and the project data. Of course the available options were depending on the actual hardware configuration.

In the above dialog, internal memory means Battery backed RAM and external memory means Flash or EPROM.

In particular UniOP models the protocol code was part of the panel firmware and could not be changed nor modified.

### 4.7.34 Modem Commands

The Modem commands tab is only visible if Use modem is selected on the Ports tab under Transfers - Options.

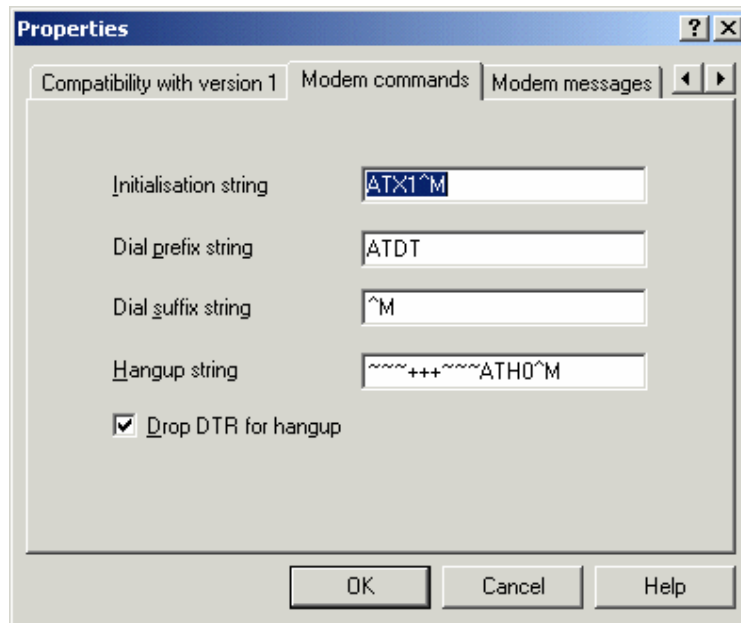

Selecting this feature lets you specify modem settings, such as initialization strings, dial or hangup strings, etc. Indicate if the DTR signal should be dropped for hangup.

### 4.7.35 Modem Messages

### 4.7.36 Modem Messages

The Modem messages tab is only visible if Use modem is selected on the Ports tab under Transfers - Options.

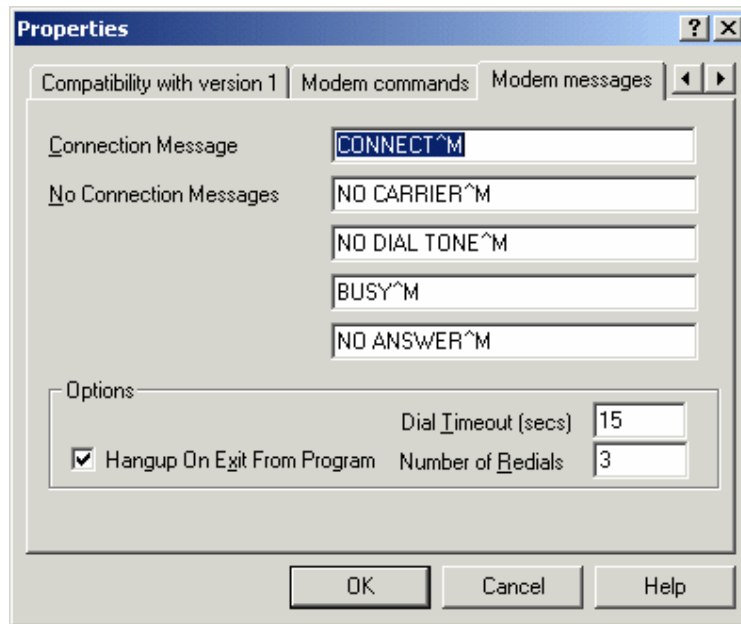

This tab contains entry boxes for a connection message and no connection messages, plus other modem options.

#### 4.7.37 Connection Message

Enter any necessary connection messages in the box provided.

#### 4.7.38 No Connection Messages

Enter any necessary messages in the case that no connection is established in the boxes provided.

#### 4.7.39 Options

#### 4.7.40 Options

Various modem options are available, including the dial timeout, the number of redials, and whether or hang up upon exiting Designer.

#### 4.7.41 Hangup

Check this box to have the modem hang up when the program is exited. This prevents unnecessary use of the modem.

## 4.7.42 Dial Timeout

Set the timeout, in seconds, if a successful dial is not achieved.

## 4.7.43 Number Redials

Set the number of automatic redials.

## 4.7.44 Get Panel Resources

Before beginning work on a particular project, you need to specify the type of display that the target panel contains. The physical size of the screen, as well as its type (backlight LCD, passive color) must be specified. Failure to do this accurately may result in the loss of text and data whenever an attempt is made to download a project file to the panel.

The Get Panel Resources feature is provided to help set the parameters for the target panel quickly or to determine unknown information about the connected panel. This option may be selected from the Transfers menu, by clicking on the Get Panel Resources icon in the toolbar, or by pressing the F4 button. In order to use this feature, the target panel must be connected to the PC and the panel must be in Configuration Mode. Upon selecting this item, Designer will attempt to retrieve the connected panel's configuration.

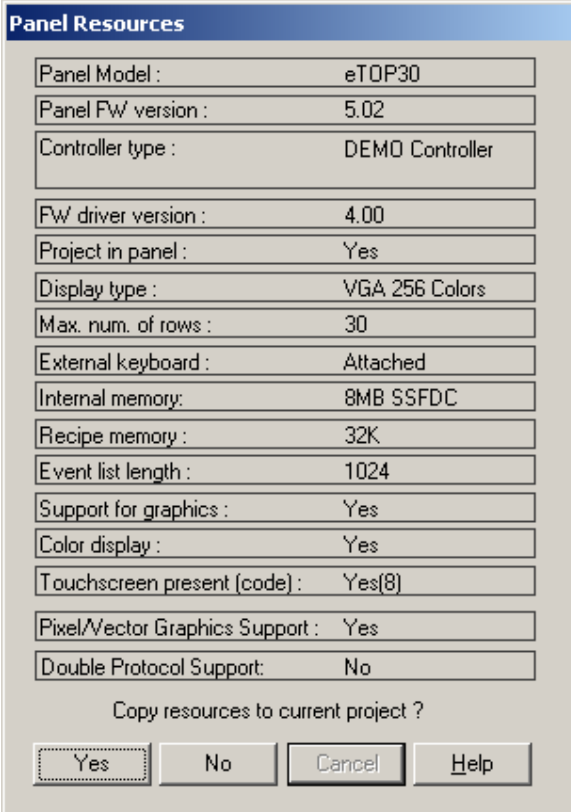

The screenshot shows a dialog box titled "Panel Resources" with a list of parameters and their values. At the bottom, there is a question "Copy resources to current project ?" and four buttons: "Yes", "No", "Cancel", and "Help".

Parameter	Value
Panel Model :	eTOP30
Panel FW version :	5.02
Controller type :	DEMO Controller
FW driver version :	4.00
Project in panel :	Yes
Display type :	VGA 256 Colors
Max. num. of rows :	30
External keyboard :	Attached
Internal memory:	8MB SSFDC
Recipe memory :	32K
Event list length :	1024
Support for graphics :	Yes
Color display :	Yes
Touchscreen present (code) :	Yes(8)
Pixel/Vector Graphics Support :	Yes
Double Protocol Support:	No

Copy resources to current project ?

Yes No Cancel Help

When successful the following information is displayed.



Panel Model:	The panel model.
Panel FW version:	The panel firmware version.
Controller Type:	Internal code to identify the type of controller.
FW driver version:	Version of the controller driver being used.
Project in panel:	Reports if there is a project file in the panel.
Display type:	Type of display.
Max num of rows:	Number of rows per project page.
External keyboard:	Whether or not a keyboard is present.
Internal memory:	Amount of memory available for project file.
Recipe memory:	Amount of memory available for recipes.
Event list length:	Number of events that can be stored in Event list.
Support for graphics:	If the panel is capable of supporting graphics.
Color display:	If the panel contains a color display.
Touchscreen present (code):	If the panel has a touchscreen (and the internal code, if present).
Pixel/Vector Graphics Support:	If the panel is capable of supporting Pixel/Vector Graphics.
Double Protocol Support:	If the panel is capable of Double Protocol Support.

You may copy the displayed resource configuration to the current project by pressing the Yes button. If you do not wish to use the reported parameters, press No.

If for any reason Designer is unable to communicate with the panel, a message box will appear explaining the problem.

It is also possible to manually configure the software by using Panel Setup from the Project menu.

#### 4.7.45 Check Firmware Versions

Correctly setting the Firmware Download flag is necessary to give Designer the necessary information required to correctly calculate the SSFDC memory used, taking into account the size of the firmware files.

After exchanging information with the panel to detect the version of the firmware files that are inside the SSFDC memory card, a dialog box is displayed.

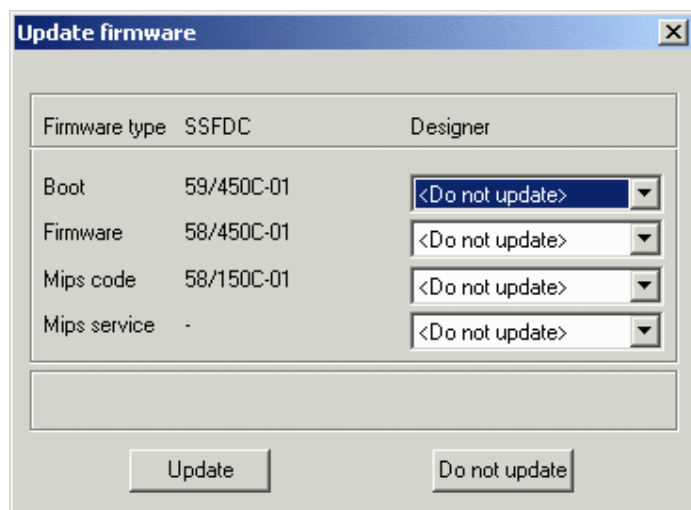

The left column displays the versions of the firmware files that are located in the SSFDC memory card. The right column displays versions of firmware files only if your computer contains a newer version. If a newer version is not detected, <Do not update> is displayed.

#### 4.7.46 Switch to Operation mode

Selecting this option causes the application in the panel's memory to begin running.

Note: Communication with the panel is interrupted until the panel returns to Configuration Mode.

#### 4.7.47 Switch to Configuration mode

Selecting this option causes the panel to switch to Configuration mode.

#### 4.7.48 Remote Passthrough

#### 4.7.49 Remote passthrough

This entry lets you select one of three remote passthrough commands: Configuration Mode, Start or Stop.

This feature lets you remotely put a UniOP panel into either Configuration Mode or Operation Mode via a modem. In this manner, you can remotely upload or download a project file, start the panel, or use passthrough mode to access the programming port on the PLC.

Note: The UniOP panel must contain firmware version 4.20 or later to use this feature.

Note: The Remote passthrough commands are active only when Remote Hardware mode has been selected under the Passthrough tab of Project - Panel Setup.

### 4.7.50 Configuration Mode

If no project file has been downloaded to the panel, the panel will default to Configuration Mode when power is applied.

To re-enter Configuration Mode after the panel is in operation, press and hold the Enter key for a few seconds. The System Menu will appear. Use the arrow keys on the display panel to highlight the CONFIG selection in the top right-hand corner of the menu and press Enter.

Note: If the Enter key is not available, touch and hold any open space on the touchscreen panel for several seconds. The System Menu should appear, listing the Configuration Menu as a selection. Use the arrow keys on the panel to select the Configuration Menu.

Note: If Configuration Mode is locked out, hold down three (3) arrow keys, power the unit down (continue holding down the three arrow keys), and power the unit back up. Make sure that the project file is saved before attempting this!

Note: Another method for accessing Configuration Mode from a touchscreen panel is listed below. Please note that not all touchscreen panels are capable of this "quick fix". Make sure that the project file is saved before attempting this!

Begin tapping the center of the screen.

Power the unit down and back up (when you power it up continue tapping the center of the screen).

You should be prompted by the panel to touch a circle on a portion of the screen. Follow the panel directions. After completing the panel's instructions, press the Enter key displayed on the panel. (This process is sometimes difficult to complete, as the touchscreen is particular about the area pressed. You may have to do this procedure more than once to get it to work.) This should activate Configuration Mode.

Note: If a project that uses passwords is locked out of Configuration Mode, enter 0007 as the password. This should allow access to Configuration Mode.

### 4.7.51 Start

This transfers a start command to the panel.

### 4.7.52 Stop

This transfers a stop command to the panel.

### 4.7.53 Dial

This feature lets you enter a phone number and send a dial command to your modem. By using the Add Entry and Delete Entry buttons, you may add commonly used numbers to a phone directory for reference, and delete numbers when they are no longer needed. Click on the Start Dialing button to initiate dialing by your modem.

#### **4.7.54 Hang Up**

This feature lets you send a hang-up command to your modem.

### **4.8 Tools Menu**

#### **4.8.1 Tools Menu**

The Tools menu contains commands to help you to customize the appearance of the toolbars, grid, and font that appear on the screen.

Tag Editor

Font Editor

Keypad Designer

Customize

Options

Advanced

Replace Image(s)

#### **4.8.2 Tag Editor**

#### **4.8.3 Tag Editor**

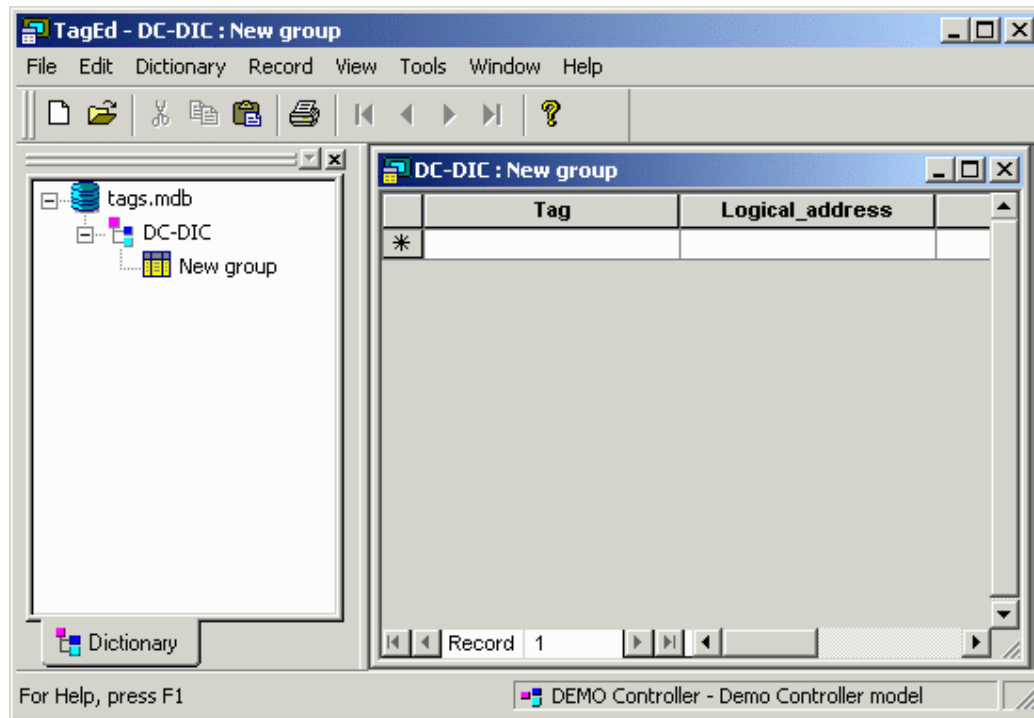

Tags allow mnemonic reference to PLC variables. A thorough discussion of the use of tags is available.

The Tag Editor allows you to easily work with a large number of tags by creating a tag database for your project. It provides the capability to add, delete and modify tags as well as assign PLC addresses to each tag, plus it includes import and export capabilities to exchange tags with external applications. You can create a list of tag names in the Tag Editor and then assign the tag names to various fields of the Designer project by simply selecting a tag name.

The Tag Editor provides a grid-like user interface where you can enter a tag name, assign a tag address, a group name for the tag, and enter a comment for the tag.

An example of using tags and the Tag Editor is available.

To open the Tag Editor, select Tag Editor from the Tools menu of Designer. The Tag Editor application opens. The Tag Editor is a typical Windows™ application with menus across the top, a workspace to on the left side, and the currently open file shown on the right.

#### 4.8.4 File Menu

#### 4.8.5 File Menu

The Tag Editor File menu includes commands for managing tag dictionaries, such as:

New

Open  
Save As  
Import Tags  
Export Tags  
New Dictionary  
New Group  
Delete Dictionary  
Print  
Print Preview  
Print Setup  
Recently Opened Files  
Exit

#### 4.8.6 New

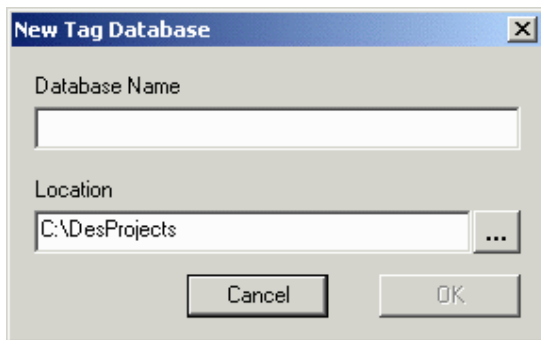

Selecting New from the File menu of the Tag Editor opens the New Tag Database dialog box. From this box you can name a new database and specify its location. Click the "..." button next to Location if you want to store the database file in another folder or drive.

### 4.8.7 Open

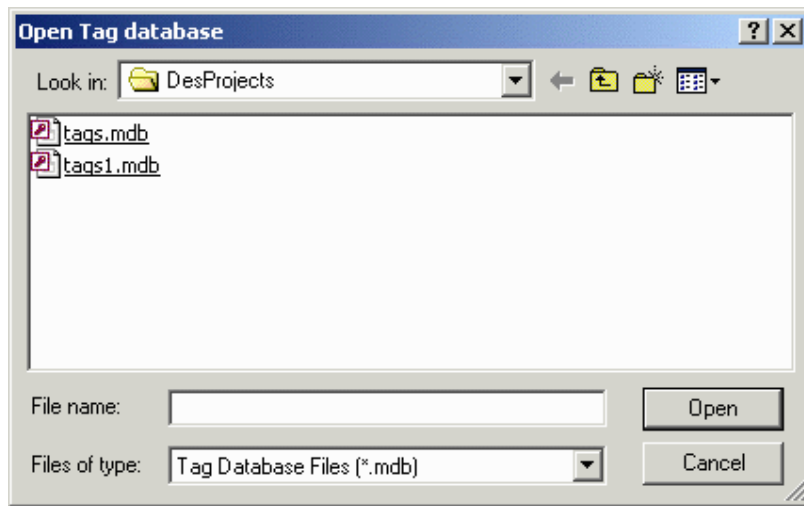

This familiar Windows™ box allows you to choose a file to open in the Tag Editor. Tag database files are normally in the format \*.mdb. The selected database will appear in the workspace on the left of the page.

### 4.8.8 Save As

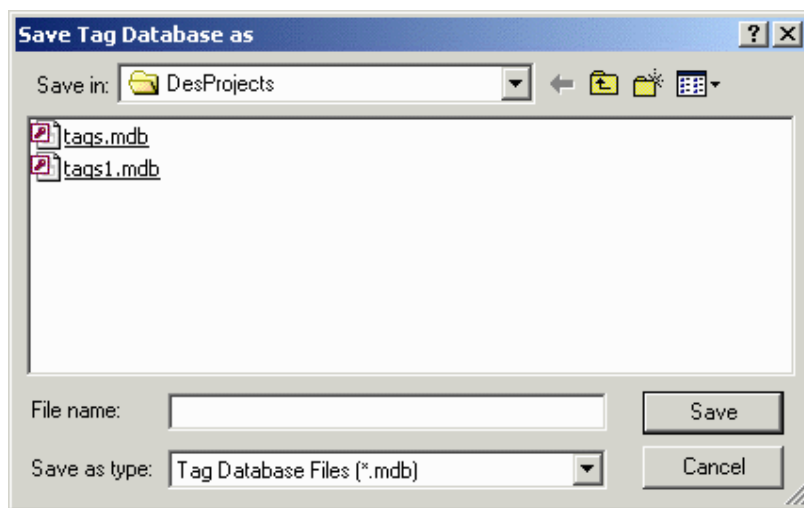

This familiar Windows™ box lets you save a file in the Tag Editor. Enter a file name and specify where the file is to be saved.

## 4.8.9 Import Tags

### 4.8.10 Import Tags

It is possible to import tags from external sources such as an Excel™ database. Select Import Tags from the File menu of the Tag Editor and the Tag Import Wizard steps you through the process. <Back and Next> buttons help you navigate through the process. A Cancel button is available if you want to exit the Tag Import Wizard.

A Help button provides access to help text about the Tag Import Wizard.

### 4.8.11 Import Tags Step 1

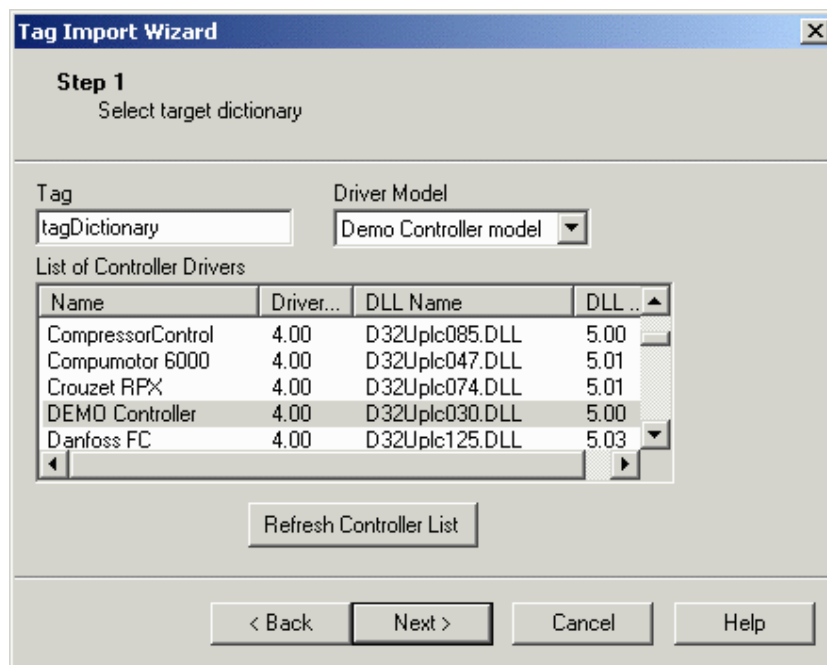

Enter a name for the new tag dictionary in the Tag box. Select a controller driver from the list. Select a particular driver model, if necessary.

The Refresh Controller List button is available if it is necessary to refresh the list for any reason.

When you have completed Step 1, click the Next> button to continue to Step 2.



#### 4.8.12 Import Tags Step 2

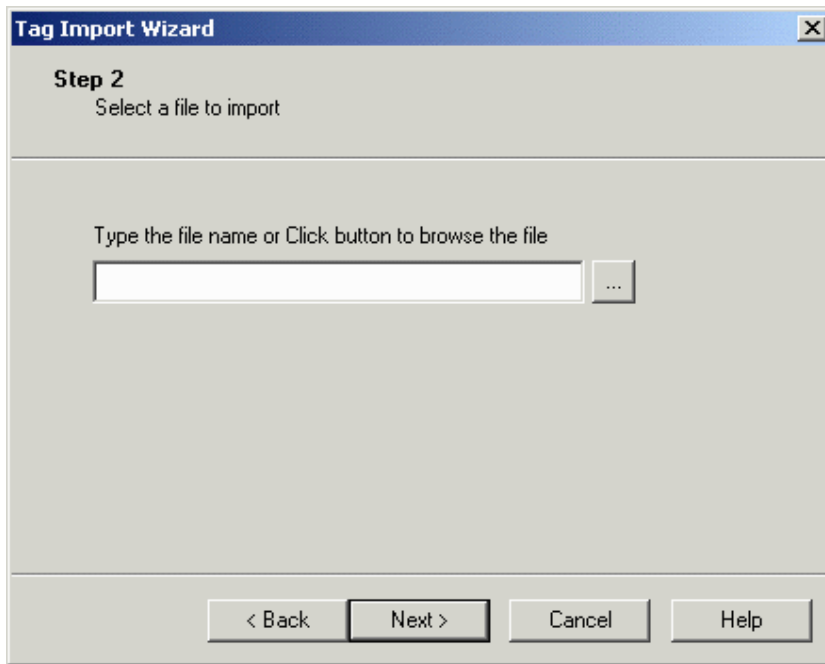

In Step 2 you will select the file that you wish to import.

If you know the file name you can enter it in the box. Otherwise, click on the "..." button to browse the system. When you locate the file that you want to import, click on the file name to select it, then click the Open button. You are returned to the Tag Import Wizard and the selected file name is entered in the box.

The following file formats are supported.

- Excel files (\*.xls)
- CSV files (Comma delimited) (\*.csv)
- CSV files (Semicolon delimited) (\*.csv)
- Text (Tab delimited) (\*.txt)

When you have completed Step 2, click the Next> button to continue to Step 3.

### 4.8.13 Import Tags Step 3

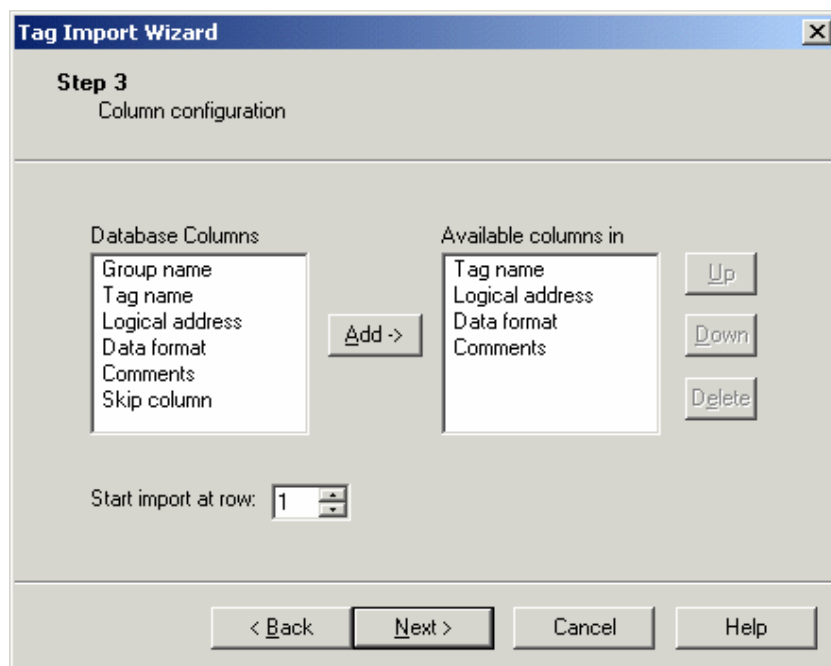

In Step 3 you will configure the columns in your imported files. In the left box are the columns available in the database being imported.

Specify the value in the edit box of 'Start import at row' in order to specify the first row of the data user want to import.

You may need to scroll to see all of the available column names. In the right box are the columns normally available in a tag database. If you want to add columns to this list, you may do so. Simply click on a column name in the left box and click the Add-> button. The column name appears in the right box.

Column names are appended to the bottom of the list. Select a column name and use the Up and Down buttons to rearrange the list order, if necessary. If you change your mind, the Delete button will remove a column from the list.

When you have completed Step 3, click the Next> button to continue to Step 4.

### 4.8.14 Import Tags Step 4

(For excel import only)

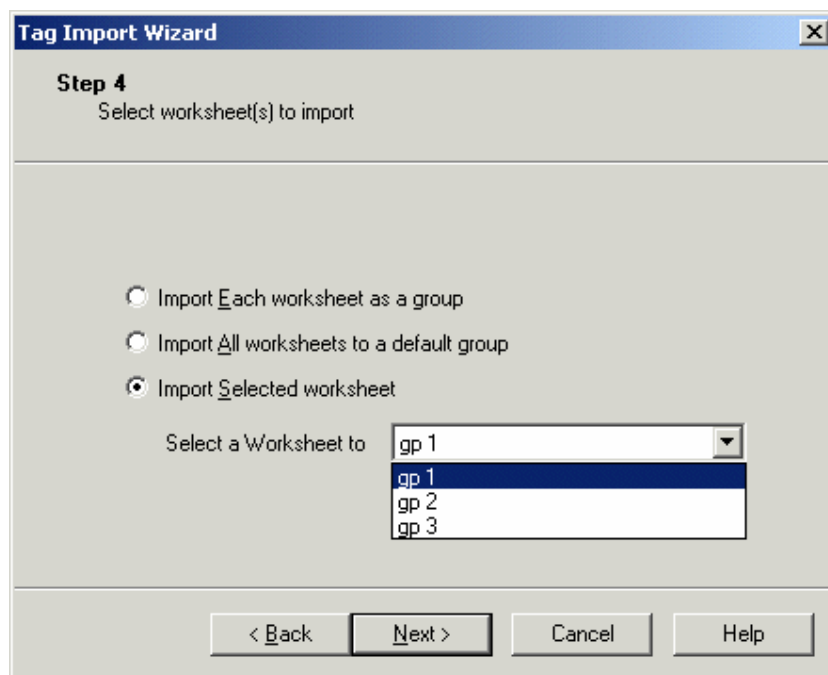

If the imported file has more than one worksheet the user is given three choices as shown in the above dialog. This is applicable only to .xls file format. For all other format this step is skipped.

When you have completed Step 4, click the Next> button to continue to Step 5.

#### 4.8.15 Import Tags Step 5

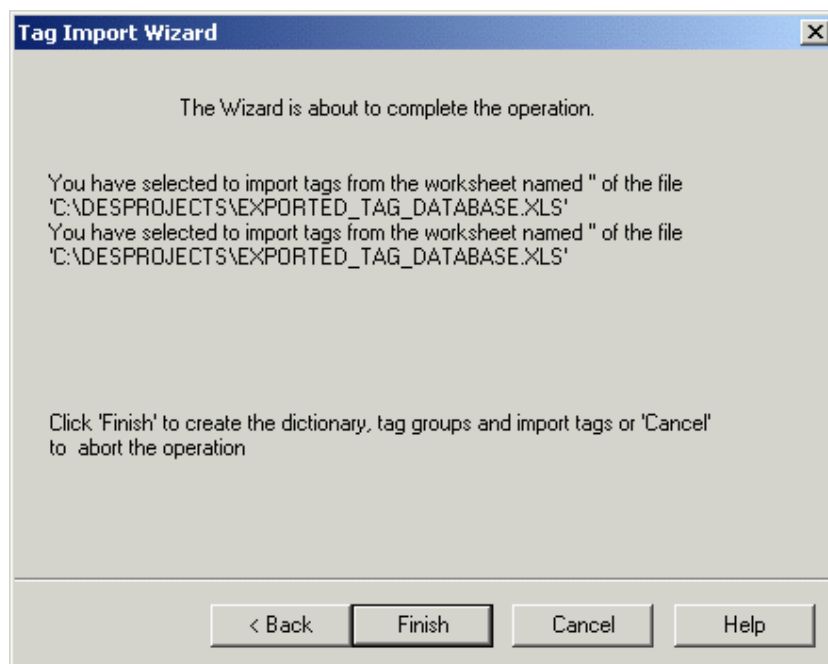

The final step of the Tag Import Wizard is to create the dictionary and tag groups, and to import the tags.

Verify the location from which the tags are being imported, and click the Finish button to complete the operation.

A confirmation message will appear. Click OK.

#### 4.8.16 Export Tags

#### 4.8.17 Export Tags

It is possible to export tags for use in another application. Select Export Tags from the File menu of the Tag Editor and the Tag Export Wizard steps you through the process. <Back and Next> buttons help you navigate through the process. A Cancel button is available if you want to exit the Tag Export Wizard.

A Help button provides access to help text about the Tag Import Wizard.

#### 4.8.18 Export Tags Step 1

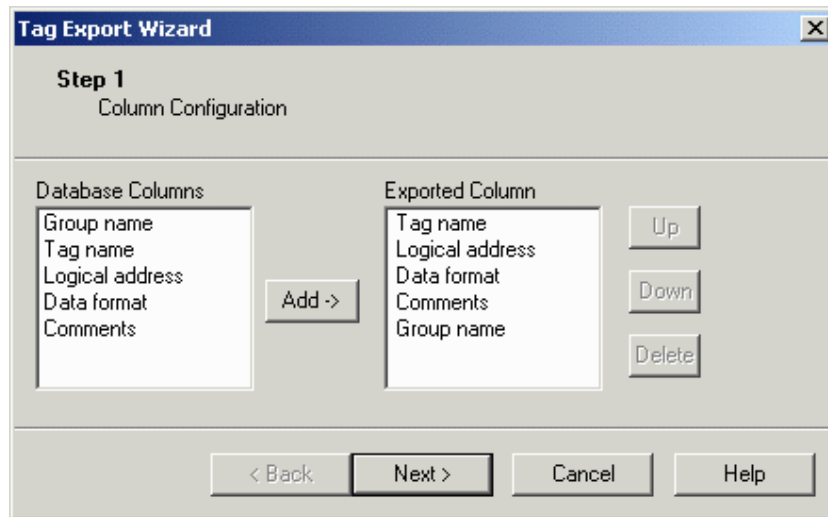

In Step 1 you will configure the columns to be exported. In the left box are the columns available in the database being exported. You may need to scroll to see all of the available column names.

In the right box are the columns normally exported. If you want to add columns to this list, you may do so.

Simply click on a column name in the left box and click the Add-> button. The column name appears in the right box.

Column names are appended to the bottom of the list. Select a column name and use the Up and Down buttons to rearrange the list order, if necessary.

If you change your mind, the Delete button will remove a column from the list.

When you have completed Step 1, click the Next> button to continue to Step 2.

#### 4.8.19 Export Tags Step 2

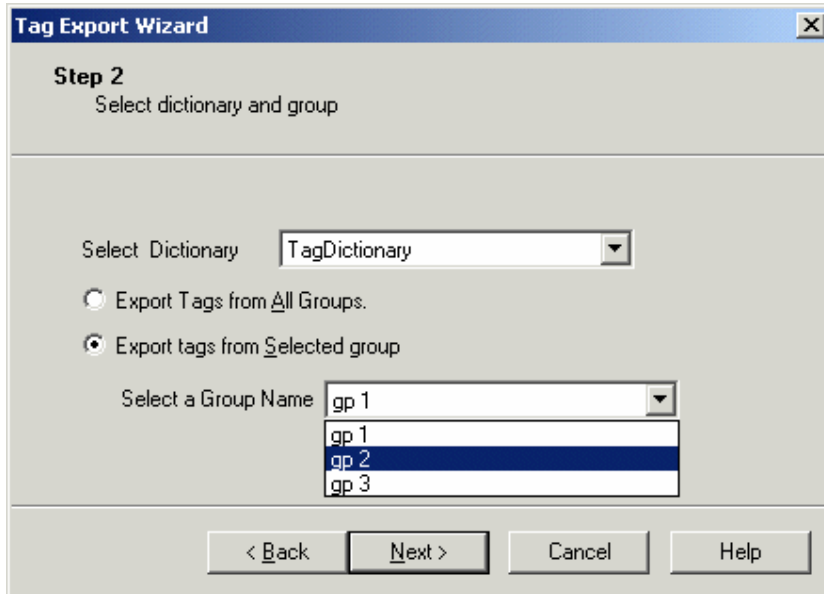

In Step 2, select the dictionary to be exported.

If the selected dictionary has more than one group associated with it then user has the option to export tags from all groups or to export tags from selected group.

When you have completed Step 2, click the Next> button to continue to Step 3.

## 4.8.20 Export Tags Step 3

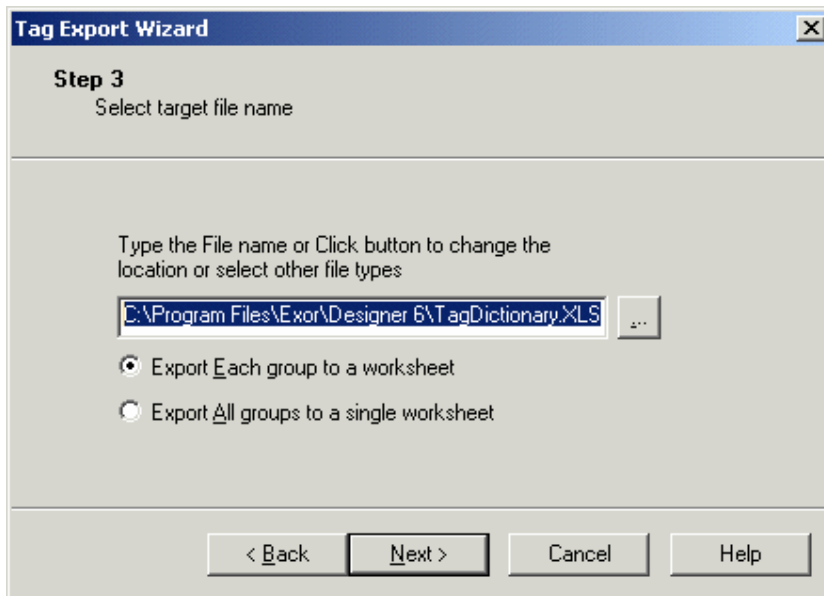

In Step 3, select a name for the exported file. A default name is already entered in the box. If you wish, enter a different name in the box, or click the "... " button to bring up the Save As box.

If the user has selected the option 'Export tags from all groups' in the second step of export wizard then the user is given the option to export each group to a work sheet or export all groups to a single work sheet. This is applicable only to .xls file format.

When you have completed Step 3, click the Next> button to continue to Step 4.

## 4.8.21 Export Tags Step 4

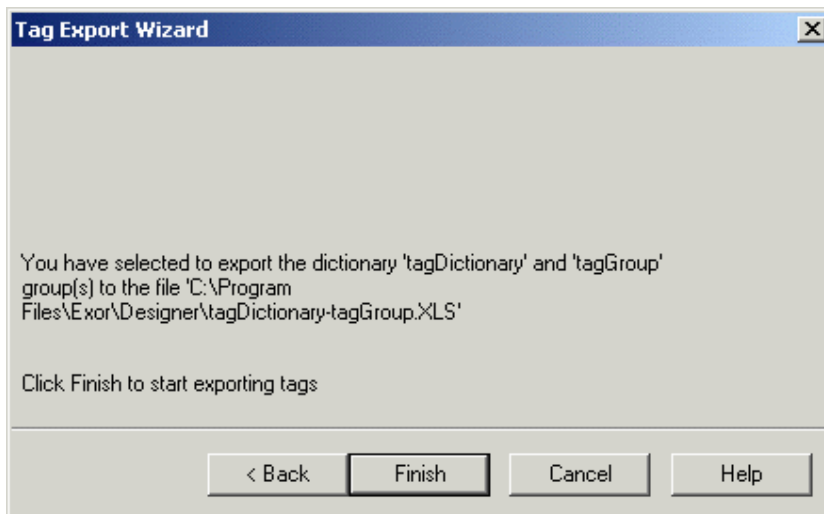

In the final step you are asked to confirm the dictionary to be exported. If the information is correct, click the Finish button the export the tags.

The exported file will be saved in the location and with the file name that you specified.

#### **4.8.22 New Dictionary**

The New Dictionary command is available from the Tag Editor File menu if no tag dictionaries are currently opened. If a tag dictionary is open, then the New Dictionary command is available under the Dictionary menu.

Selecting New Dictionary from the File or Dictionary menus, clicking on the New icon, or right clicking on a dictionary in the workspace and selecting New Dictionary, will open the New Tag Dictionary dialog box. In this box you name your new dictionary and associate it with a particular controller.

Enter a name for your new dictionary in the Tag Dictionary box. Select the controller driver that you plan to use from the list provided. If more than one driver model is available with the selected controller, select the model you plan to use from the list under Driver Model.

#### **4.8.23 New Group**

The New Group command is available from the Tag Editor File menu if no tag dictionaries are currently opened. If a tag dictionary is open, then the New Group command is available under the Dictionary menu.

The New group dialog box allows you to enter tag information. The particular columns available may vary, but will normally contain at least the tag name, the logical address for the tag, the data format for the tag, and any comments necessary.

Type a tag name in the Tag box and any comments in the Comment box. Clicking on the Logical\_address box activates an arrow. Click on the arrow to bring up the Data Field Properties dialog box. Specify the reference address, data type and format, etc. Click OK to return to the New group dialog box with the logical address and data format information completed.

Every time you enter information on one line, an additional line appears below it. Fill in as many lines as you need. When you have entered all the information in the New group dialog box, select Save As from the File menu to save the dictionary.

#### **4.8.24 Delete Dictionary**

This command deletes the selected dictionary.

#### **4.8.25 Print**

The Print command in the File menu allows you to print the currently open Tag Database.

Selecting Print from the File menu (or pressing the Ctrl+P keys) brings up the familiar Windows™ Print dialog box.

#### **4.8.26 Print Preview**

Selecting Print Preview from the File menu brings up the familiar Windows™ Print Preview view, from which the Tag Database may be previewed for printing.

#### **4.8.27 Print Setup**

Selecting Print Setup from the File menu brings up the familiar Windows™ Print Setup dialog box, from which printer properties may be selected.

#### **4.8.28 Recent Files**

The most recently opened files are listed under the File menu as a shortcut. Click on the name of a file to reopen it.

#### **4.8.29 Exit**

The Exit command closes the Tag Editor application.

#### **4.8.30 Edit Menu**

#### **4.8.31 Edit Menu**

The Edit menu of the Tag Editor contains familiar Window™ commands for working with text and objects on the page. These include:

Undo

Redo

Cut

Copy

Paste

Find

Replace

#### **4.8.32 Undo**

The Undo command reverses the last action. This action can also be activated by pressing the Ctrl+Z keys.



#### **4.8.33 Redo**

The Redo command reapplies the actions that were previously canceled by the Undo command. This action can also be activated by pressing the Ctrl+Y keys.

#### **4.8.34 Cut**

The Cut command removes the selected item from the current page and places it on the Windows™ clipboard. This action can also be activated by pressing the Ctrl+X keys.

#### **4.8.35 Copy**

The Copy command makes a copy of the selected item from the current page and places it on the Windows™ clipboard. This action can also be activated by pressing the Ctrl+C keys.

#### **4.8.36 Paste**

The Paste command places items from the Windows™ clipboard onto the current page at the current position of the cursor. This action can also be activated by pressing the Ctrl+V keys.

#### **4.8.37 Find**

Enter the text for which you are searching into the box. Check the Match case box if you are looking for an exact match with regard to capitalization. Indicate whether you wish to search up or down from the current point.

#### **4.8.38 Replace**

Enter the text for which you are searching into the Find what box. Enter the text with which you wish to replace it in the Replace with box. Check the Match case box if you are looking for an exact match with regard to capitalization. Click the Find Next button to locate the next occurrence of the text in the Find what box. When the text is located, you can click the Replace button to replace only that instance, or click the Replace All button to replace every instance.

#### **4.8.39 Dictionary Menu**

#### **4.8.40 Dictionary Menu**

The Dictionary menu allows you to add a New Dictionary, a New Group, or to Delete a Dictionary. The commands on the Dictionary menu are available only when a dictionary is opened within the Tag Editor.

#### 4.8.41 New Dictionary

The New Dictionary command is available from the Tag Editor File menu if no tag dictionaries are currently opened. If a tag dictionary is open, then the New Dictionary command is available under the Dictionary menu.

Selecting New Dictionary from the File or Dictionary menus, clicking on the New icon, or right clicking on a dictionary in the workspace and selecting New Dictionary, will open the New Tag Dictionary dialog box. In this box you name your new dictionary and associate it with a particular controller.

Enter a name for your new dictionary in the Tag Dictionary box. Select the controller driver that you plan to use from the list provided. If more than one driver model is available with the selected controller, select the model you plan to use from the list under Driver Model.

#### 4.8.42 New Group

The New Group command is available from the Tag Editor File menu if no tag dictionaries are currently opened. If a tag dictionary is open, then the New Group command is available under the Dictionary menu.

The New group dialog box allows you to enter tag information. The particular columns available may vary, but will normally contain at least the tag name, the logical address for the tag, the data format for the tag, and any comments necessary.

Type a tag name in the Tag box and any comments in the Comment box. Clicking on the Logical\_address box activates an arrow. Click on the arrow to bring up the Data Field Properties dialog box. Specify the reference address, data type and format, etc. Click OK to return to the New group dialog box with the logical address and data format information completed.

Every time you enter information on one line, an additional line appears below it. Fill in as many lines as you need. When you have entered all the information in the New group dialog box, select Save As from the File menu to save the dictionary.

#### 4.8.43 Delete Dictionary

This command deletes the selected dictionary.

#### 4.8.44 Record Menu

#### 4.8.45 Record Menu

The commands in the Record menu are used to manage the records located in the New group dialog box. These commands include:

Next Record

Previous Record

First Record

Last Record

Delete Records

#### **4.8.46 Next Record**

The Next Record command is used for navigating between cells in the New group dialog box. This command moves you to the next cell.

#### **4.8.47 Previous Record**

The Previous Record command is used for navigating between cells in the New group dialog box. This command moves you to the previous cell.

#### **4.8.48 First Record**

The First Record command is used for navigating between cells in the New group dialog box. This command moves you to the first cell.

#### **4.8.49 Last Record**

The Last Record command is used for navigating between cells in the New group dialog box. This command moves you to the last cell.

#### **4.8.50 Delete Records**

The Delete Records command is used to delete all the records located in the New group dialog box.

#### **4.8.51 View Menu**

#### **4.8.52 View Menu**

The View menu allows you to customize the appearance of the Tag Editor. Commands include:

Workspace

Toolbar

Status Bar

#### **4.8.53 Workspace**

The workspace bar is located at the left side of the Tag Editor dialog box and displays any open tag databases. If Workspace is checked in the View menu, then the workspace is visible. If it is unchecked, then the workspace bar is hidden.

The workspace can be docked to a side of the Tag Editor or float in the main Tag Editor window. Right-click on any item displayed in the workspace brings to up a command list that controls docking. Additional commands provide shortcuts to create a new dictionary or hide workspace. (To make the workspace visible again, simply check Workspace in the View menu.)

#### **4.8.54 Toolbar**

The toolbar is located under the Tag Editor menu bar and contains icons as shortcuts for commonly used commands. If Toolbar is checked in the View menu, then the toolbar is visible. If it is unchecked, then the toolbar is hidden.

#### **4.8.55 Status Bar**

The status bar is located at the bottom of the Tag Editor dialog box and displays contextual information. If Status Bar is checked in the View menu, then the status bar is visible. If it is unchecked, then the status bar is hidden.

#### **4.8.56 Tools Menu**

#### **4.8.57 Tools Menu**

The Tools menu contains the commands Customize and Options, which allow you to set the toolbars and colors of the Tag Editor to your own preferences.

### 4.8.58 Customize

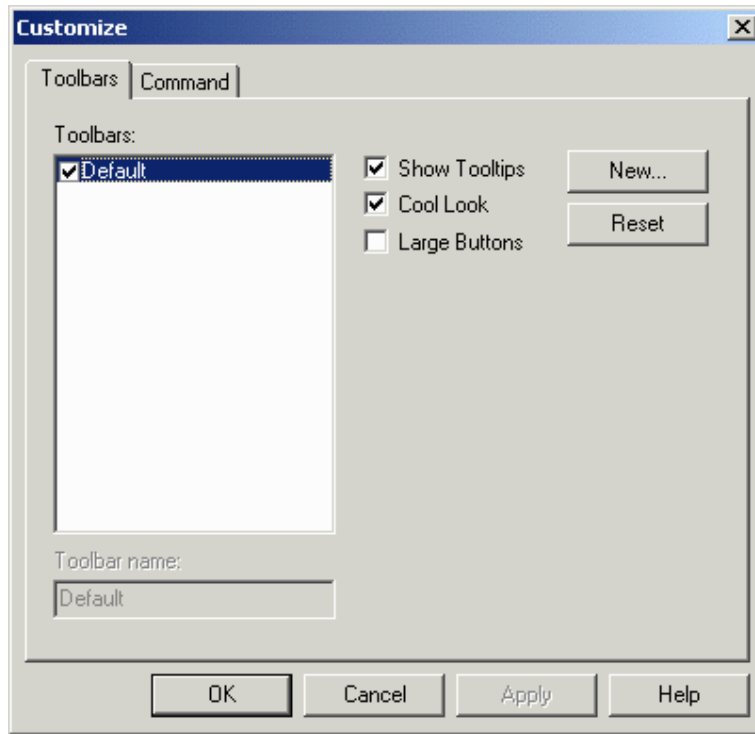

The commands on the Toolbars tab and the Command tab allow you to customize the appearance of the toolbars and the commands contained on the various toolbars within the Tag Editor.

### 4.8.59 Options

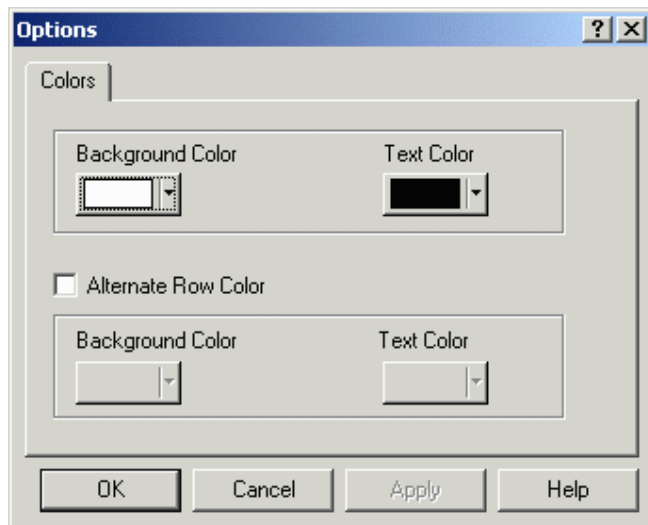

In the Options dialog box you can set text and background colors. To have alternating lines in different colors for improved readability, check the Alternate Row Color box and set the colors for the alternating row.

#### **4.8.60 Window Menu**

#### **4.8.61 Window Menu**

The Window menu contains familiar Window™ commands for managing multiple windows. These include:

New Window - opens a new window

Cascade - places each new window slightly below and to the right of the current window.

Tile - places each new window below the current window.

Arrange Icons - arranges the visible icons in an orderly manner

Close All - Closes all currently open windows.

File Identification - gives the file names of the files in the currently open windows.

#### **4.8.62 Help Menu**

#### **4.8.63 Help Menu**

The Help menu contains helpful information about the Tag Editor. You can search the contents for information about various commands within the tag editor, or you can view information about the Tag Editor application.

#### **4.8.64 Contents**

Lists the contents of the Tag Editor help text.

#### **4.8.65 About TagEdit**

Provides basic version and copyright information about the Tag Editor application.

## 4.8.66 Font Editor

### 4.8.67 Font Editor

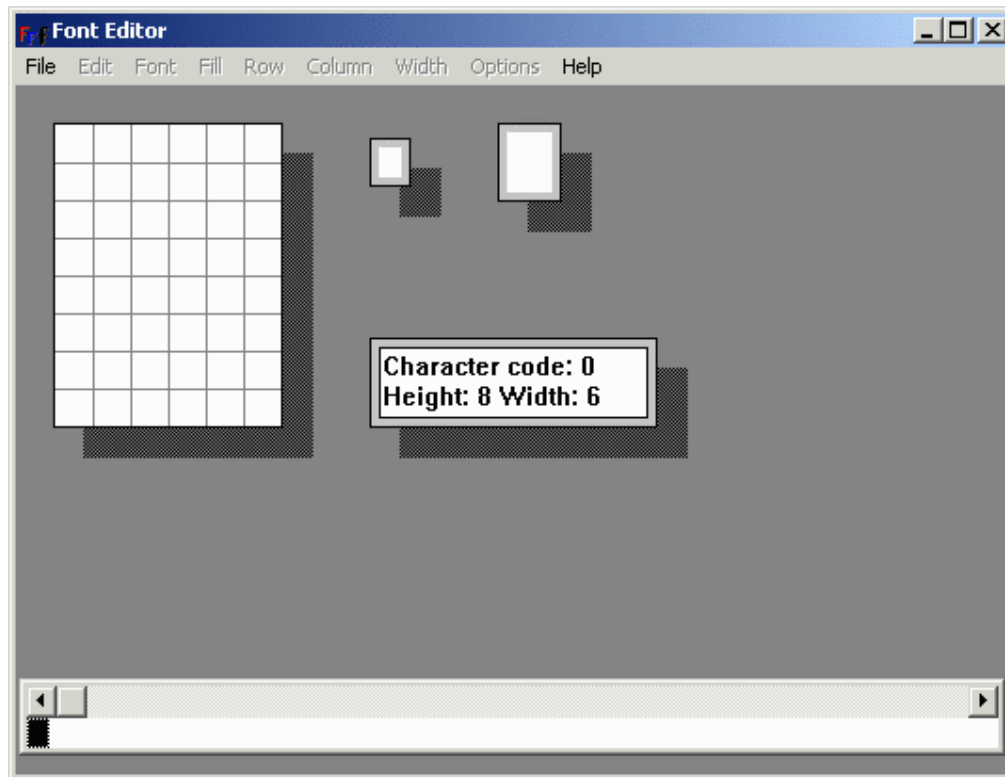

The Font Editor lets you modify the downloadable font of semi-graphical displays. Each font consists of 256 characters that can be edited or changed. This lets you create any necessary characters for a particular project. In most cases, you would not want to edit any of the standard characters such as letters, numbers, large character blocks, or bargraph blocks.

The Font Editor has its own menus and toolbar. The characters of the currently selected font are displayed across the bottom of the Font Editor screen. Click on a character to display it in the Font Editor window.

The Font Editor includes the File menu, the Edit menu, the Font menu, the Fill menu, the Row menu, the Column menu, the Width menu, the Options menu, and the Help menu.

## 4.8.68 File Menu

### 4.8.69 File Menu

The Font Editor File menu contains familiar Windows<sup>™</sup>-type commands such as Open, Save, Save As and Exit.

In addition, the command Install/View installed Panel Fonts lets you view Panel Display Types and corresponding Installed Fonts with the font width and height.

The Install Font button lets you select the display panels with which this font is to be used. The font will then be listed in the Installed Fonts box. The Remove Font button lets you delete the currently highlighted font from the Installed Fonts list.

An example of saving and installing a new font is available.

#### 4.8.70 Open

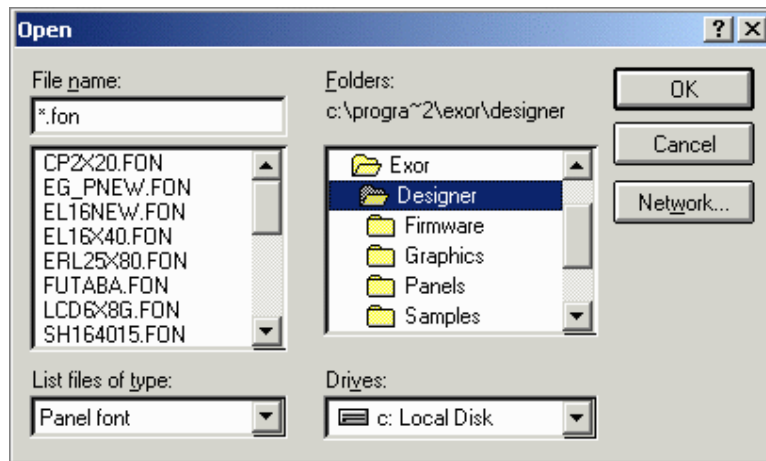

This familiar Windows™ box allows you to choose a file to open in the Font Editor. Font files are normally in the format \*.fon.

#### 4.8.71 Save

To save a project, select Save from the File menu.

The cursor may be momentarily replaced with an hourglass while the file is saved.

If the application has not been named, the Save As dialog box will appear instead.



#### 4.8.72 Save As

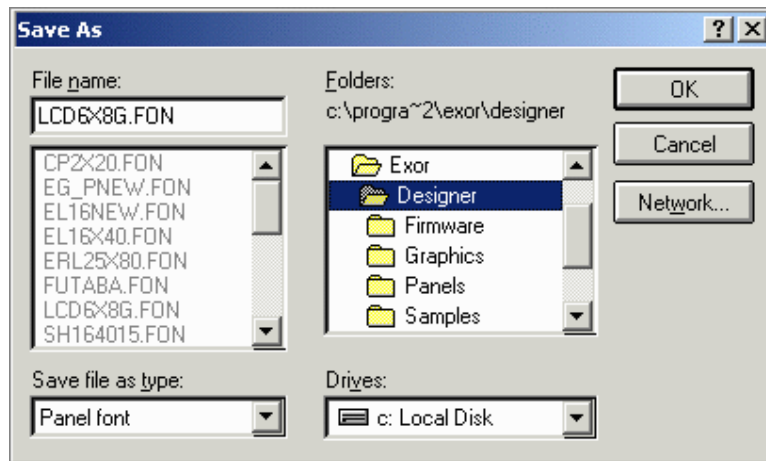

This familiar Windows™ box lets you save a file in the Font Editor. Enter a file name and specify where the file is to be saved.

#### 4.8.73 Edit Menu

The Font Editor Edit menu contains familiar Windows™-type commands such as Undo, Copy, Paste and Refresh.

#### 4.8.74 Font Menu

#### 4.8.75 Font Menu

The Font Editor Font menu lets you see the font size and see, modify, the font header information.

#### 4.8.76 Font Size

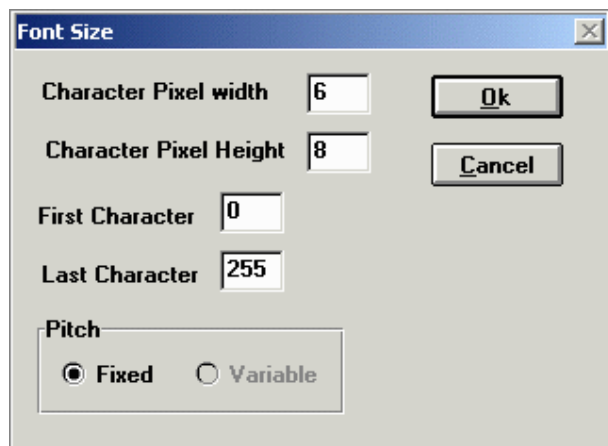

The Font Size dialog box in the Font Editor lets you see the character pixel width and height, the first and last character, and the pitch for a font.

#### 4.8.77 Font Header

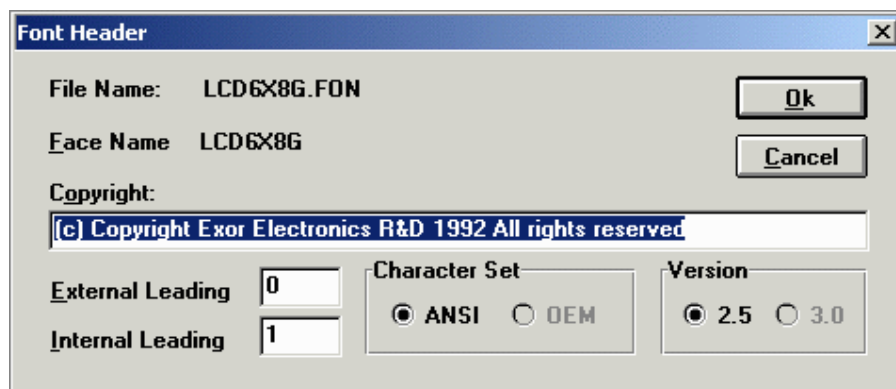

The Font Header dialog box lists the file name used for the selected font, the face name (font name) for that font, provides a box for entering any necessary copyright information, sets the external and internal leading values, identifies the character set and the version.

#### 4.8.78 Fill Menu

It is possible to fill the entire character grid with either white or black, or to invert the displayed colors.

By double clicking on a particular pixel, you can toggle the appearance of that pixel. For example, if a pixel is initially black, double clicking on it will change its color to white.

An example of editing characters is provided.

#### **4.8.79 Row Menu**

The Insert and Delete commands on the Row menu of the Font Editor let you customize a character by adding or deleting a row of pixels.

Note: The row is added or deleted from the present position of the cursor.

Note: When a row is added all the other rows below it are shifted one pixel down.

#### **4.8.80 Column Menu**

The Insert and Delete commands on the Column menu of the Font Editor let you customize a character by adding or deleting a column of pixels.

Note: The column is added or deleted from the present position of the cursor.

Note: When a column is added all the other columns to its right are shifted one pixel to the right.

#### **4.8.81 Width Menu**

The Font Editor Width menu is currently disabled.

#### **4.8.82 Options Menu**

#### **4.8.83 Options Menu**

The Font Editor provides a method of editing characters that are used in basic character formation. These commands are available under the Options menu of the Font Editor. Commands in the Options menu include:

Rectangles,

Large Characters,

Bargraphs,

Define Symbol, and

Symbol Browser.

#### **4.8.84 Rectangles**

By selecting Rectangles from the Options menu of the Font Editor, you can edit the characters that form each of the two rectangles that are implemented in the Designer software.

The rectangle is composed of eight characters: 4 corner characters and 4 characters that connect the corners. By selecting any of these characters, you can create the rectangle with a particular style. Designer comes with two default rectangle styles: single line and double line.

Once you have defined the characters that make up the rectangle, you can draw a rectangle of any size in any page of your project.

Note: You should launch the Font Editor from within Designer, so that the necessary .INI files are updated automatically. If the Font Editor is launched outside of Designer, you will need to enter the character codes that make up the rectangle into the DISPLAYS.INI file manually. This file is located in the Windows directory. As you scroll through the file, each font will have a line that begins with BoxChars=. You will need to specify the eight character codes that make up the rectangle. These codes need to be entered in scanline order - left to right, top to bottom of the rectangle. So, you would first start with the top, left corner of the rectangle extending across the top. You would then go to the top, left corner and extend down. Next, go to the top, right corner and extend down. Finally, you would go to the bottom of the rectangle.

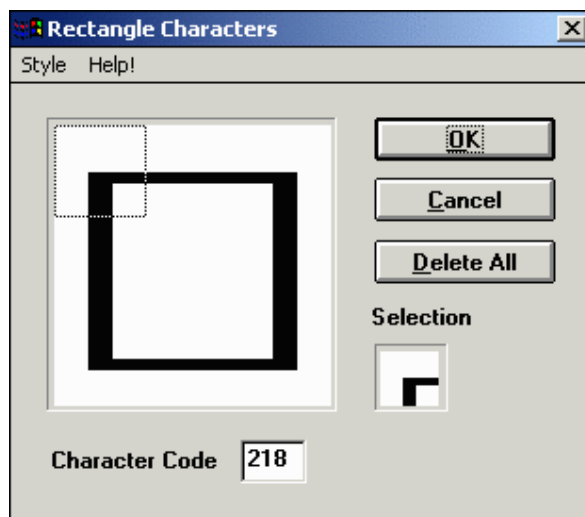

The above dialog box is used to define each of the eight characters that make up a rectangle. To get an explanation about the function of any part of the dialog box, position the mouse over the area and click the left mouse button.

#### 4.8.85 Large Characters

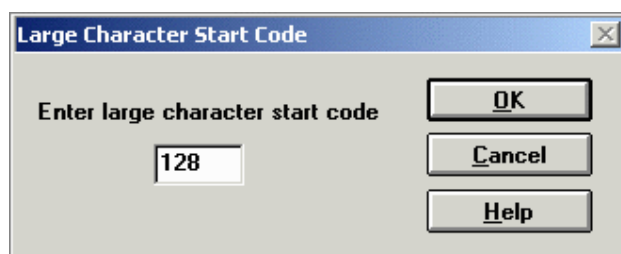

The large character set must be kept continuous. The Large Character Start Code dialog box in the Font Editor identifies the starting character in a large character set.

Note: This starting character is not the same for every font.

Note: The characters in the sequence must have a predetermined shape. Characters that are larger than the standard panel character set are composed algorithmically from the set of specially shaped characters shown below. You must maintain this exact sequence of shapes in order to introduce large characters into your font.

#### 4.8.86 Bargraphs

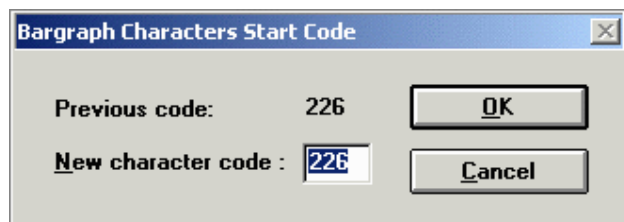

The Font Editor start code for bargraphs is the first non-blank character within the bargraph character set. Keep in mind that the bargraph character set must be kept continuous (i.e., the characters must be kept in numerical order).

Note: The character code will not be the same for each font.

#### 4.8.87 Define Symbol

The Designer software offers you the ability to create your own symbols using the Font Editor. While still included in the software, this feature has become obsolete with the current graphical release.

To select symbol mode, select Define Symbol from the Options menu.

Select Symbol Dimensions and enter the height and width of the symbol you would like to define.

Select OK.

Select Define Symbol - Draw New Symbol from the Options menu.

The display will then change to the symbol dimensions that were selected. The editor will put the selected number of characters from the font in this symbol edit box, starting with the character that was highlighted.

Select Define Symbol - Compose Symbol from the Options menu. Double-click on each character that makes up the symbol. Start with the character is in the upper left-hand corner and move across. The light gray character box will automatically move to the next character location. If you make a mistake, simply single click on the character location to move the cursor box and then double-click on the correct character in the font bar. When the symbol

contains all the correct characters, click in the small upper box. Give the symbol a name by typing it in this box and clicking on OK.

#### **4.8.88 Symbol Browser**

The Symbol Browser allows browsing among the symbols you have created in the Font Editor.

To create a new symbol use Options - Define Symbols - Symbol Dimensions.

Select the size of the new symbol (in number of characters).

When you select the enabled item Draw new Symbol the Font Editor represents a preview of the new symbol in a map of 2 by 2 characters.

The preview consists of the current character plus the next 3 characters. Since in our example we selected a symbol size of 2 by 2 characters we need in fact 4 characters in total.

When the new symbol is modified using the bitmap editor, the Font Editor automatically changes all the involved characters.

#### **4.8.89 Help Menu**

The Help menu is constructed in the typical Windows™ manner, with a list of the Contents of the help text, and information about the Font Editor.

#### **4.8.90 Font Editor Example**

#### **4.8.91 Font Editor Example**

Creating or modifying a font using the Font Editor consists of two parts; editing the character(s), and then saving the new or modified font.

#### **4.8.92 Editing Characters**

Select Font Editor from the Tools menu.

The font will appear on the display in the Font Editor as shown in the figure below.

(insert figure here)

Select a character to edit by clicking on it from the character list across the bottom of the window.

By double clicking on a particular pixel, you can toggle the appearance of that pixel. For example, if a pixel is initially black, double clicking on it will change its color to white.

To save the changes you have made, see the Saving a Font section.

#### **4.8.93 Saving a Font**

When finished modifying the font (see the Editing Characters section) you can save it by selecting Save or Save As from within the File menu within the Font Editor. When changing a font, we recommend that you use Save As and give the font a new name so as not to change the original font. Fonts need to be saved to the Windows System directory.

The font must then be installed by selecting Install/View installed Fonts under the File menu within the Font Editor. Select the display panels with which this font is to be used and click on the Install Font button.

Select File - Exit from the Font Editor to return to your Designer project page.

Now choose Edit - Fonts - Panel Font from within Designer (or press Ctrl+F or click on the Panel Font icon in the toolbar) and the customized font will be available from the Font Name pulldown menu in the Select Font dialog box.

## 4.8.94 Keypad Designer

### 4.8.95 Keypad Designer

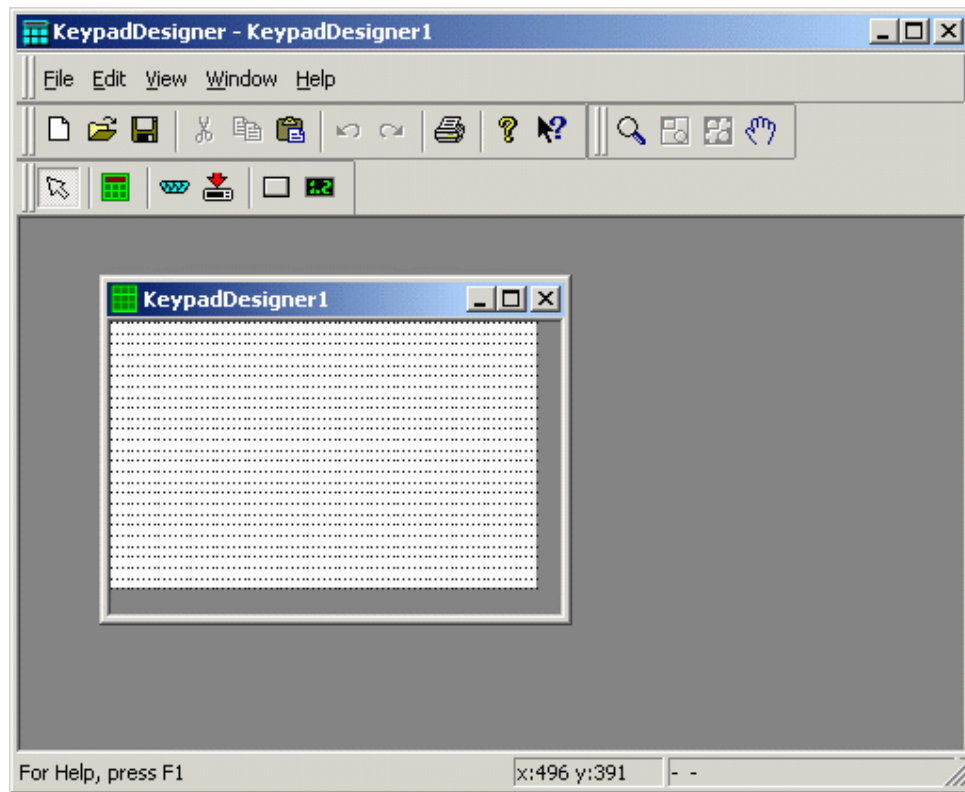

The Keypad Designer utility is a Windows<sup>™</sup>-based application that allows you to design, manage and download custom keypads to a UniOP panel. It is possible to define customized floating popup keypads for four different types of fields by using the Keypad Designer utility. These fields are:

numeric fields with a decimal base,

numeric fields with a hexadecimal base,

ASCII fields, and

message fields.

These popup keypads are dynamic objects that are displayed by the UniOP firmware over the current page whenever Data Entry is started on a field for which a popup keypad is defined.

Note: Touch Data Entry Keypads are only supported by firmware type 58 starting from version 4.40.

A Keypad Designer keypad can contain two types of objects:

Buttons



## Value Objects

Buttons can represent any of the keys that are present on a standard keyboard (i.e., F1, Enter). A Keypad Designer button is merely a button programmed to execute a certain action

Value objects are rectangular areas inside the keypad where the UniOP firmware displays different information related to the field that is being edited. A value object is a field that is able to display a value.

To create a new popup keypad, select New from the Keypad Designer File menu. The Keypad Designer utility presents a blank programming area where the keypad can be designed.

File Menu

Edit Menu

View Menu

Window Menu

Help Menu

Buttons

Value Objects

### **4.8.96 File Menu**

### **4.8.97 File Menu**

The File menu contains familiar Windows™ commands for managing files and printing.

New

Open

Close

Save

Save As

Print

Print Preview

Print Setup

Recent Files

Exit

plus the less familiar commands

Export to ROM, and

Download to ROM

## 4.8.98 New

A new Keypad Designer File may be created by selecting New from the File menu, by clicking the New Keypad icon, or by pressing the Ctrl+N keys.

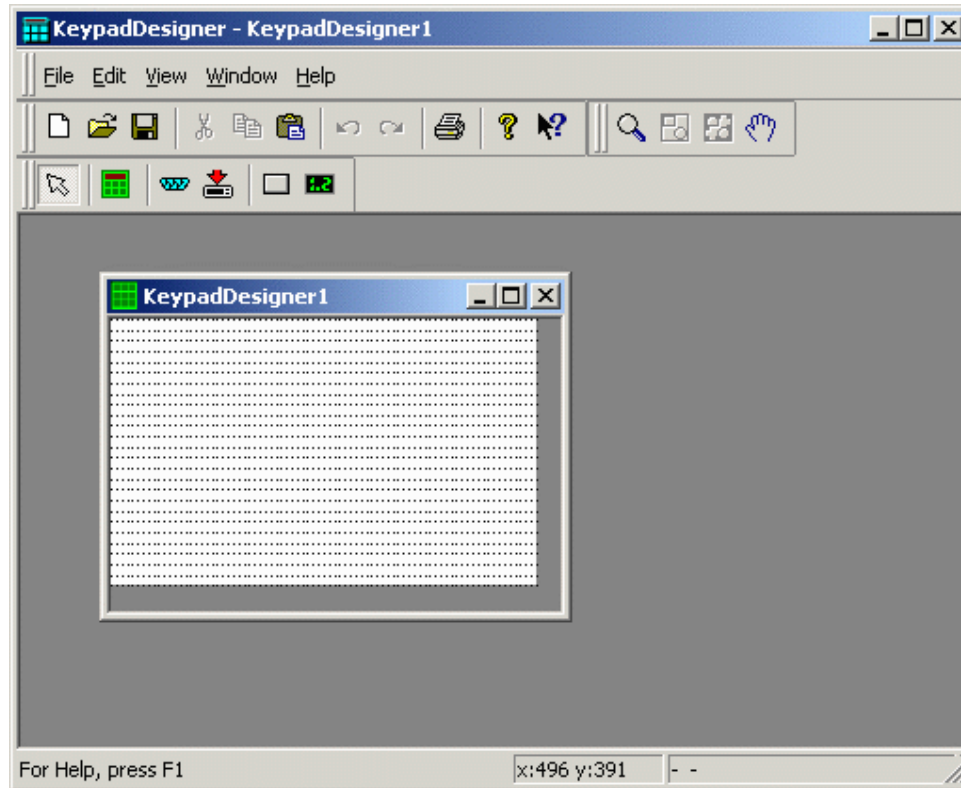

The file is created with a default name. You can change this name when saving the file, by selecting the Save As from the File menu.

## 4.8.99 Open

To open an existing Keypad Designer File, select Open from the File menu, click the Open icon on the toolbar, or press the Ctrl+O keys. The Open Keypad dialog box will appear, providing a list of the file names in each directory.

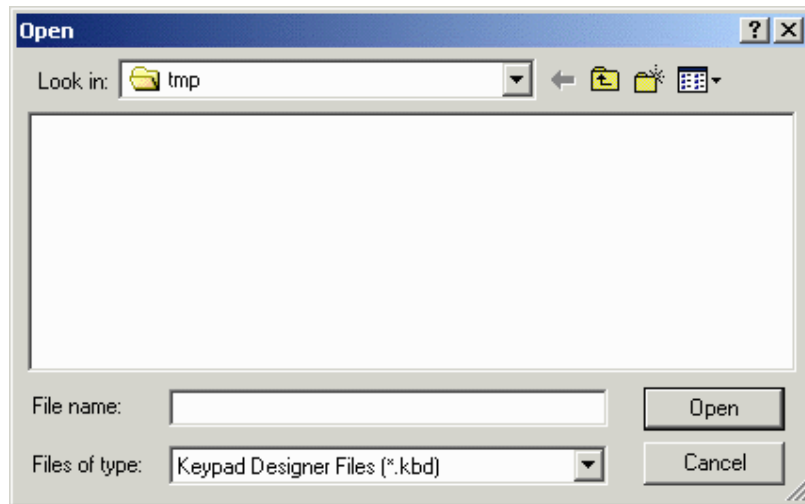

Enter the name of the file to be loaded or use the list box to select from the existing files. If an extension is not specified, .kbd is assumed.

#### **4.8.100 Close**

To close a currently open file, select Close from the File menu.

#### **4.8.101 Save**

To save a Keypad Designer Files, select Save from the File menu, click on the Save file icon on the toolbar, or press the Ctrl+S keys.

#### **4.8.102 Save As**

If a Keypad Designer file to be saved has not been named, the Save As dialog box appears. Or, you may select Save As from the File menu. This option can also be used to save a Keypad Designer File under a different name.

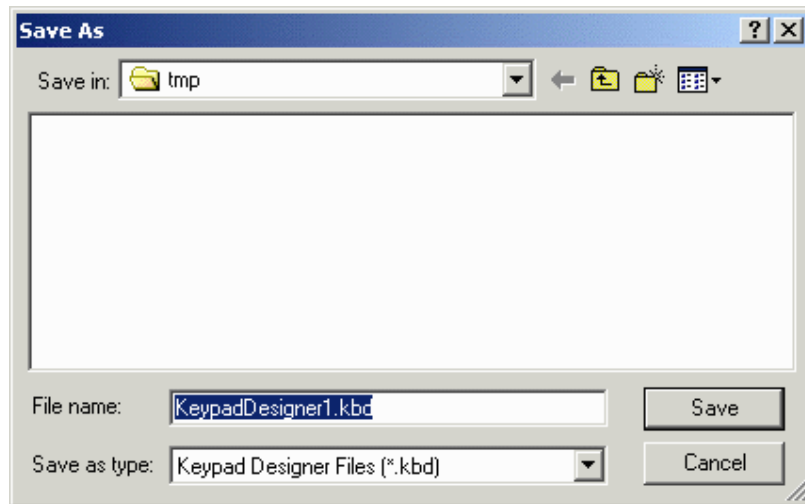

The Save As dialog box shows the current directory path and the current file name. A new name and path may be entered or the ones presented may be accepted.

#### **4.8.103 Print**

Selecting Print from the File menu (or pressing the Ctrl+P keys) brings up the familiar Windows™ Print dialog box, from which the currently open may be printed.

#### **4.8.104 Print Preview**

Selecting Print Preview from the File menu brings up the familiar Windows™ Print Preview view, from which the currently open Keypad may be previewed for printing.

#### **4.8.105 Recent Files**

The most recently opened files are listed under the File menu as a shortcut. Click on the name of a file to reopen it.

#### **4.8.106 Exit**

Selecting Exit from the File menu can be used to terminate the Designer program. You are prompted to confirm the operation if the current application has not been saved.

## 4.8.107 Export to ROM File

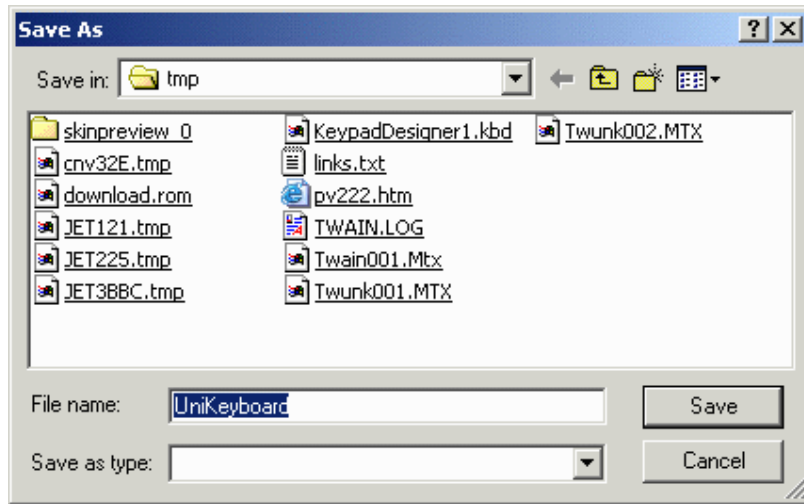

This creates a binary file with extension .ROM that can be used to program the memory card directly using a programmer.

## 4.8.108 Download to Panel

Floating keypads created with the Keypad Designer software need to be downloaded to the panel in addition to the standard project file. Once the keypads have been downloaded, the UniOP panel will use them for editing when in Data Entry mode.

Note: If you created a custom Data Entry screen using the Special Pages section in Designer, the keypads created in the Keypad Designer software will not be used.

Keypad Designer keypads can be downloaded to the UniOP panel by using the standard download cable connected to the PC/Printer port.

Selecting the Download icon will start the communication session between the Keypad Designer utility and the UniOP panel.

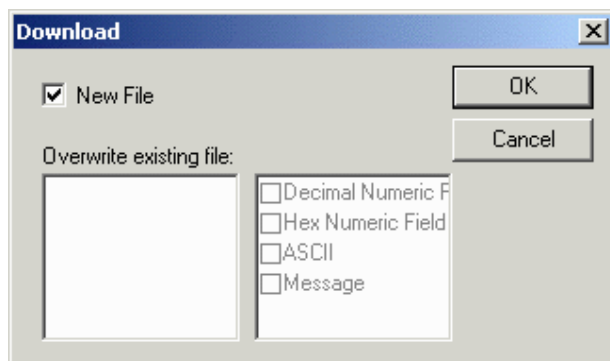

When the New File checkbox is marked, this indicates that the keypad being downloaded is a new object that is not intended to substitute an existing keypad.

The left part of the dialog box shows the keypads that have been downloaded to the UniOP panel. The right part of the dialog box shows the association between each of the keypads and the corresponding field types.

When selecting OK, the download procedure will begin and the Transfer dialog box will be displayed.

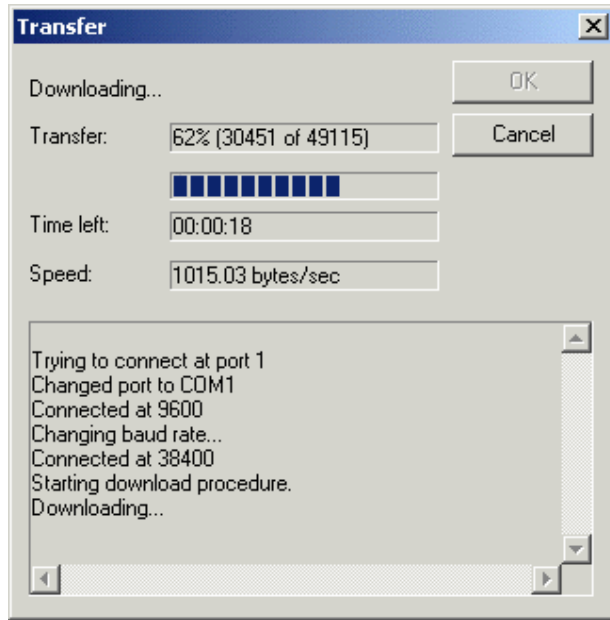

This dialog box shows information about the current download process, such as the completion rate of the process, the estimated time for completion and the average transfer speed.

Once the file download is completed, the next keypad can be downloaded to the UniOP panel.

#### 4.8.109 Edit Menu

#### 4.8.110 Edit Menu

The Edit menu contains many familiar Windows™ commands for working with text and objects on the page.

Undo

Redo

Cut

Copy

Paste, and

Delete,

plus the less familiar commands

Components

Communication Parameters

Keyboard

SSFDC

#### 4.8.111 Components

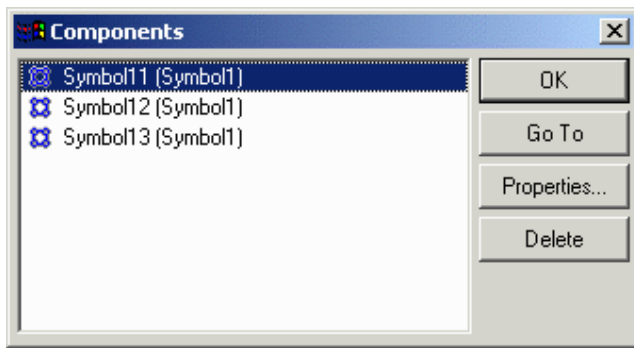

The Components dialog shows in one single list all the object / components present in a given page.

#### 4.8.112 Communication Parameters

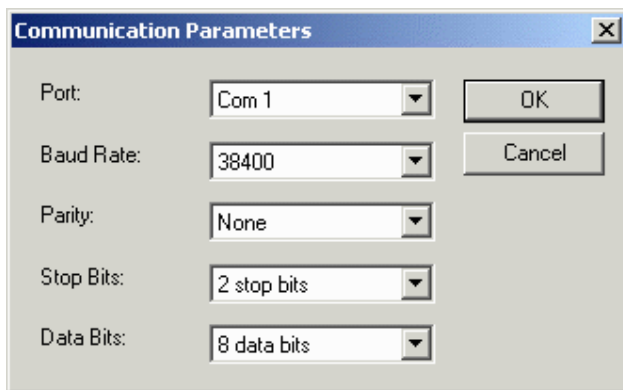

The Communication Parameters dialog allows the user to configure the setting of the communication port.

The communication parameters need to be set as follows in order to perform a successful keypad download:

Baud rate: 38400 (recommended)

Parity: none

Stop bits: 2

Data Bits: 8

In addition, specify the Com Port to be used.

#### 4.8.113 Keyboard

#### 4.8.114 Keyboard

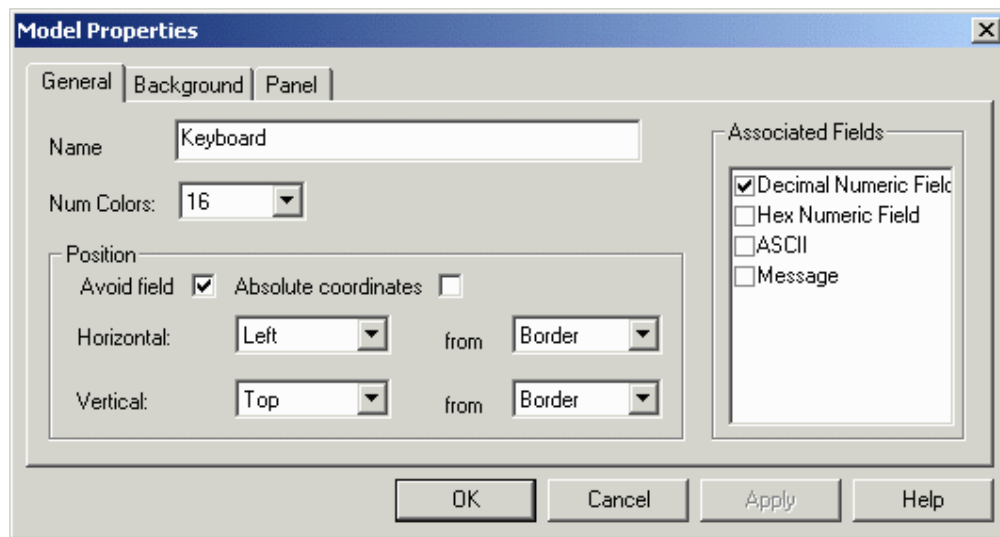

When you select Keyboard from the Keypad Designer Edit menu (or clicking the Keyboard Properties icon) the Model Properties dialog box is displayed, allowing you to define the basic parameters of the keypad. The Model Properties dialog box consists of three tabs:

General

Background

Panel

#### 4.8.115 General

##### General tab



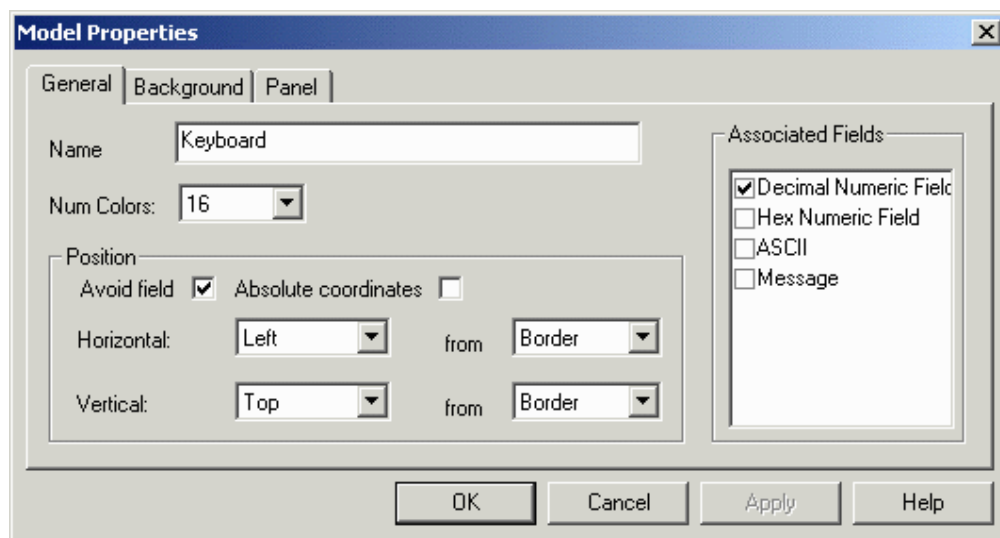

Items on the General tab allow you to specify a name, the number of colors, the type of associated fields, and position information.

**Name**

The name assigned to the keypad. This is used by Keypad Designer to identify different keypads.

**Number of Colors**

Lets you select the number of colors used to represent the keypad.

**Associated Fields**

Specifies the types of fields that can be edited using the selected keypad.

Note: A field type (i.e., numeric field with decimal base) can have only a single keypad associated with it.

Position

**Position**

The Position area contains the controls used to define where the keypad will appear on the display, including:

Avoid Field

Absolute Coordinates

Horizontal Position

Vertical Position

**Avoid Field**

When checked, this specifies that the keypad will be displayed in a position such that the field being edited will not be covered by the keypad. When Avoid field is checked, the Horizontal and Vertical controls allow you to define the position of the keypad.

**Absolute Coordinates**

When this checkbox is marked and the Panel Predefined Model has been selected, the keypad will be placed by the UniOP firmware in the same position as it is displayed in the Keypad Designer utility. If the Avoid field checkbox is also selected, the firmware will place

the keypad in the specified position only if the field under editing is not covered by the keypad.

**Horizontal Position**

The Horizontal position can be Left, Center, or Right. This refers to relative position, the references of which can be specified in the corresponding from list box.

**Vertical Position**

The Vertical position can be Top, Center or Bottom. This refers to relative position, the references of which can be specified in the corresponding from list box.

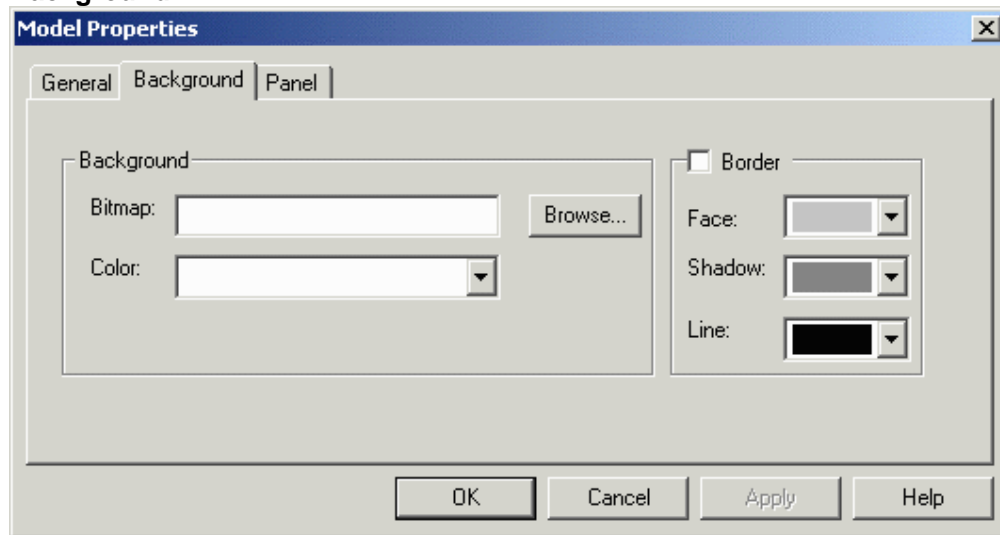
**4.8.116 Background****Background**

Allows you to specify both Background and Border properties.

**Background**

You can select a bitmap image to be used as the background of the keypad. The Browse button allows you to search for an image and select it to be entered in the Bitmap box.

The Color list box allows for selection of the desired background color.

**Border**

Check the box to include a border. Allows you to specify the color of the border of the keypad.

**4.8.117 Panel****Panel**

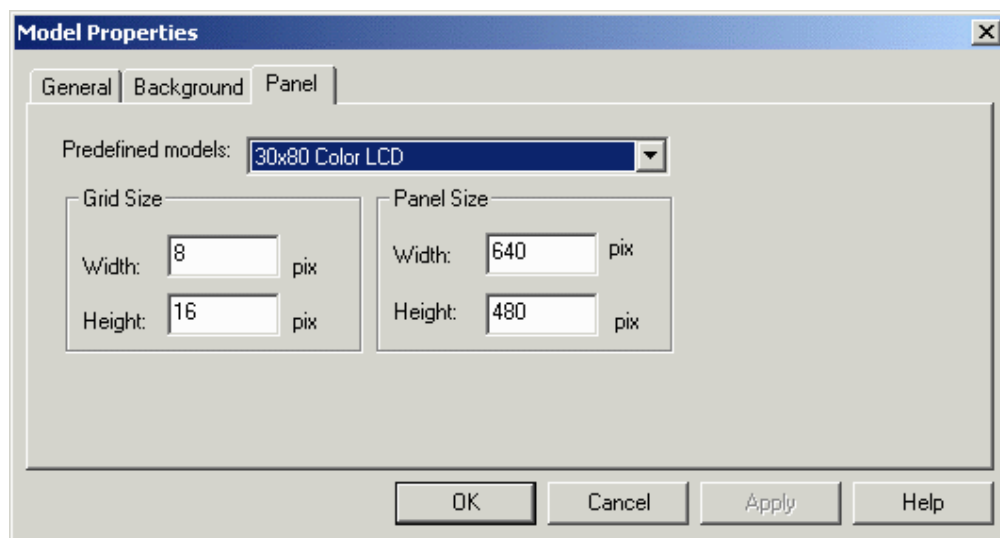

Options on the Panel tab allow you to set the type of panel model or the panel size, and the grid size.

### Predefined Models

Lets you specify the display type of the panel to which the keypad will be downloaded. This is especially useful when absolute coordinates are used to place the overlapping keypad.

### Panel Size

This can be used to set the dimensions of the UniOP panel when the Predefined models option is not defined. Specify the panel width and height in pixels.

### Grid Size

Specifies the character grid size (in pixels) of the panel where the keypad will be downloaded. Correct values for the grid size can be derived from Designer by selecting one character and reading the pixel size of the selected area in the Designer Status Bar.

## 4.8.118 SSFDC

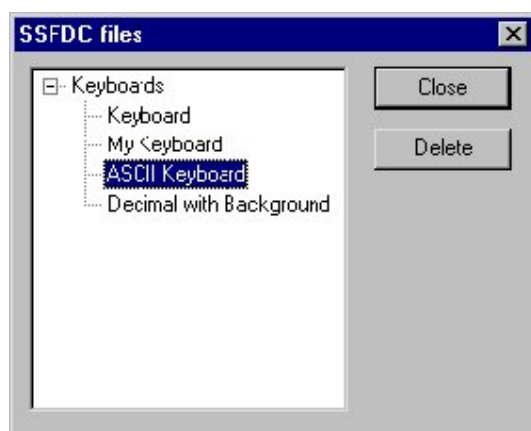

When the UniOP panel is in Configuration Mode, selecting SSFDC from the Edit menu within the Keypad Designer software will return a list of all the keyboard files currently stored in the UniOP memory.

To delete a particular keypad, simply select the name of the keypad from the list and click on the Delete button.

To close the communication session, click on the Close button.

#### **4.8.119 View Menu**

This section provides information about the View menu. The View menu lets you set the screen to view the project in the most comfortable manner for various tasks.

The items Toolbar, Status Bar, and Grid may be checked in the View menu to make them visible. Uncheck them if you do not want them visible in the current workspace.

Zoom commands on the View menu include:

Zoom Normal - to return to normal viewing

Zoom Percent - to zoom in by a preset percentage of 50%, 75%, 100%, or 200%.

Zoom Custom - to magnify by a percentage that you specify

Zoom to Fit - to zoom to fit the defined viewing space.

#### **4.8.120 Window Menu**

The Window menu contains familiar Window<sup>™</sup> commands for managing multiple windows. These include:

New Window - opens a new window

Cascade - places each new window slightly below and to the right of the current window.

Tile - places each new window below the current window.

Arrange Icons - arranges the visible icons in an orderly manner

Currently Open File(s) - the filenames of the currently opened files.

#### **4.8.121 Help Menu**

The Help menu is constructed in the typical Windows<sup>™</sup> manner, with a list of the Contents of the help text, and information about the Keypad Designer.

## 4.8.122 Buttons

### 4.8.123 Creating Buttons

To create a Button, click the Button icon and click on the screen.

A button appears with its upper left corner at the point where you clicked. Right click on the button and select Properties to bring up the Uni Button dialog box,

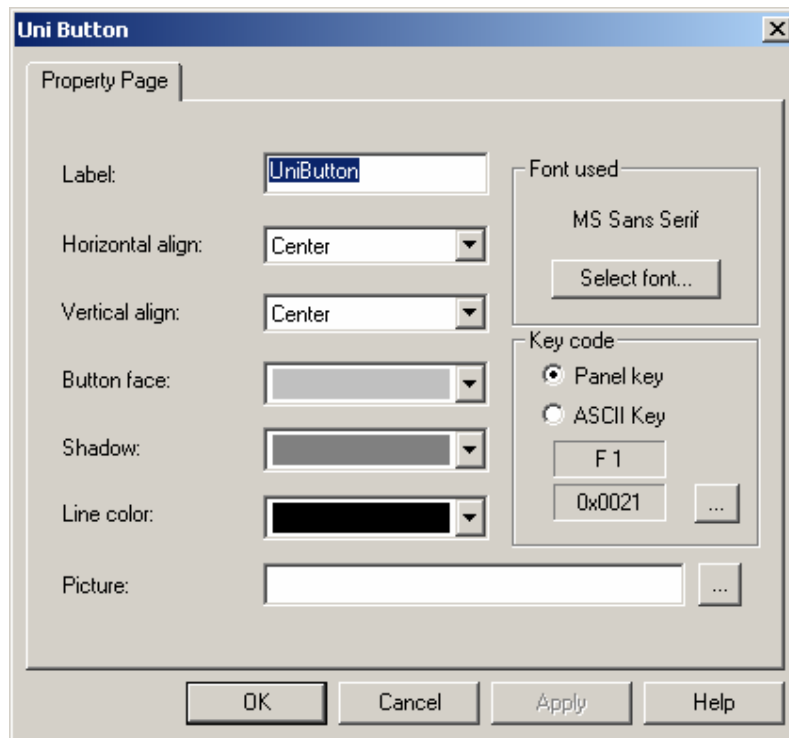

where you can define the functionality of the button, including Colors, Key Code, and Label.

#### Font Used

The "Select font" button allows to define which font has to be used for the button label, including UniOP fixed fonts.

If the UniOP standard Fixed font has been modified to include some special symbols or characters, it can be directly used here for the label. The font selection here is not related to the function of the button, configured instead in the "Key Code" area.

#### Key code

Specifies the functionality assigned to the button. Each button can be assigned as a standard UniOP key or as an ASCII character. The available selections in the list for ASCII keys comes directly from the font used specified above.

Note: Keypad Designer does not support Unicode coding for characters.

#### **4.8.124 Colors**

The Colors area contains three list boxes that let you select the colors for the button face, the button shadow and the button line.

Using a proper combination of the three colors will result in a three-dimensional aspect of the button.

The button can also be made to appear as a "flat button" by assigning the same color to the Shadow and Line color.

#### **4.8.125 Key Code**

The functionality assigned to the button. Each button can be assigned as a standard UniOP key or as an ASCII character.

The available selections in the list can be fully personalized by modifying a configuration file in the Keypad Designer installation directory called KeyCodes.txt. This file contains the ASCII codes and the UniOP key definition used by the Keypad Designer software to build the Key Code list of available functions and can be modified by any text editor.

#### **4.8.126 Label**

#### **4.8.127 Label**

The Label area contains the necessary selections required to customize the button label.

#### **4.8.128 Text**

The text that will appear on the face of the button.

#### **4.8.129 Font**

The font in which the label is displayed. This can be any Windows<sup>TM</sup> font that is installed on the computer that is running the Keypad Designer utility.

#### **4.8.130 Picture**

This lets you specify a background bitmap image for the button. Use the Browse button to select a bitmap image.

## 4.8.131 Horizontal Align

Specifies the horizontal position of the label (right, center, left).

## 4.8.132 Vertical Align

Specifies the vertical position of the label (top, center, bottom).

## 4.8.133 Value Objects

### 4.8.134 Creating Value Objects

Creating Value Objects is done in much the same manner as creating a Button. Simply click the Value icon and click on the screen. An object appears with its upper left corner at the point where you clicked.

Right click on the object and select Properties to bring up the Value Box dialog box.

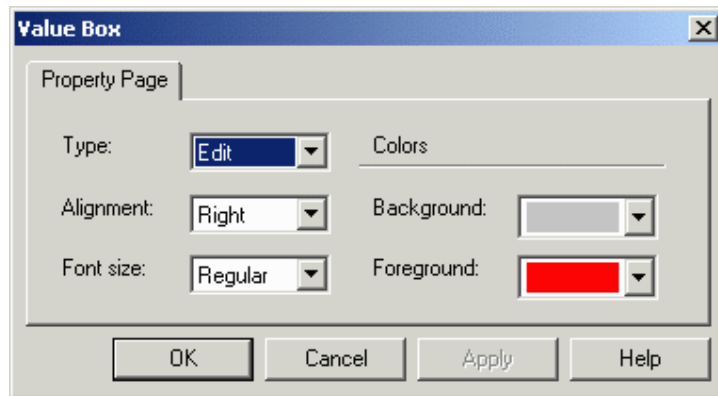

From the Value Box dialog box you can set the following

Type

Alignment

Font Size

Colors.

### 4.8.135 Type

The type of value object being created

Edit (current) value

The field is configured for the editing process.

Old value

The field is configured to display the old value of the controller variable being edited.

Min (minimum) value

The field is configured to display the minimum allowable value that has been programmed for the controller variable being edited.

Max (maximum) value.

The field is configured to display the maximum allowable value that has been programmed for the controller variable being edited.

#### **4.8.136 Alignment**

Specifies the alignment of the different value objects. Possible options are: Left, Center, Right and Default.

#### **4.8.137 Font Size**

Select the font size to be used with the value object.

#### **4.8.138 Colors**

The Background and Foreground controls within the Colors area let you specify the background and foreground colors for the value object.



**4.8.139 Customize**

**4.8.140 Customize**

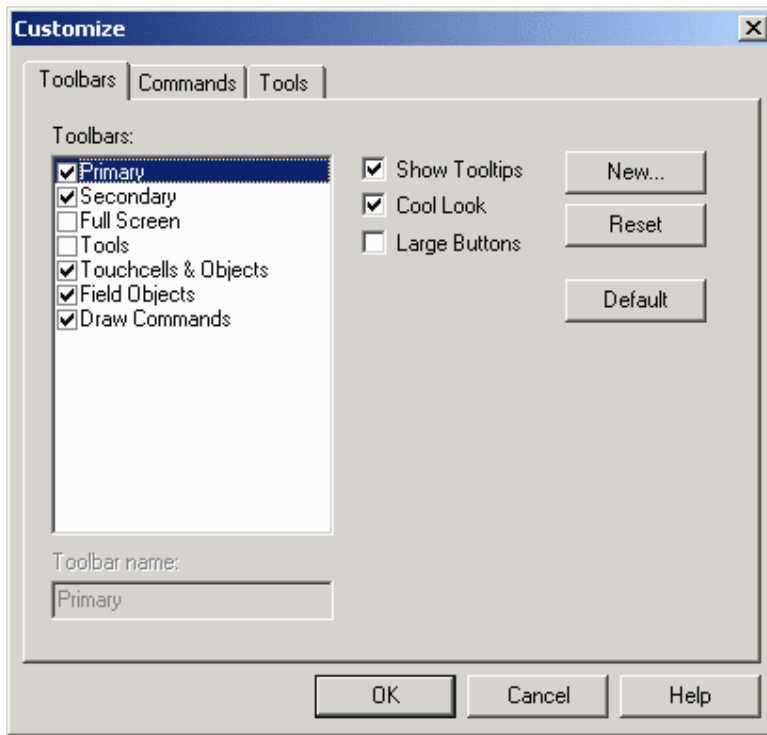

The Customize dialog box (accessible under Tools - Customize or by clicking the Customize button from View - Toolbars) allows you to customize toolbars, commands, and tools within Designer.

**4.8.141 Toolbars**

**4.8.142 Toolbars**

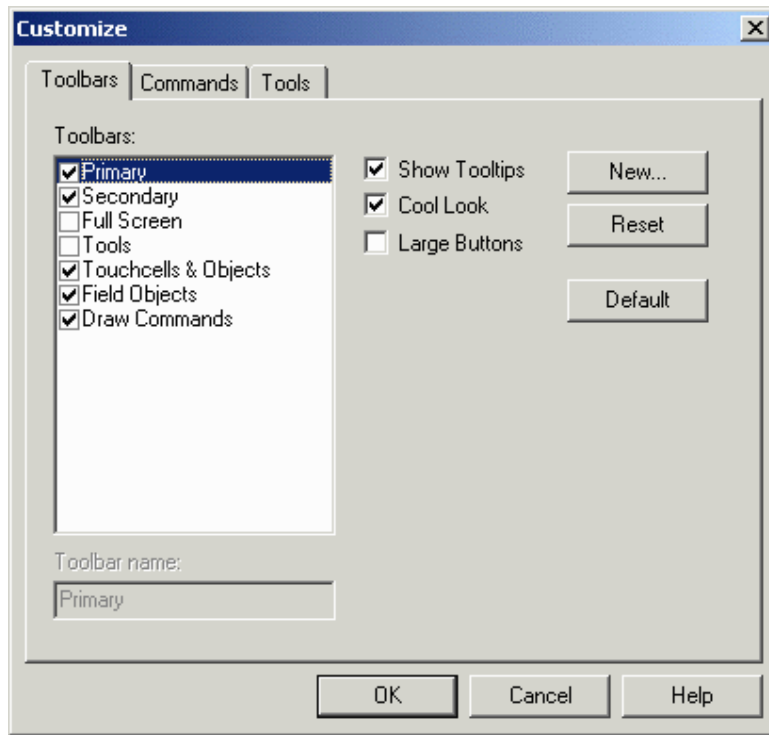

Lists the various toolbars displayed for the current project. These may include the following:

Primary toolbar - typically provides shortcuts to commonly used Windows™-type commands.

Secondary toolbar - typically provides shortcuts to Designer project-level commands

Full Screen toolbar - typically provides shortcuts to viewing preferences

Tools toolbar - typically provides shortcuts to user-specified tools

TouchScreen toolbar - typically provides shortcuts to touchscreen-specific commands

Commands available from the Toolbars dialog box include:

Toolbar Name

Shows the name of the selected toolbar.

Show Tooltips

Provides a short description of a toolbar icon when the cursor pauses above the icon.

#### Cool Look

Gives the buttons on the toolbars an invisible edge, making for a smoother appearance on the toolbars.

#### Large Buttons

Makes the buttons appear twice as large as normal for easier viewing and use.

#### New

#### Reset/Delete

The Reset button returns the toolbars to their default state.

If you have added any toolbars, the Reset button becomes a Delete button so that user-added toolbars can be removed.

#### Default

Click the Default button to align and dock the toolbars to the installed state. It also reloads all buttons on the toolbar.

#### **4.8.143      Toolbar Name**

Shows the name of the selected toolbar.

#### **4.8.144      Show Tooltips**

Provides a short description of a toolbar icon when the cursor pauses above the icon.

#### **4.8.145      Cool Look**

Gives the buttons on the toolbars an invisible edge, making for a smoother appearance on the toolbars.

#### **4.8.146      Large Buttons**

Makes the buttons appear twice as large as normal for easier viewing and use.

#### **4.8.147      New**

The New button brings up the New Toolbar dialog box, where you may enter the name of a new toolbar to be created.

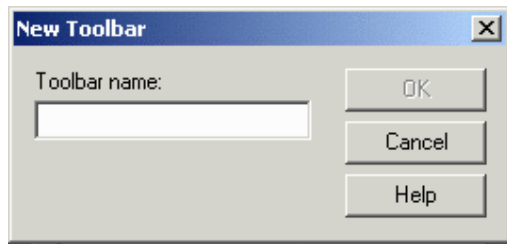

The new toolbar may then be placed in a location of your choice in the toolbar section of the Designer screen.

#### 4.8.148 **Reset Delete**

The Reset button returns the toolbars to their default state.

If you have added any toolbars, the Reset button becomes a Delete button so that user-added toolbars can be removed.

#### 4.8.149 **Default**

Click the Default button to align and dock the toolbars to the installed state. It also reloads all buttons on the toolbar.

#### 4.8.150 **Commands**

#### 4.8.151 **Commands**

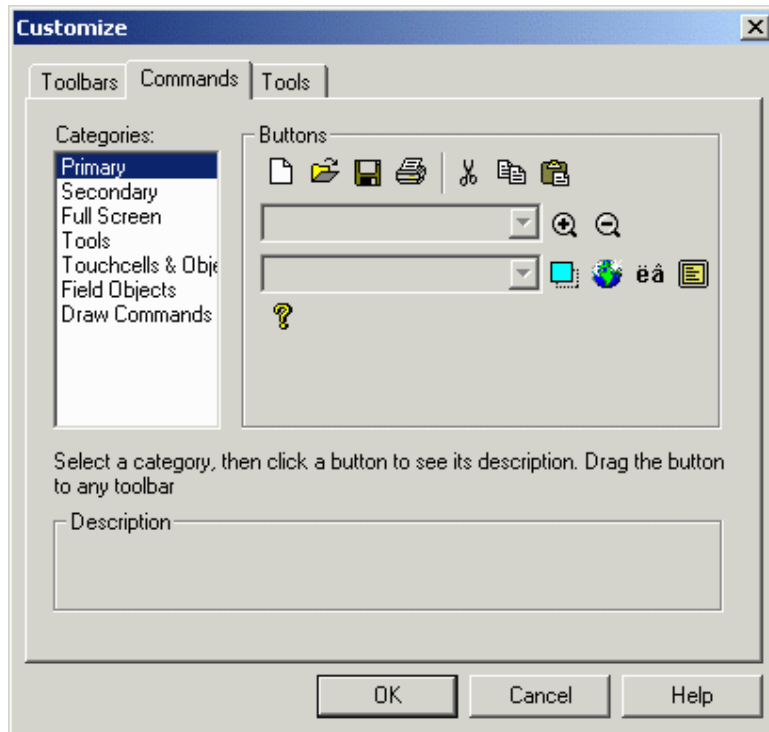

This section lets you customize the buttons and descriptions of various categories of items.

#### 4.8.152 Categories

Lists the various toolbars onto which the various commands are grouped.

#### 4.8.153 Buttons

The icons for the currently highlighted toolbar category are shown. Drag a button to any toolbar.

#### 4.8.154 Description

Displays a description of the activity performed by each button on a toolbar. Select a category, then click a button to see its description.

#### 4.8.155 Tools

#### 4.8.156 Tools

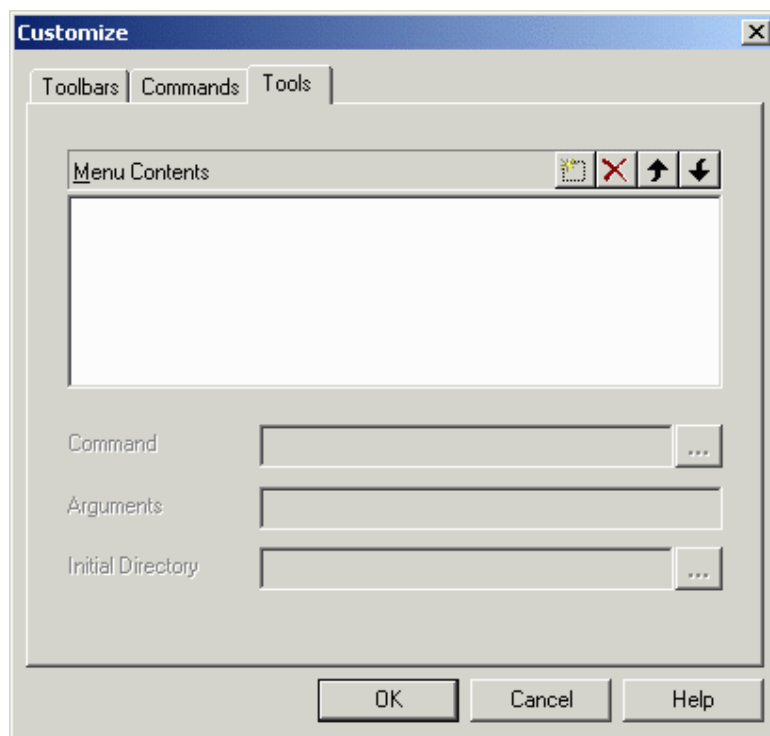

The tools tab allows you to have the possibility to launch external applications from within Designer.

Commands in this tab include:

Menu Contents,

Command,

Arguments, and

Initial Directory.

#### **4.8.157      New**

Inserts a new tool into the list of Menu Contents and the Tools menu.

#### **4.8.158      Delete**

Deletes a tool from the list of Menu Contents and the Tools menu.

#### **4.8.159      Move Up**

Rearranges the list of Menu Contents and the Tools menu so that the selected tool is moved up one position.

#### **4.8.160      Move Down**

Rearranges the list of Menu Contents and the Tools menu so that the selected tool is moved down one position.

**4.8.161 Menu Contents**

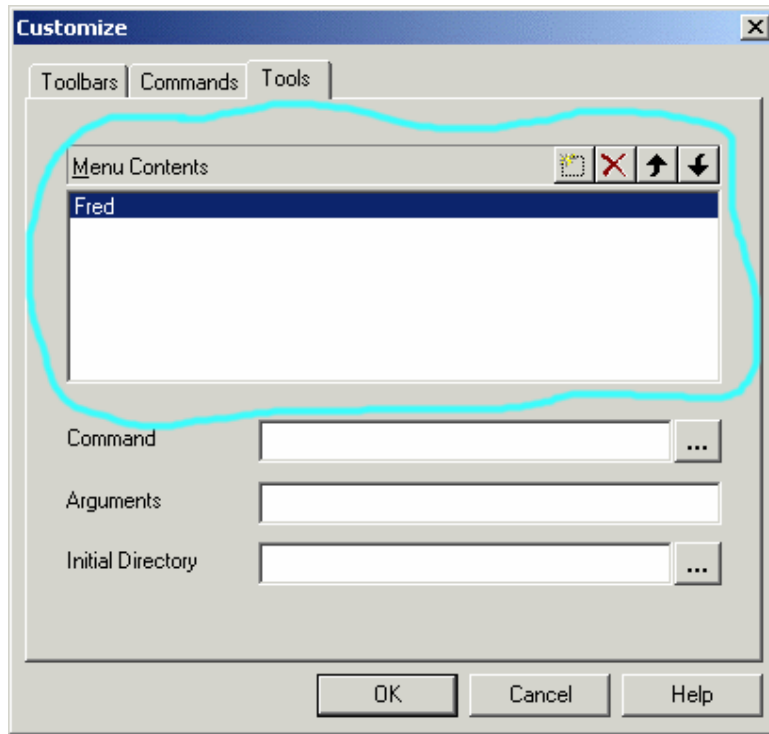

This section of the dialog allows you to define New Tools, to Delete already existing ones, to move one tool up (Move Up) or down (Move Down) in the tools list.

**4.8.162 Command**

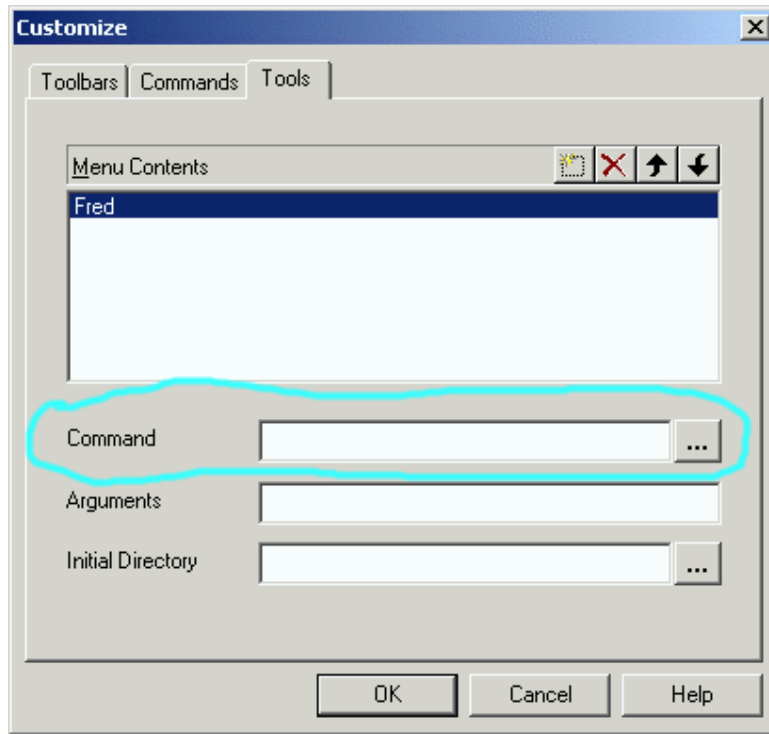

This area of the dialog allows the user to specify the full file name of the application to be launched. Press the "... " button to look in the file system for the application executable file.



**4.8.163 Arguments**

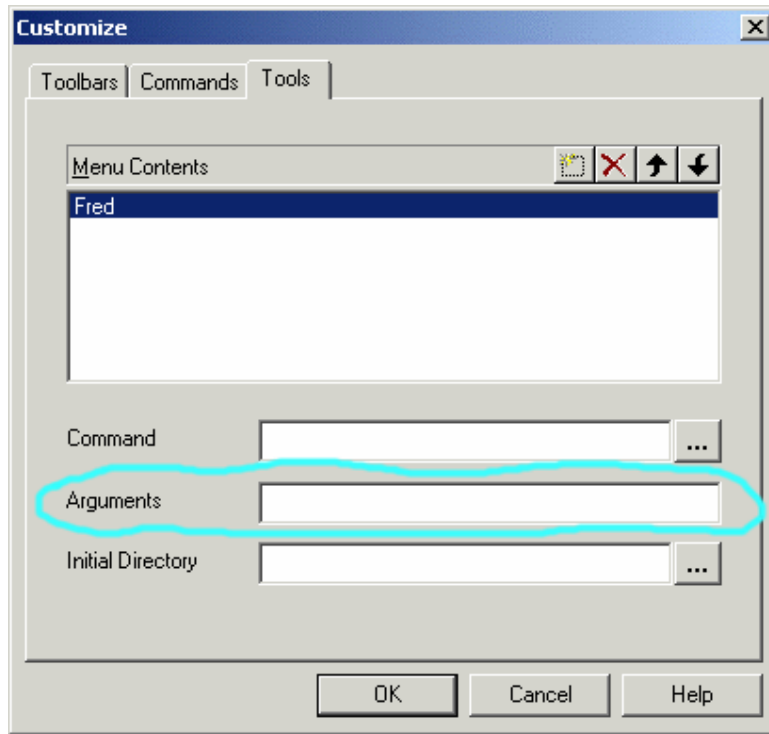

Use this line to enter the optional parameters (command line parameters) that have to be passed to the application.

**4.8.164 Initial Directory**

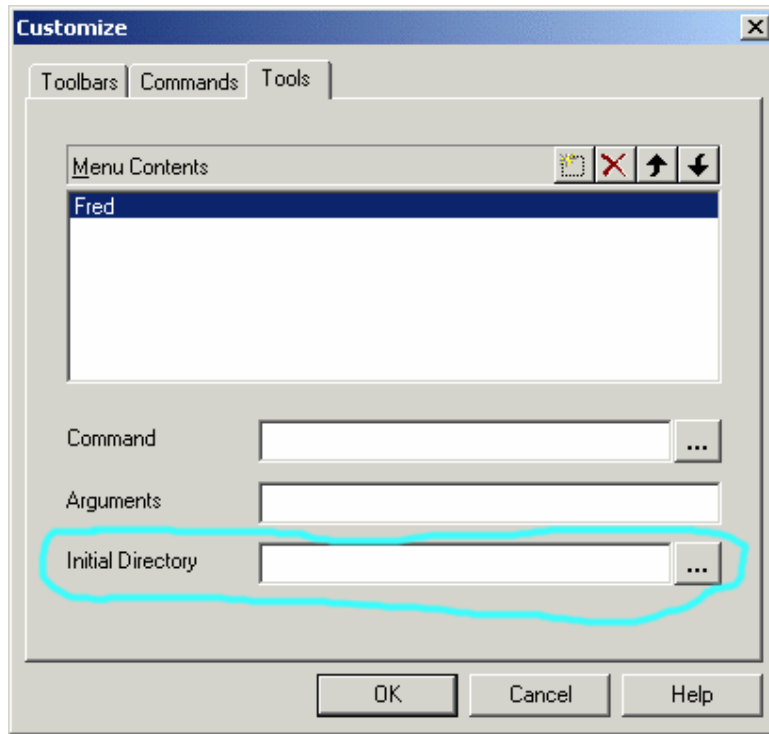

Use this optional field to specify the initial working directory (folder) in which the application is to be launched. Press the "... " button to look in the file system for a suitable directory.

**4.8.165 Options**

**4.8.166 Options**

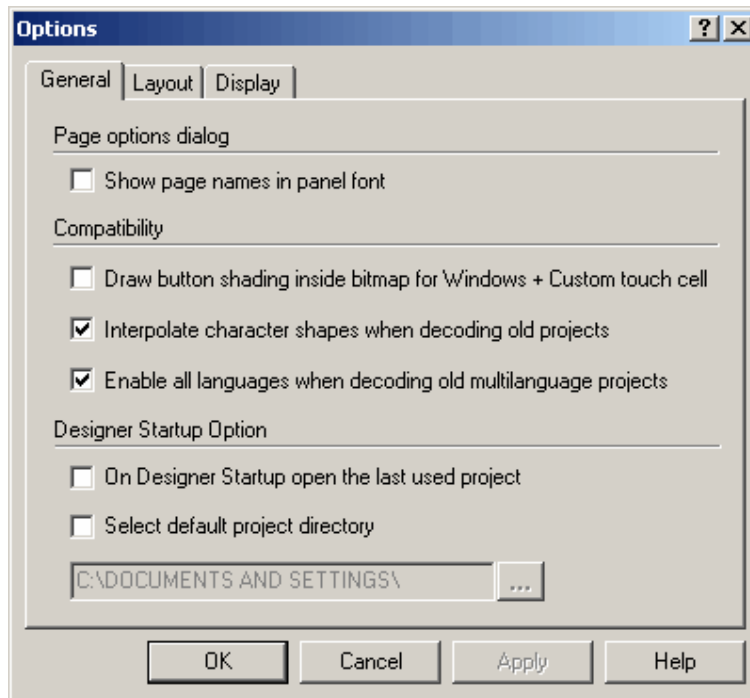

Selection Options from the Tools menu brings up the Layout Options dialog box. This dialog box contains two tabs, General and Layout.

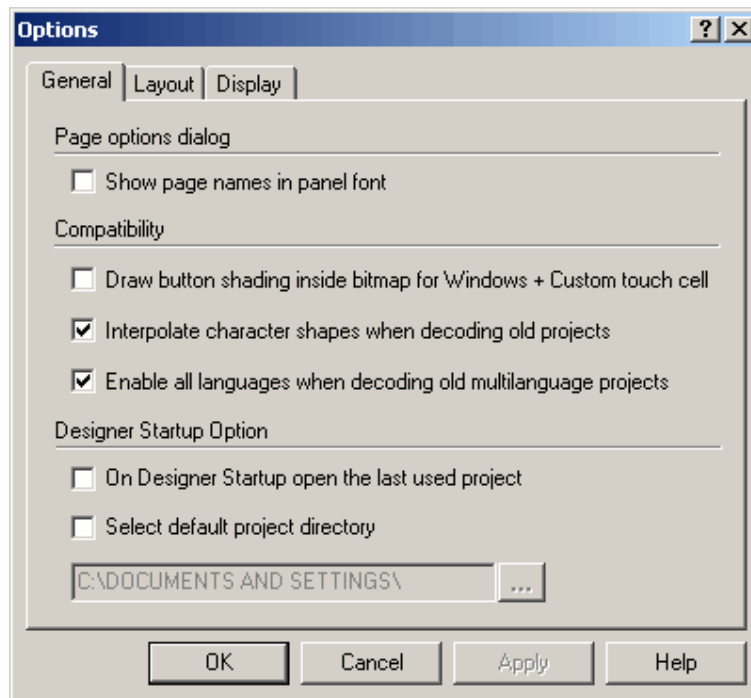
**4.8.167 General**

The General tab allows you to specify if the if the page names have to be displayed or not by the panel.

The "Show page names in panel font" option allows you to show the page names with the panel font inside the Page Options dialog.

The "Draw button shading..." option allows you to control if buttons inside bitmaps or custom touch cells have to be shaded or not.

The "Interpolate character shapes..." option controls how the character shapes created with previous version of Designer are to be converted into the new graphic format. By default the option is on, if you get a bad conversion, try to disable it and repeat the operation.

The "Enable all languages..." controls how the multilanguage texts created with previous version of Designer are to be converted into the new graphic format. By default the option is on, i.e. all languages are enabled, otherwise disables the text object for languages with empty texts.

When the "On Startup open the last used project" option is checked Designer will load at at start up the last used project automatically.

Using the "Select default project directory" you can specify the default project directory where the Designer files are stored

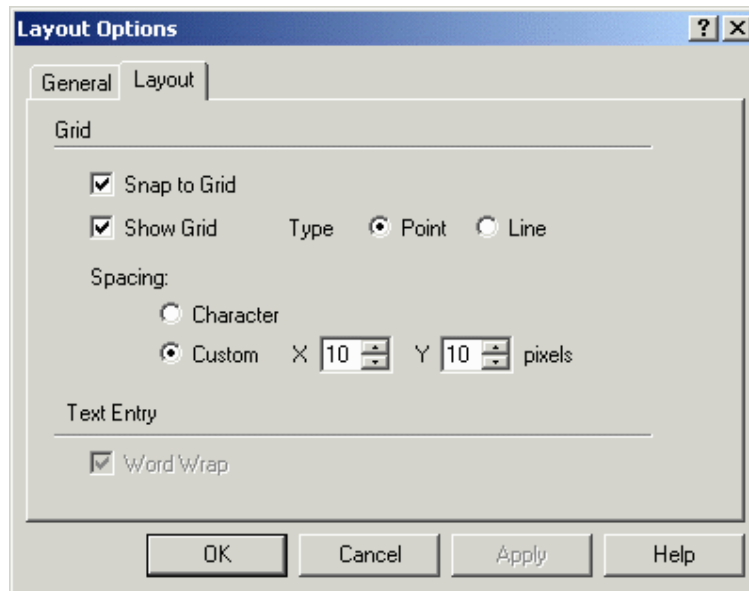
**4.8.168**    **Layout****4.8.169**    **Layout**

The Layout tab allows you to control the Grid and the Text Entry behaviours.

**4.8.170**    **Grid****4.8.171**    **Grid**

The options under the Grid section let you display a grid on the screen, align items with the grid, and set the spacing of the grid.

**4.8.172**    **Show Grid**

Check this box to display a grid on the screen for the current project.

**4.8.173**    **Snap to Grid**

Check this box if project items are to align with the grid.

**4.8.174**    **Spacing**

The grid spacing may be based on character size, or you may set a custom grid size by setting the number of pixels for the grid in both the X and Y directions.

**4.8.175 Text Entry**

Check the Word Wrap box under Tools - Options to enable word wrapping, which automatically continues a sentence on additional lines if it does not fit on the current line. If word wrapping is not selected, then the portion of any lines that are too long for the display will not be viewable.

**4.8.176 Advanced****4.8.177 Advanced**

Commands in the Advanced submenu on the Tools menu include:

Format SSFDC

Erase Protocols in Panel

Erase NiceFonts in Panel

FW Rescue Mode

Validate Project Data

Connect to Tags

Swap Protocols

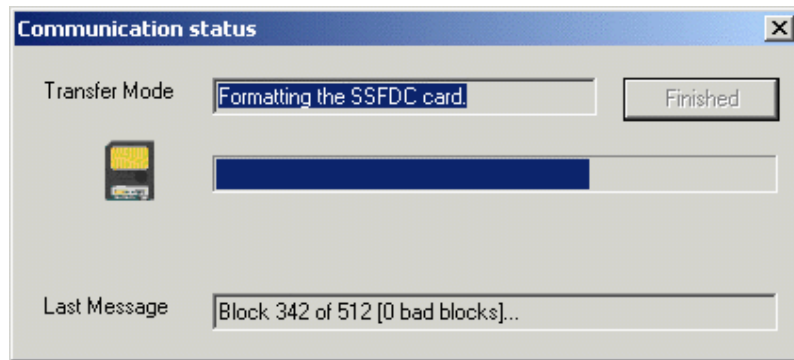
**4.8.178 Format SSFDC**

The SSFDC card comes formatted for use inside of a UniOP panel. If it becomes necessary to format the SSFDC card, the Format SSFDC command can be used.

This refers to a special feature that allows you to format the panel memory card using the UniLOD programmer. It is an external device for memory card programming via PC parallel port.

## 4.8.179 Erase Protocols in Panel

From the point of view of the UniOP panel a project consists of:

project data

graphics (optional)

enhanced fonts (optional)

Keypad Designer keyboards (optional)

protocol or communication driver

This command allows to you to delete, via the serial line link, ONLY the protocol part of the project. Without the protocol a panel cannot start in Operation Mode.

## 4.8.180 Erase NiceFonts in Panel

From the point of view of the panel Nice Fonts consist of files downloaded to the panel memory card. This command allows you to delete them via the serial line link.

## 4.8.181 FW Rescue Mode

UniOP panels use the boot file that resides inside the internal FLASH memory to load firmware code. When the internal boot file is corrupted or missing, the firmware file cannot be loaded and the UniOP panel display will remain off.

In this condition, it is necessary to use the FW Rescue Mode command to download a new copy of the boot file.

Note: Make sure that the Firmware Download flag on the Settings index tab within the Panel Setup dialog box is enabled. Otherwise the FW Rescue Mode command will be hidden.

After connecting the serial line of the UniOP panel to the computer, simply click on the FW Rescue Mode command from the Tools menu and follow the instructions that will appear on the computer.

The rescue procedure will ask you to turn the UniOP panel off, then back on.

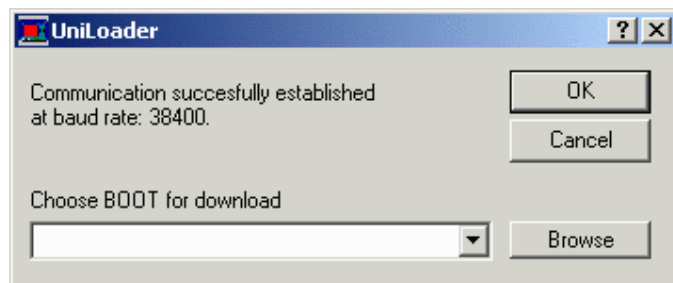

When communication is established, the rescue procedure will check the boot files that are inside the firmware directory on the computer and prompt you to begin downloading the most recent version.

After completing these operations, the UniOP panel will restart.

## 4.8.182 Validate Project Data

Validate Project Data is a command introduced to verify the consistency of a Designer project file and automatically fix any known problem. When a not valid object is found and there is no way for an automatic fix, the object is deleted from the project. A detailed log file with the list of the changes applied to the project is also generated and stored as "ProjectFix.log" into the working folder.

Warning:

Be sure to save a backup copy of your project before run this command.

## 4.8.183 Connect to Tags

The Connect to Tags command connects the active project with the selected tags database. This command checks the controller reference of each field in the project and compare it with the logical addresses from the selected tag dictionary linking the first hit in the tag database. If the controller reference is not found in the tags database, then the field will not be tied to any tag. If the same controller reference is found in the tags database twice, the second instance will never be tied.

Note:

This command is active only when no tags database is already linked to the active project.

## 4.8.184 Swap Protocols

Swap Protocols command is available only when the current project is double protocol enabled. Using this command you can swap the order of the Primary and Secondary drivers. This will physically result in a port swap on the panel between the two channels.

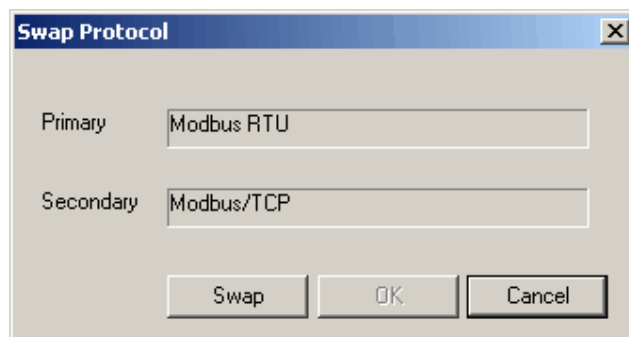



### 4.8.185 Replace Images

The Replace Image dialog box provides an easy way to work with the images of the currently opened project.

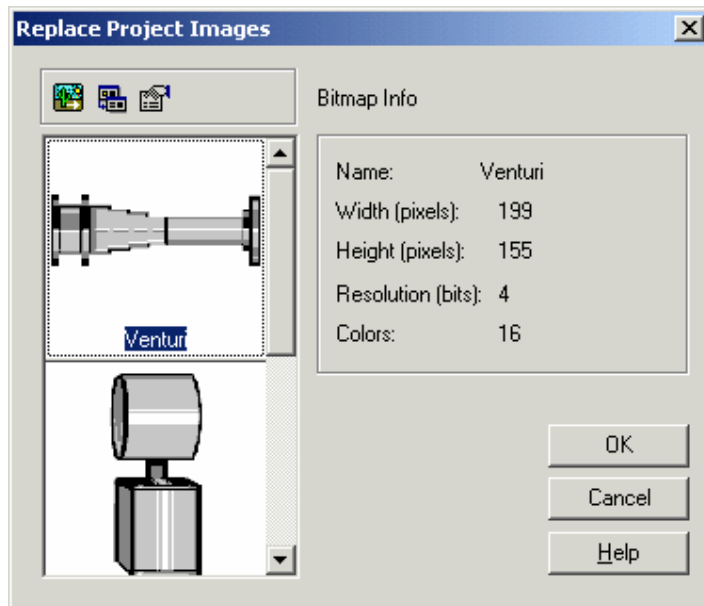

The user is provided with three toolbar buttons (i.e. Replace image, Replace all images, Edit Image) in order to manipulate/replace the images in the project. All the three commands can be invoked via context sensitive menu as shown below.

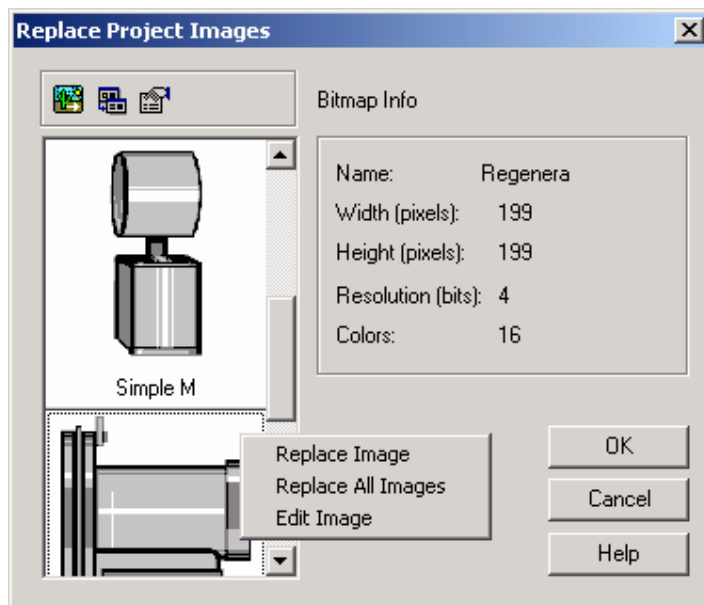

#### Replace image

When only one image of the project has to be replaced with another image Replace image command can be used. Once this command is invoked the open file dialog is shown from which the user can select the new image.

## Replace all images

By using this command the user can change all the images of the project at a single stretch. The Replace All command first gets the image directory and once the directory is selected by the user the below Confirm Images dialog is shown.

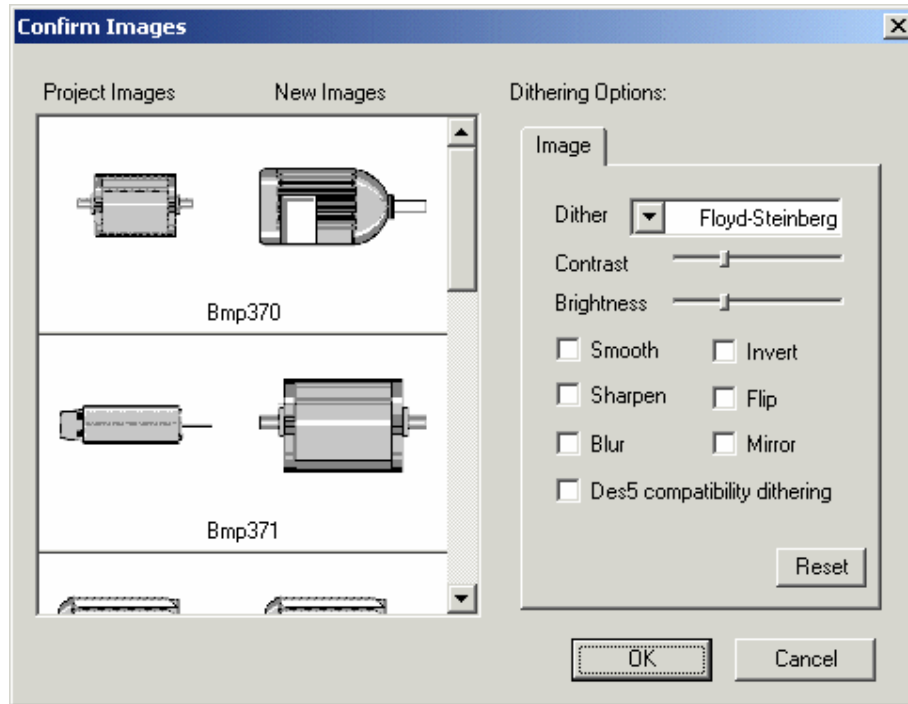

If there any discrepancy in images the concerned image can be individually replaced using Replace Image command.

Note :- By checking the Des5 compatibility dithering option user can simulate the Des5 dithering in Designer.

## 4.9 Window Menu

### 4.9.1 Window Menu

This chapter provides information about the Window menu. The Window menu provides choices in the appearance of project windows.

New Window

Cascade

Tile Horizontally

Tile Vertically

### 4.9.2 New Window

The New Window command opens a new, blank window. This option is currently disabled.

### 4.9.3 Cascade

Selecting Cascade from the Window menu displays all open windows in an overlapping fashion, with each new window opening lower and to the right of the previous window.

### 4.9.4 Tile Horizontally

Choosing Tile Horizontally from the Window menu displays all open windows simultaneously on the same screen, with each new window displayed below the other open windows.

### 4.9.5 Tile Vertically

Choosing Tile Vertically from the Window menu displays all open windows simultaneously on the same screen, with each new window displayed beside the other open windows.

## 4.10 Application Menu

### 4.10.1 Application Menu

This section provides information on the Application menu. The Application menu is the one appearing when the user right-clicks on the title area and provides access to familiar Windows<sup>TM</sup> commands for management the application itself.

Restore

Move

Size

Minimize

Maximize

Close

### 4.10.2 Restore

The Restore command on the Designer menu restores the project page to a previous appearance.

### **4.10.3 Move**

The Move command on the Designer menu makes it possible to move the Designer project screen for placement on the overall Designer screen.

### **4.10.4 Size**

The Size command on the Designer menu lets you easily resize the Designer project screen within the overall Designer screen.

### **4.10.5 Minimize**

The Minimize command on the Designer menu makes it possible to minimize the Designer project screen to an icon within the overall Designer screen. Minimize buttons in the top right corners of screens perform the same action.

### **4.10.6 Maximize**

The Maximize command on the Designer menu lets you maximize the Designer project screen to take up all possible space within the overall Designer screen. Maximize buttons in the top right corners of screens perform the same action.

### **4.10.7 Close**

The Close command on the Designer menu closes the current Designer project. You will be prompted to save the project if necessary. Close buttons in the top right corners of screens perform the same action, as does simultaneously pressing the Ctrl+F4 keys.

## **5 Workspace**

### **5.1 Workspace**

The status bar to the left of the main Designer screen provides information on project pages and lists various graphics and objects that can be placed in a project.

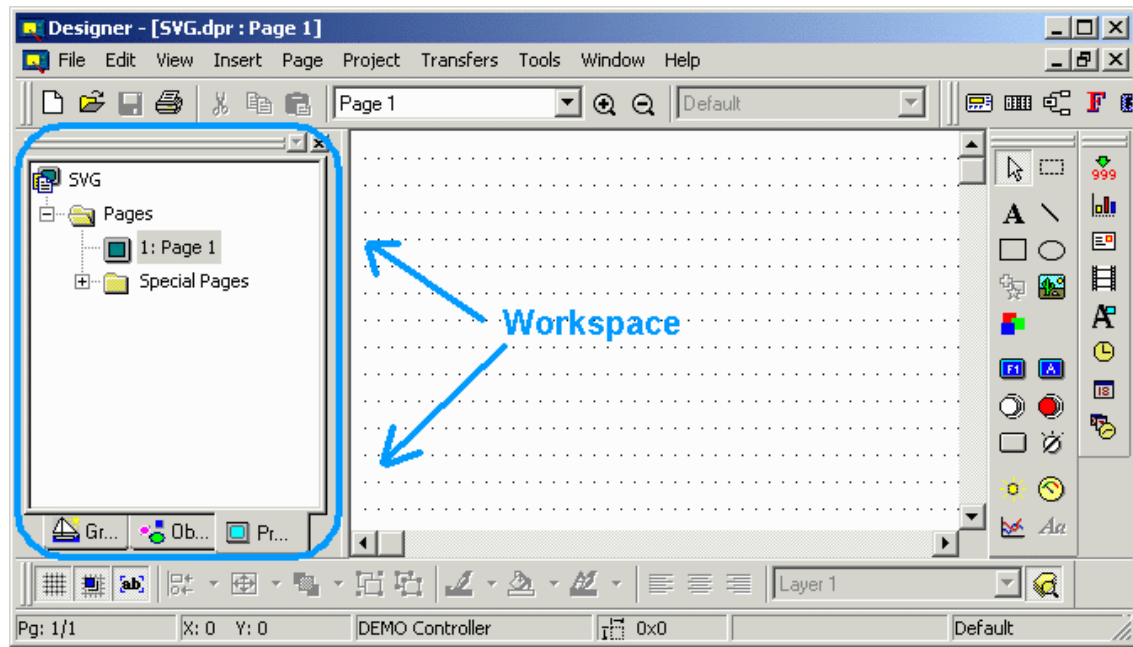

If Workspace is checked in the View menu, the workspace will be visible. The Workspace is composed of three tabs: Graphics, Objects, and Project.

The default position of the workspace is to the left of the main Designer screen, however the workspace can be moved anywhere on the Designer screen. To hide the workspace, uncheck it under the View menu. To make it visible again, simply check it again.

Note: Right-clicking in the frame of the workspace box brings up a number of options for viewing the workspace. Select Allow Docking to dock the workspace against any of the four sides of the application. If the check box is removed, then the workspace will act as a mini-window, which can be placed anywhere and resized. On the other hand, clicking Float in main window causes the workspace to occupy the entire application window and minimize the graphics view.

## 5.2 Graphics

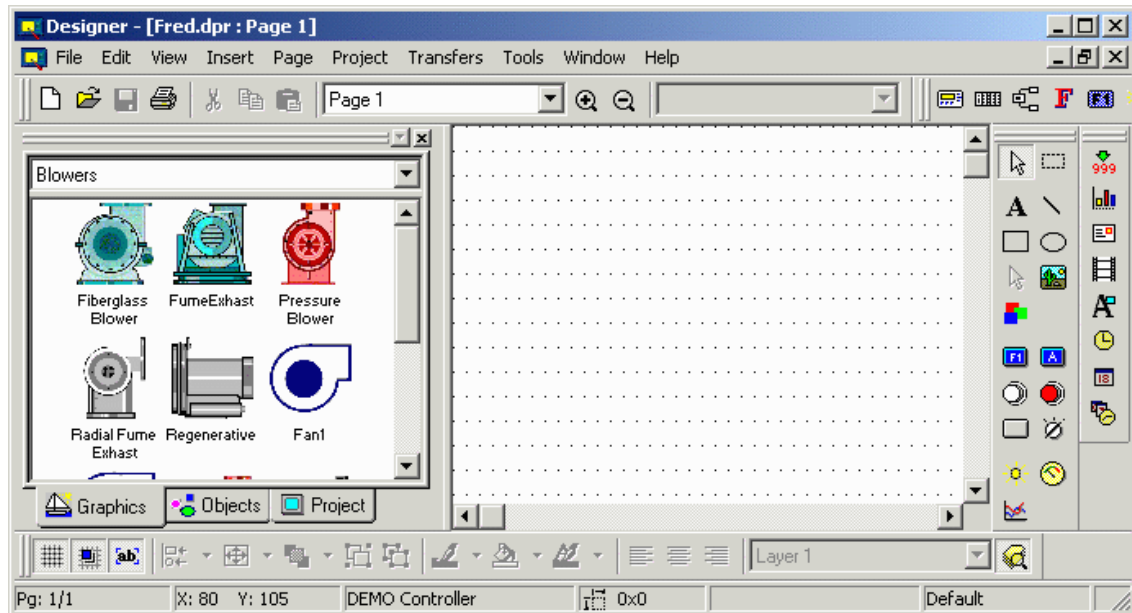

The project workspace can display commonly used bitmap graphics that can be easily imported into a project.

Click on the Graphics tab at the bottom of the workspace to view the graphics selections. Select a category of graphic (blowers, pipes, tanks, etc.) from the pull-down list at the top of the workspace. Commonly used graphics for that class of item will be shown in the workspace. Simply click on the selected item and drag it over to the place on the project page where it is to be inserted.

As the graphic is dropped into place the Bitmap Settings dialog box appears so that any necessary changes can be made to the graphic. Upon clicking OK, the graphic will appear on the project page. Should any further changes be necessary, click on the graphic once to select it (if it is not already selected), then right-click on the graphic and select Edit to go to the Bitmap Editor.

### 5.3 Objects

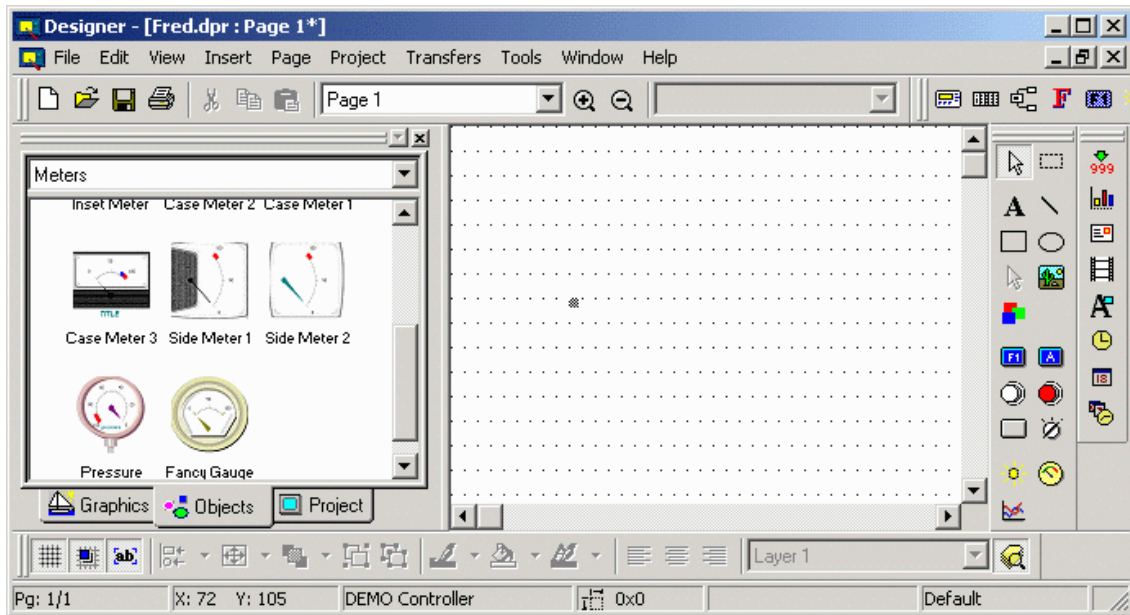

The project workspace can display commonly used objects that can be easily imported into a project. Click on the Objects tab at the bottom of the workspace to view various objects. Select a category of graphic (custom touch cells, dynamic graphics, meters, buttons, etc.) from the pull-down list at the top of the workspace.

Commonly used objects for that class of item will be shown in the workspace. Simply click on the selected item and drag it over to the place on the project page where it is to be inserted. Should any changes to the object be necessary, click on the graphic once to select it (if it is not already selected), then right-click on the graphic to go to the appropriate Properties dialog box.

## 5.4 Project

### 5.4.1 Project

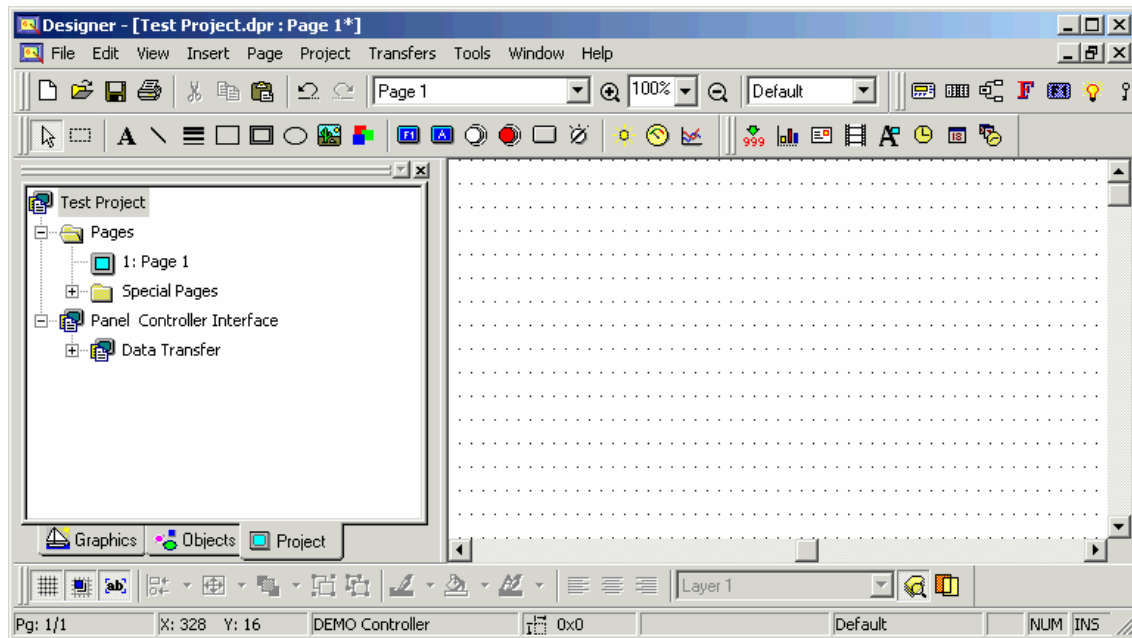

The project workspace can be used to display a tree of the currently open project.

Click on the Project tab at the bottom of the workspace to view various all the pages in that project. All pages are listed by title. To open a page in the project, simply double-click on that page in the project workspace.

### 5.4.2 Data Transfer

The Data Transfer feature lets you exchange data between two controllers or between registers within a single controller. A job refers to one complete data transfer. The data transfer configuration allows you to set the job execution mode, the source and destination references, the number of words to transfer.

Right click on Data Transfer item to add a new Data Transfer Job



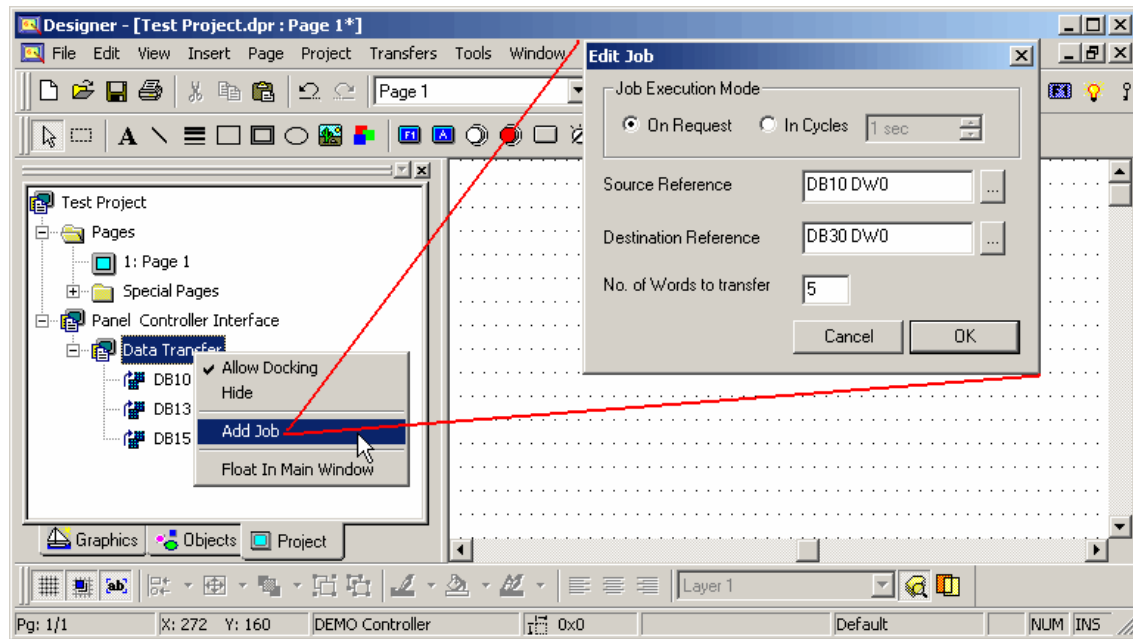

## Destination Reference

Clicking the "..." button under Destination Reference brings up the Data Field Properties dialog box where you can specify the register to be written to.

## Job Execution Mode

The Job Execution Mode box lets you select how the data is transferred, either On Request or In Cycles.

## Number of Words to Transfer

The maximum number of words for each job is 30.

## Source Reference

Clicking the "..." button under Source Reference brings up the Data Field Properties dialog box where you can specify the register to be read.

To Delete a Data Transfer Job simply right click on Data Transfer item and select Delete Job from the contextual menu.

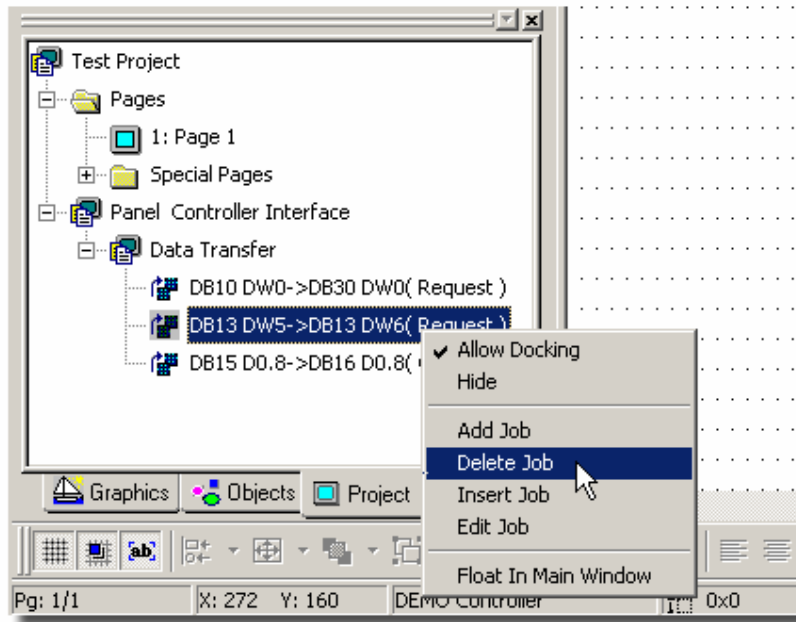

## 6 Basics

### 6.1 Basics

This section provides:

a Quick-Start tutorial,

a description of the Designer screen,

instructions on how to configure Designer to create a project,

instructions on how to create a new project using simple U/I elements and simple I/O fields,

instructions on setting up your project to generate a printed report, and

how to upload and download your project.

### 6.2 Designer Screen

#### 6.2.1 Designer Screen

The Designer software presents a screen that has elements familiar to anyone used to Windows<sup>™</sup>-based software.

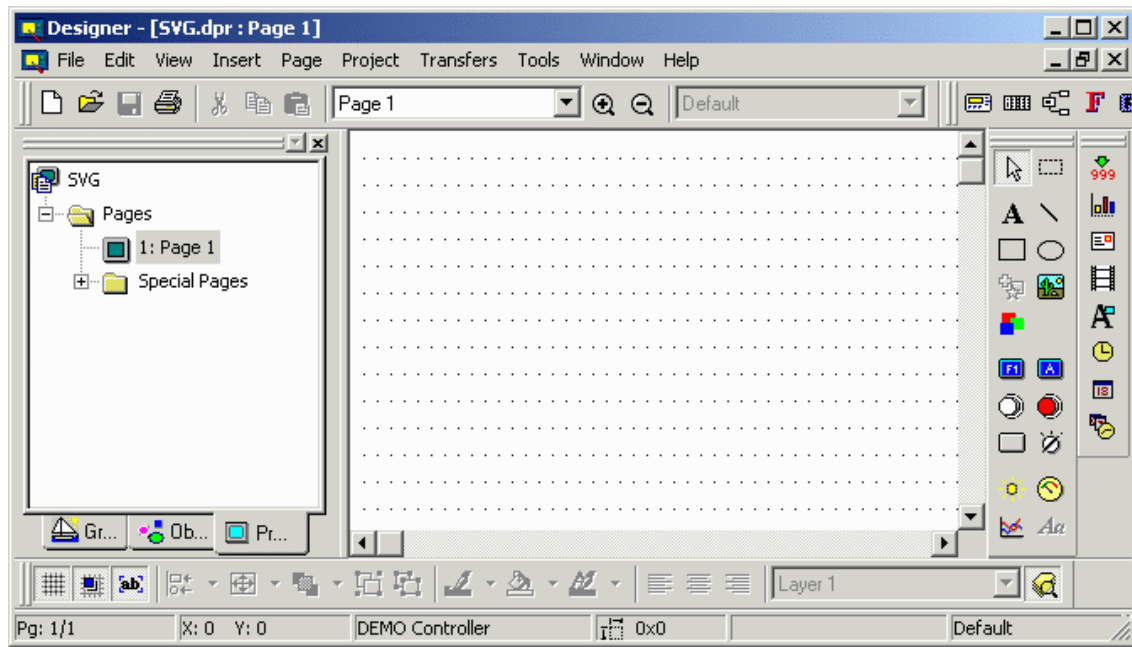

A title bar across the top of the screen shows the program, file name, and page number. Below the title bar is a menu bar with pull-down menus. Below the menu bar are toolbars with various icons that are shortcuts to commonly-used commands. A workspace in the lower left provides a project overview. The project screen in the lower right is the working area where project pages are viewed during development.

As is common for Windows<sup>™</sup>-based software, there are Minimize, Maximize and Close buttons in the top right corner.

The appearance of Designer may be customized to your particular needs by using the commands in the View menu.

Menu Bar

Toolbars

Workspace

Project Screen

Status Bar

Right-Click Menus

Tooltips

Getting Help

## 6.2.2 Menu Bar

The menu bar across the top of the Designer screen lists the pull-down menus available in Designer.

These include File, Edit, View, Insert, Page, Project, Transfers, Tools, Window, and Help. Each of these menus and the commands contained under them are described in the reference material.

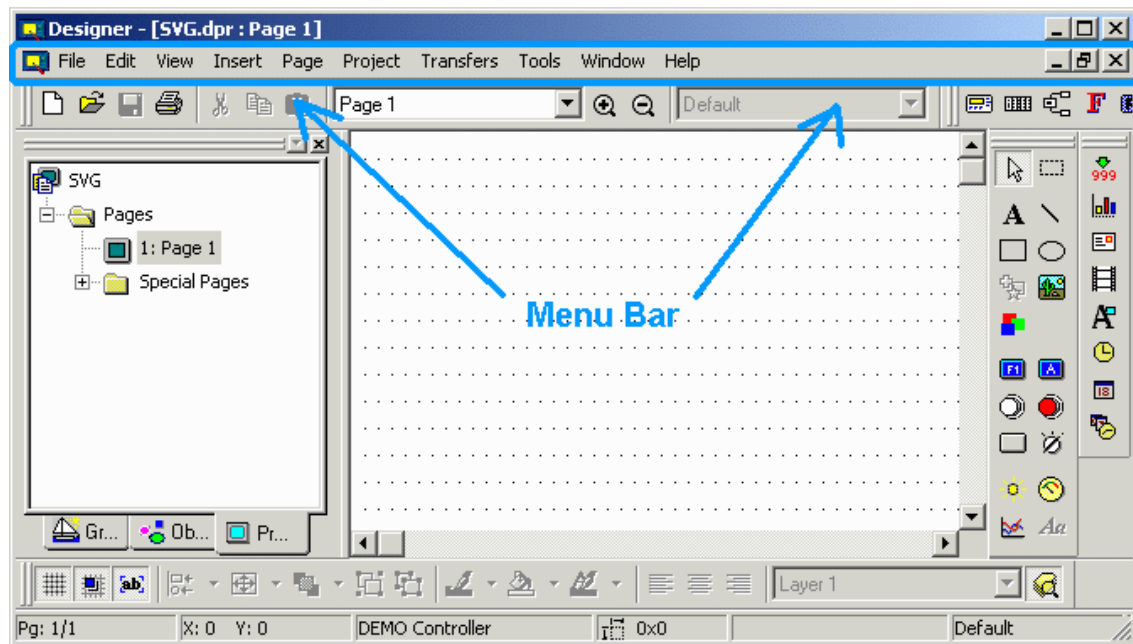

A Designer menu may also be present on the toolbar. Depending upon the selections made under the Windows menu, the Designer menu may appear at the top of the individual project screen rather than with the other menu selections across the top of the Designer screen.

Various features will be enabled/disabled depending on the panel model and firmware version of the panel that you have selected for the project. When you start a new project the previously used panel (in the previous Designer session) is used as default. Basically, menu items reflect the available functionality of the current panel for which you are defining a project.

## 6.2.3 Toolbars

Various toolbars may be displayed on the application area (in proximity of the borders).

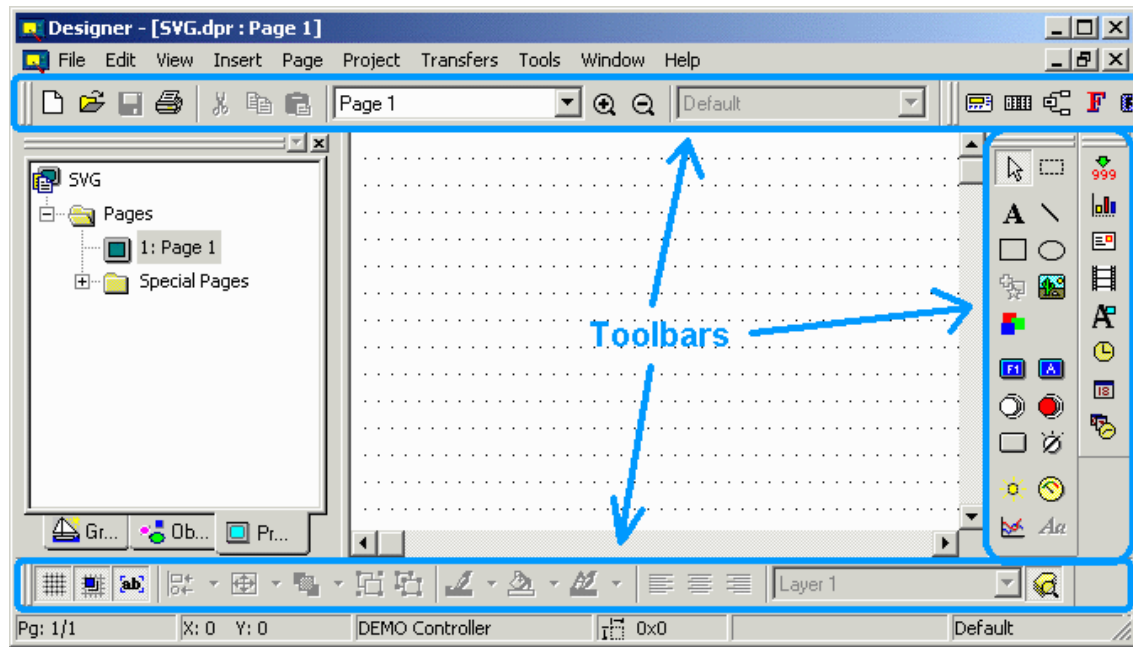

These may include the following:

Primary toolbar

Typically provides shortcuts to commonly used Windows™-type commands.

Secondary toolbar

Typically provides shortcuts to Designer project-level commands.

Full Screen toolbar

Typically provides shortcuts to viewing preferences.

Tools toolbar

Typically provides shortcuts to user-specified tools.

TouchScreen toolbar

Typically provides shortcuts to touchscreen-specific commands.

The appearance of the toolbars may be changed using commands under View - Toolbar. As is normal with Windows™ applications, toolbars can float or be docked. To undock a toolbar, click on the double bars on one edge of the toolbar (or simply double-click on the toolbar) and drag the toolbar to any position on the screen. To dock the toolbar, drag the toolbar so that the double bars on one edge touch the edge of the screen.

## 6.2.4 Workspace

The status bar to the left of the main Designer screen provides information on project pages and lists various graphics and objects that can be placed in a project. If Workspace is checked in the View menu, the workspace will be visible.

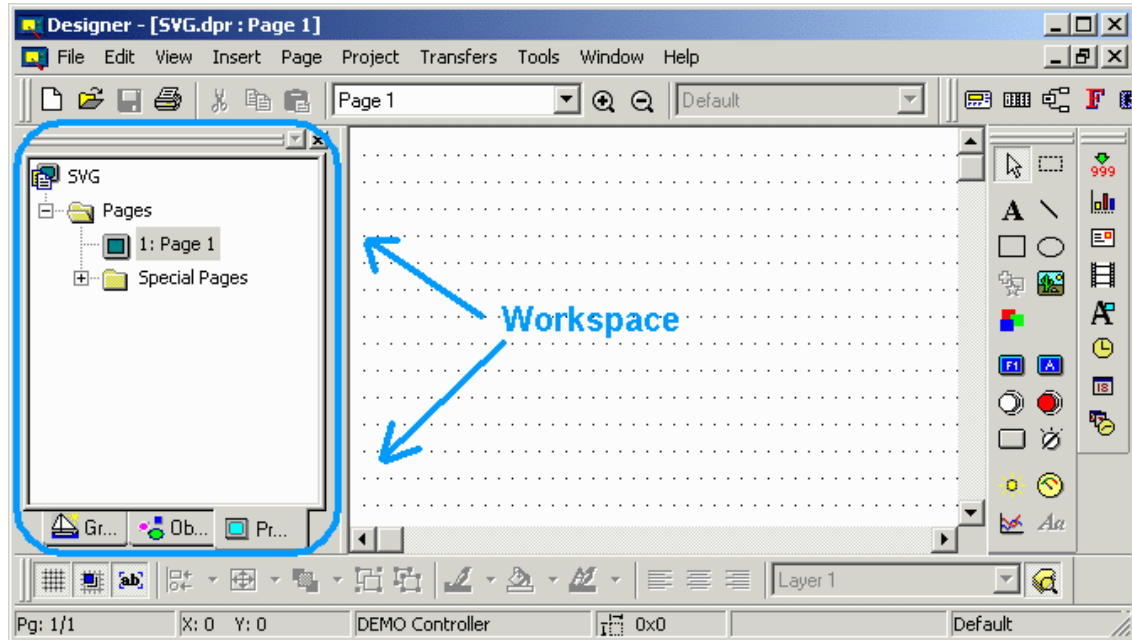

The default position of the workspace is to the left of the main Designer screen, however the workspace can be moved anywhere on the Designer screen. To hide the workspace, uncheck it under the View menu. To make it visible again, simply check it again.

Note: Right-clicking in the frame of the workspace box brings up a number of options for viewing the workspace. Select Allow Docking to dock the workspace against any of the four sides of the application. If the check box is removed, then the workspace will act as a mini-window, which can be placed anywhere and resized. On the other hand, clicking Float in main window causes the workspace to occupy the entire application window and minimize the graphics view.

## 6.2.5 Project Screen

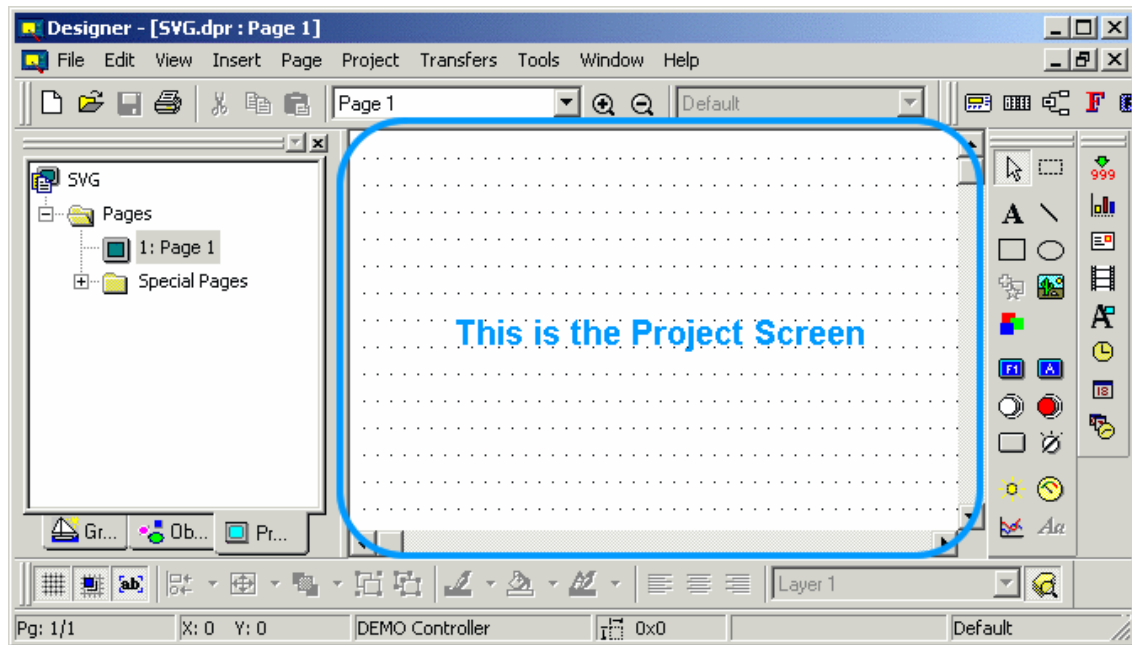

The project screen is the main work area where project pages are created and modified.

## 6.2.6 Status Bar

The status bar across the bottom of the Designer screen provides interactive information on various screen items.

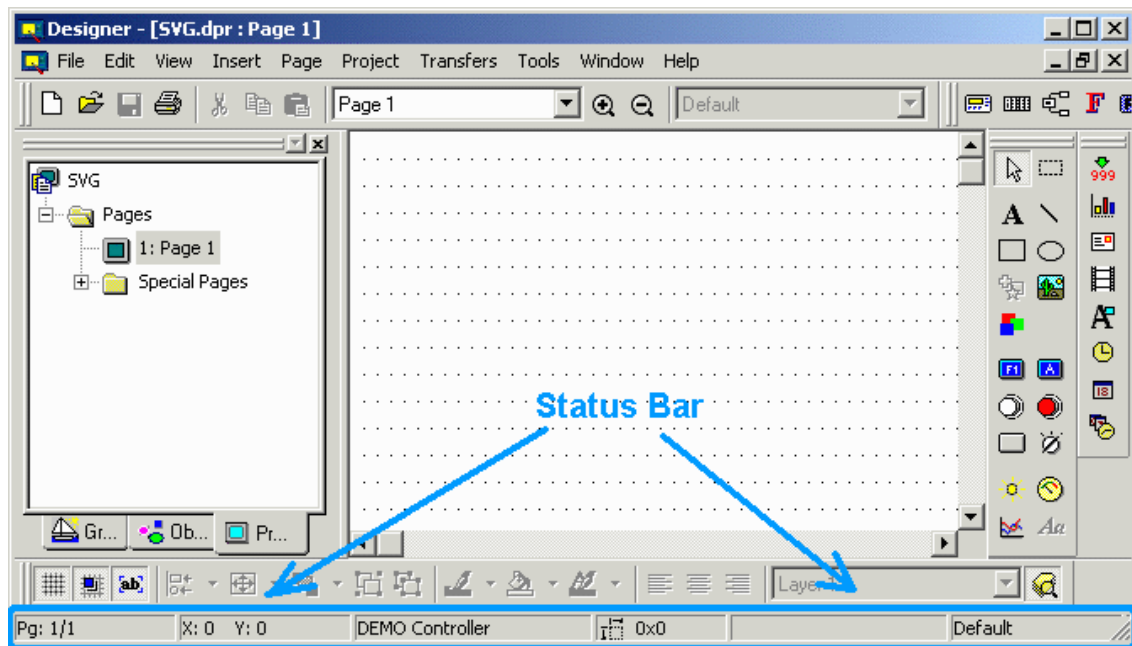

If Status Bar is checked in the View menu, the status bar will be visible across the bottom of the screen. To hide the status bar, uncheck it under the View menu. To make it visible again, simply check it again.

### 6.2.7 Right-Click Menus

Right-click menus are available to keep commonly-used commands conveniently close at hand. Simply left-click on an item or object on a page to select it, then right-click to activate the right-click menu for that item or object. Menus are customized for the particular item or object selected, but common menu items include:

#### Cut

The Cut command removes the selected item from the current page and places it on the Windows™ clipboard. This action can also be activated by pressing the Ctrl+X keys.

#### Copy

The Copy command makes a copy of the selected item from the current page and places it on the Windows™ clipboard. This action can also be activated by pressing the Ctrl+C keys.

#### Paste

The Paste command places items from the Windows™ clipboard onto the current page at the current position of the cursor. This action can also be activated by pressing the Ctrl+V keys.

#### Select Covered Object

If one object is on top of another, this command selects the object underneath. This is handy if it is difficult to left-click on the bottom item to select it.

#### Order

Sets the position of an object in relation to other objects that are covering it and/or covered by it

#### Align

If there are two or more currently selected objects/items, this command allows to align them.

#### Group / Ungroup

If there are two or more currently selected objects/items, these command allow to respectively group / un-group them. Group will always be created in the current layer. The current layer name is always displayed in the edit control part of the active layer combo box.

#### Edit

Brings up the Bitmap Editor.

#### Properties

Brings up the Properties dialog box appropriate for that type of object or item, where settings for the object or item can be changed.



### 6.2.8 Tooltips

As part of the Designer software's help system, help prompts are available to identify the various icons. These help prompts are called tooltips.

To view a tooltip, simply place your cursor over an icon and hold it there for a few seconds without clicking. A small box will appear with a brief description of the icon.

Tooltips are enabled by default. If you should need to disable or enable tooltips you may do so under Tools - Customize. On the Toolbars tab is a checkbox for Show Tooltips.

### 6.2.9 Getting Help

If you are unsure about the meaning of an item or unsure what to do next, help is never far away. Many dialog boxes include a Help button, which you can press to read information about that dialog box.

Help text is also always available under the Help menu.

## 6.3 Designer Setup

### 6.3.1 Designer Setup

The first thing you should do upon starting the Designer software is to configure Designer to work with your particular panel and controller.

In Panel Setup you input all the parameters such as panel model, firmware version, available memory, etc., before creating any projects. Then use Configure Controller to specify the type and model of controller to be used.

Note: The panel must be in Configuration Mode in order to communicate with the PC.

### 6.3.2 Transfer Settings

To verify the transfer settings between the PC and your panel, check under Transfers - Options - Serial ports for communication parameters between Designer and the panel.

All UniOP panels are capable of communicating with a PC at a speed of at least 9600 baud. However, several panels will communicate at speeds of 19,200 baud and 38,400 baud. With some Pentium-based computers, a speed of 19200 baud may prove to work more efficiently than 38400 baud.

Set the baud rate, parity, data bits and stop bits to be used in communication between the panel and the PC. To change the settings, click on the selection arrows and pick a different setting from the pull-down lists. For further information on these options, see the Port Settings section.

Note: The communication parameters that you set up here need to match the communication parameters of your modem.

Note: Check the Use modem check box under Transfers - Options - Serial ports ONLY if you are using a modem to communicate between your PC and the panel. This is not necessary if you have a cable between the PC and panel, thus the Use modem box should not be checked.

Note: Sometimes other programs will "take up" your PC communications port. For example, if you have a Palm Pilot, it automatically loads some files upon power up of your computer that "take up" the communications port. In the bottom right hand corner of your computer monitor, make sure that all programs that may take up a communication port are closed.

### **6.3.3 Controller Selection and Setup**

### **6.3.4 Controller Selection and Setup**

Before creating your first project using the Designer software, it is worth checking the controller setup to make sure that it reflects the controller that you will be using.

Using the Get Panel Resources command from the Transfers menu will most likely set the controller settings to be compatible with your system, but sometimes changes are necessary.

Configure Controller

Controller Setup

### **6.3.5 Configure Controller**

Different controllers require different parameters in order to communicate properly with the operator interface panel.

Verify the controller by choosing Configure Controller from the Project menu. Make sure that the listed controller is the type of controller driver that you will be using. If it is not, click the "..." button to select a different driver from a list.

### **6.3.6 Controller Setup**

After selecting a controller by clicking the "..." button under Project - Configure Controller, you should verify that the controller model is correctly specified. This can be accomplished by clicking the Controller Setup button from the Select Controller dialog box. This will bring up the Controller Setup dialog box where you can select the specific controller model that is being used.

The communication parameters are set automatically when the controller selection is made. However, if there is a need to change the default settings, you may press the Comm button in the Controller Setup dialog box (available for certain controllers). This will bring up the Communications Parameters Setup dialog box where you can check the parameters used in

panel-to-controller communication, including baud rate, parity and stop bits. To change the settings, click on the selection arrows and pick a different setting from the pull-down lists.

### **6.3.7 Panel Selection and Setup**

### **6.3.8 Panel Selection and Setup**

Before you begin working on a particular project, you need to specify the type of display that your panel contains. The physical size of the screen, as well as its type (backlight LCD, passive color) must be specified.

Failure to do this may result in the loss of text and data when you attempt to download the project file into the panel. This can be done automatically using the Get Panel Resources command from the Transfers menu, or manually using Panel Setup from the Project menu.

### **6.3.9 Get Panel Resources**

The easiest way to set up Designer to work with your panel is to use the Get Panel Resources command in the Transfers menu. This command prompts the Designer software to automatically retrieve the configuration of the connected panel. This includes the physical size of the screen, as well as its type (backlight LCD, passive color).

Note: In order to use the Get Panel Resources feature, the target panel must be connected to the PC, the transfer parameters must be correctly set, and the panel must be in Configuration Mode.

### **6.3.10 Panel Setup**

### **6.3.11 Panel Setup**

After using the Get Panel Resources feature, it is recommended to verify the panel settings. Select Panel Setup from the Project menu (or click on the Panel Setup icon in the toolbar). This brings up the Panel Setup dialog box where you can configure the software for the panel that you are using.

You can verify the panel model, memory, and firmware version, specify the time and date format that the panel will display, identify the address of an Ethernet board if one is in use, specify communication settings, set the panel up for remote passthrough, set time out periods, and set panel upload protection, if necessary.

Panel Model

Panel Time/Date Settings

Passthrough Settings

## Miscellaneous Panel Settings

### 6.3.12 Panel Setup

After using the Get Panel Resources feature, it is recommended to verify the panel settings. Select Panel Setup from the Project menu (or click on the Panel Setup icon in the toolbar). This brings up the Panel Setup dialog box where you can configure the software for the panel that you are using.

You can verify the panel model, memory, and firmware version, specify the time and date format that the panel will display, identify the address of an Ethernet board if one is in use, specify communication settings, set the panel up for remote passthrough, set time out periods, and set panel upload protection, if necessary.

Panel Model

Panel Time/Date Settings

Passthrough Settings

Miscellaneous Panel Settings

### 6.3.13 Panel Model

If the correct panel model is not shown, you can choose a different panel model from the Panel Setup dialog box on the Project menu.

From the Panel Model tab click on the down arrow located to the right of the Panel Model window. A drop-down list will appear that shows the available panels that can be selected. Single-click the left mouse button on the name of the panel that you will be using. The page editor workspace will change in order to reflect the available screen area on the selected model. Similarly, you can change the specified panel memory and firmware if necessary.

### 6.3.14 Panel Time/Date Settings

Click on the Settings tab in the Panel Setup dialog box to set the time and date formats. Pick the format that you prefer to use in your project from the pull-down lists.

### 6.3.15 Passthrough Settings

If you wish to be able to put your UniOP panel remotely into either Configuration Mode or Operation Mode via a modem, under Mode on the Passthrough tab (under Project - Panel Setup) click on the button for Remote Hardware passthrough. Otherwise select Hardware passthrough.

In the Request boxes enter any commands necessary to start or stop remote passthrough mode, or to put the panel into Configuration Mode. Likewise, you can enter the response that you will receive back from the panel in the Response boxes.

Note: Your UniOP panel must contain firmware version 4.10 or later to use the Remote Hardware feature.

Note: Configuring Remote Hardware passthrough under Panel Setup enables the Remote passthrough command on the Transfers menu.

Note: When remote passthrough mode has been activated, the UniOP panel does not communicate with the controller and the dynamic data displayed on the screen may no longer be correct. It may be useful to inform the user when the passthrough option is active. To do so, create a numeric/ASCII, bargraph, or message data field under Insert - Data Fields. Set the Reference type as Variable, click the "..." button, and select the Control Variable Data Type as Passthrough Status. This variable can take on two values; zero meaning that passthrough is not active, one meaning that passthrough is active.

### **6.3.16 Miscellaneous Panel Settings**

Under the Miscellaneous tab of the Panel Setup dialog box (in the Project menu) you can configure several different panel parameters. Selecting any of the checkboxes enables the entry boxes associated with those selections.

The Panel Upload Protection feature lets you password protect the project file so that unauthorized uploads cannot occur. You can enter a case-sensitive password of up to eight characters.

## **6.4 Creating a Project**

### **6.4.1 Creating a Project**

Before starting a new file for a new panel, please make sure that you have configured Designer to work with the particular panel and controller that you will be using. See the sections on Transfer Settings, Controller Selection / Set Up, and Panel Selection / Set Up for instructions on performing these tasks.

Creating a New File

Selecting a Font

Inserting Page Objects

Saving a Project File

Memory Used by the Project File

### **6.4.2 Creating a New File**

To create a new project, select New from the File menu, click on the New icon in the toolbar, or press the Ctrl+N keys.

This opens the New File dialog box. Enter a name for the new project and select the file location on the PC where the project file is to be stored. Click on an icon to identify the type of project file to be created. Click OK.

Note: Unless otherwise specified, Designer files are assumed to have the .dpr extension.

### **6.4.3 Selecting a Font**

To choose a new panel font, select the Panel Font icon from the toolbar or choose Edit - Fonts - Panel Font.

The Select Font dialog box appears with a drop-down list showing the available fonts for the current panel. Click on name of the font to be used. Select a font size.

Note: When the area defined for a text box is small, only the sizes that can fit inside the selected area are enabled.

### **6.4.4 Inserting Page Objects**

Insert text on the page by clicking on the screen and typing the text.

Data fields, touch cells, etc., can be placed on the page by using the commands on the Insert menu.

Graphics and objects may be easily placed on the page by dragging them from the workspace. Simply click on a tab in the workspace, click on a graphic or object, and drag it onto the page. Once placed on the page, you may move it, align it, resize it using the "handles" around it, or edit it.

### **6.4.5 Saving a Project File**

To save your new project, select Save from the File menu (or click on the Save icon in the toolbar).

The cursor will be momentarily replaced with an hourglass while the file is being saved. If the application has not been named, the Save As dialog box will appear.

The Save As dialog box can also be used to save your project under a different name. This dialog box shows the current directory path and the current filename. A new name and path may be entered, or the default parameters may be accepted. If the extension is omitted, ".dpr" is assumed. If a file of the same name already exists in the selected directory, you will be prompted to confirm the Save As operation in order to overwrite the existing file.

### **6.4.6 Memory Used by the Project File**

You can determine how much memory is used by the current project file by selecting Memory Use from the Project menu.

A dialog box will appear that contains information on the amount of memory that is used by the project file, how many bytes of recipe data are contained within the project file and the amount of memory used by the graphic information (bitmaps and touch cells) in the project file.

## 6.5 Printing

You can use Designer to configure your UniOP panel to print reports either cyclically or upon a trigger event. You can define report formats and timetables upon which a report is printed, configure a key or touchcell to print a report, or request a printout by using the Interlock Mailbox.

Note: In order to use these print features, your panel must contain firmware version 4.10 or higher.

Information on setting up a new printer, printing reports, and a printer setup example are provided.

## 6.6 Project Upload and Download

When your project is completely designed, you need to transfer it from your PC to your UniOP panel. A data transfer from your PC to a UniOP panel is termed a download.

To download data, select Download from the Transfers menu, click on the Download icon in the toolbar, or press the F2 key.

Note: The panel must be in Configuration Mode in order for the download procedure to work.

With some models it is also possible to download a project to an SSFDC memory card, if you have such a card installed in your system. To download to an SSFDC card, select Download to SSFDC from the Transfers menu or press the F6 key.

From time to time, you may wish to transfer an existing application from a UniOP panel to your PC. This is termed an upload. To upload data, select Upload from the Transfers menu, click on the Upload icon in the toolbar, or press the F3 key.

## 6.7 Simple Data Fields

Data fields are those items that the Designer software uses to display information from the controller. These dynamic data items come in the form of numeric fields (which can be displayed in numeric format or in ASCII format), bargraphs, message fields, attributes, dynamic graphics, time, and date fields.

These fields can be created by either selecting one of the seven types of fields from the Data Fields submenu in the Insert menu or by clicking on the various data field icons in the toolbar. This brings up the data Field Properties dialog box for the appropriate data field type.

For most data fields it is possible to specify the size and style of the data field, as well as the controller reference location. Depending upon the type of data field, it may be possible to specify the data format, the range, and whether not to apply scaling to the data. Designer uses placeholders to indicate the presence of data fields on a project page. These placeholders include:

Data Field Type	Placeholder
Numeric	9's
ASCII	A's
Bargraphs	sample bargraph
Message Fields	M's
Attributes	None
Dynamic Graphics	sample graphic
Time Fields	24:00:00 (depending on time format)
Date Fields	dd/mm/yy (depending on date format)

A number of examples are available to help you better understand the data field creation process.

Numeric Data Field Example

ASCII Data Field Example

Bargraph Example

Message Field Example

Attribute Example

Dynamic Graphics Example 1

Dynamic Graphics Example 2

Time Data Field Example

Date Data Field Example

## 6.8 Simple Touch Cells

A touch cell allows a panel user to interact with the panel. The user is able to touch a panel in an indicated position and receive a visual cue. The various types of touch cells available and their functionality are:

**Panel Key Button:** Used for creating a touch cell as a panel key (i.e., Enter). Panel keys represent all of the function keys, numeric keys, and arrow keys, as well as the help key, the clear key, the enter key, the +/- key, and the decimal point key. An example of creating a panel key button is provided.

**ASCII Key Button:** Used for creating a touch cell as an ASCII character. An example of creating an ASCII key button is provided.

**Push Button:** Used for creating a touch cell as a push button. These push buttons mimic mechanical push buttons in that one logic value represents open contacts and another logic



value represents closed contacts. An example of creating a push button is provided.

**Illuminated Push Button:** Used for creating a touch cell as an illuminated push button. The only difference between an illuminated pushbutton and a pushbutton is that the face of the illuminated pushbutton can reflect the status of a bit in the PLC. An example of creating an illuminated push button is provided.

**Selector Switch:** Used for creating a touch cell as a 2, 3 or 4 position selector switch. An example of creating a selector switch is provided.

**Indicator Light:** Used for creating an indicator lamp. An example of creating an indicator light is provided.

**Generic Command Button:** Used for creating a touch cell as a panel key (i.e., Enter), macro command (i.e., show alarm list), or ASCII character. An example of creating a generic command button is provided.

A touch cell can be used to write to a controller. Keyboard Macro Editor commands make this an easy task. An example of doing this is provided.

To insert a touch cell click the appropriate touch cell icon on the toolbar or select a type of touch cell from the Touch Cells submenu in the Insert menu, then use the cursor to define the area in which the touch cell is to be placed. A dialog box will appear where the touch cell may be configured.

## 7 Advanced

### 7.1 Automatic Firmware Upgrade Procedure

#### 7.1.1 Automatic Firmware Upgrade Procedure

New UniOP panels that contain the T2000 board are able to accept new firmware files through the serial line or through the SSFDC memory card.

For these panel models, the firmware files can be stored in the SSFDC memory card. There are four kinds of firmware files that can be stored in the SSFDC memory card. They are called "Boot", "Firmware", "MIPS Code" and "MIPS service" files.

A copy of the Boot and the Firmware files is also stored inside the internal panel FLASH memory. Storing a copy of these files inside the SSFDC card is not mandatory, but it is necessary when the internal FLASH memory must be updated.

A copy of the MIPS Code file must always be stored in the SSFDC memory card. In fact, this code is always loaded from the SSFDC memory card when the UniOP panel switches from the Configuration Mode" state to the Operating Mode state.

MIPS Service is not necessary for normal panel operation. It is necessary only for running in Service Mode.

Information is provided on the following topics:

Procedure to Upgrade the Internal Flash Memory

Check Firmware Versions

Firmware Files Directory

FW Rescue Mode

### 7.1.2 Procedure to Upgrade the Internal Flash Memory

To check the firmware versions that are stored inside the panel memory, it is necessary to put the panel in Configuration Mode and hold the Up-Arrow key for 2 seconds. A table similar to the one shown below will appear:

```
RELEASE.VERSION UPGRADE
          FLASH  SSFDC
Boot     04.30W  04.35D.0001
Fw       04.35D  04.35D
```

```
Press Enter to continue...
```

The FLASH column shows the active firmware version. The column SSFDC shows the version stored inside the SSFDC card. After pressing the ENTER key, the message shown below will appear.

```
Press Up Arrow to Update...
...or wait to leave unchanged
```

Pressing the Up Arrow key will cause the firmware upgrade procedure to start. Waiting for 2 seconds without pressing any keys will cause the procedure to abort without substituting the active firmware files.

### 7.1.3 Check Firmware Versions

Designer will enable the download features, accessible from the Transfers menu, when a panel model with the T2000 board is detected. Note that this menu item is not visible when the selected panel does not support the download features.

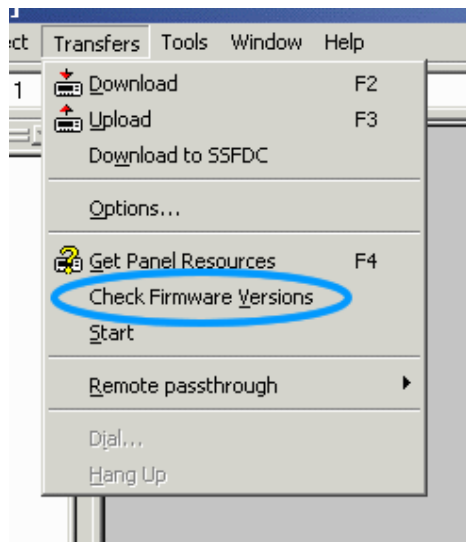

Download features can be enabled manually from the Settings index tab within the Panel Setup dialog box. Manual settings are necessary when a real panel is not physically connected to the PC and a Get Panel Resources command cannot be executed.

Correct setting of the Firmware Download flag is necessary to give Designer the necessary information required to correctly calculate the SSFDC memory used, taking into account the size of the firmware files.

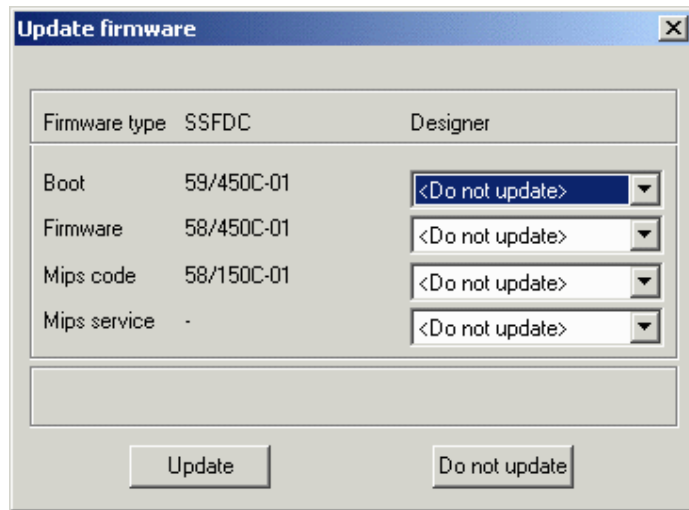

After exchanging information with the panel to detect the version of the firmware files that are inside the SSFDC memory card, the above dialog box is displayed. The left column displays the versions of the firmware files that are located in the SSFDC memory card. The right column displays versions of firmware files ONLY if the user's computer contains a newer version. If a newer version is not detected, <Do not update> will be displayed.

#### Update

This will start the download procedure. It does nothing when all of the Designer fields contains the <Do not update> strings. Please note that after updating the firmware files inside the panel SSFDC memory, it will be necessary to upgrade the panel's FLASH memory as previously described.

Do not update

Use this button to exit from this dialog box without updating the firmware files.

Note: Designer checks the firmware version before beginning any download operation. When an old firmware file version is detected inside the panel, the above dialog box is displayed to give the user a chance to upgrade the firmware file.

## 7.1.4 Designer Firmware Files Directory

The setup procedure installs a Firmware subdirectory inside the Designer working directory. This directory will contain all the necessary firmware files used by Designer to check and update the panel SSFDC memory card.

New firmware files have to be copied inside this directory to be accessible from Designer.

## 7.1.5 FW Rescue Mode

UniOP panels use the boot file that resides inside the internal FLASH memory to load firmware code. When the internal boot file is corrupted or missing, the firmware file cannot be loaded and the UniOP panel display will remain off.

In this condition, it is necessary to use the FW Rescue Mode command to download a new copy of the boot file.

Note: Make sure that the Firmware Download flag on the Settings index tab within the Panel Setup dialog box is enabled. Otherwise the FW Rescue Mode command will be hidden.

After connecting the serial line of the UniOP panel to the computer, simply click on the FW Rescue Mode command from the Tools menu and follow the instructions that will appear on the computer.

The rescue procedure will ask you to turn the UniOP panel off, then back on.

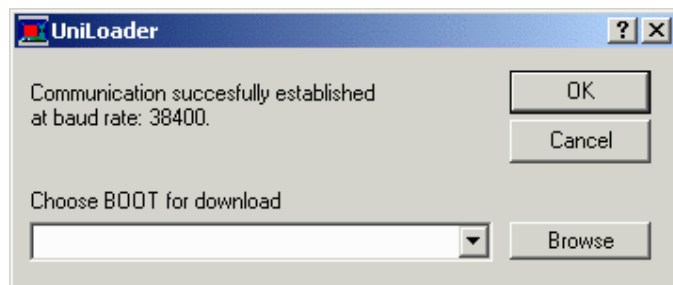

When communication is established, the rescue procedure will check the boot files that are inside the firmware directory on the computer and prompt you to begin downloading the most recent version.

After completing these operations, the UniOP panel will restart.

## 7.2 Double Protocol

### 7.2.1 Double Protocol

A single UniOP panel can communicate with Controllers simultaneously using different communication protocols. Configuring UniOP panels to support such operation is easy.

Multi-protocol support is provided by the Designer software, and is natural and easy to learn and use.

Different controllers are connected to the UniOP panel in different ways. Some are connected through a serial line (either RS232, RS422, RS485 or current loop), other through an Ethernet-based LAN using UDP/IP or TCP/IP protocol stack, and still other can be connected to the UniOP only after a custom communication module is plugged into it.

Most UniOP models are delivered with two serial ports. The PLC port supports RS232, RS422, RS485 and current loop communication. The PC/Printer port supports only RS232 communication.

The AUX port can be used for various purposes, depending on the type of the communication module plugged into the UniOP. If this is one of the Ethernet modules (TCM10, SCM11), the AUX port is used as the Ethernet port. But other communication modules can be plugged in, enabling connecting the UniOP to a wide diversity of controllers.

Of course, except for the necessary hardware needed to establish communication to a particular controller, an adequate Controller Driver has to be present in the Designer for Windows software. In the multi-protocol configuration case, drivers for both communication protocols will have to be available.

When the UniOP communicates with one or more controllers using only one communication protocol (single-protocol configuration), then, if this protocol is a serial protocol, the controllers are connected to the PLC port of the UniOP panel. Of course, if the protocol is a non-serial protocol (e.g. Ethernet), an adequate communication module must be plugged into UniOP and then the controllers must be connected to the AUX port.

When configuring the UniOP to communicate with controllers using simultaneously two communication protocols (multi-protocol configuration), distinction must be made between the First Communication Driver (used to communicate using the First Protocol) and the Second Communication Driver (used to communicate using the Second Protocol). It is important to remember the following rules for serial drivers:

First Driver always communicates with the controllers over the PLC port

Second Driver always communicates with the controllers over the PC/Printer port.

Of course, if any of the protocols is a non-serial protocol, its Driver will use the AUX port instead.

Although not many, it can be seen that there must be some restrictions due to hardware reasons when two communication protocols are used:

If the Communication Driver is alone using both serial communication ports - the PLC and the PC/Printer port - it cannot be used in multi-protocol configurations.

If two Communication Drivers are both serial, there will be no ports left to connect the serial UniNET network. (You can still use the Ethernet-based UniNET, of course.)

Since only one communication module can be plugged into the Panel, a combination of two Communication Drivers, each requiring such a module, cannot be supported.

As the Ethernet protocol is also supported by a communication module, a combination of one Ethernet-based Communication Driver and a Driver requiring any other communication module cannot be supported either.

Note: Two Ethernet-based Communication Drivers can normally be used simultaneously because they will both communicate through the same Ethernet communication module. Ethernet-based UniNET can also be used in addition to one or two Ethernet-based Communication Drivers.

Information is provided on the following topics:

Enabling Multiple-Protocol Configuration

Controllers Setup

Placing Fields on a Page

Downloading Uploading and Getting Panel Resources

Configuring UniNET Networks

## **7.2.2 Enabling Multiple-Protocol Configuration**

After choosing the "Configure Controller..." menu option in the Designer software, the Configure Controllers Dialog Box will pop up. It is used for selecting the communication drivers both in single protocol and multi-protocol configurations.

To select the Second Driver check the "Enable Double Protocol" check box. A new text box and a button are shown. After selecting particular Driver from the list below, you simply click at the adequate "Set" button to set the First or the Second Driver. (To go back to the single protocol configuration case, simply uncheck the "Enable Double Protocol" check box.)

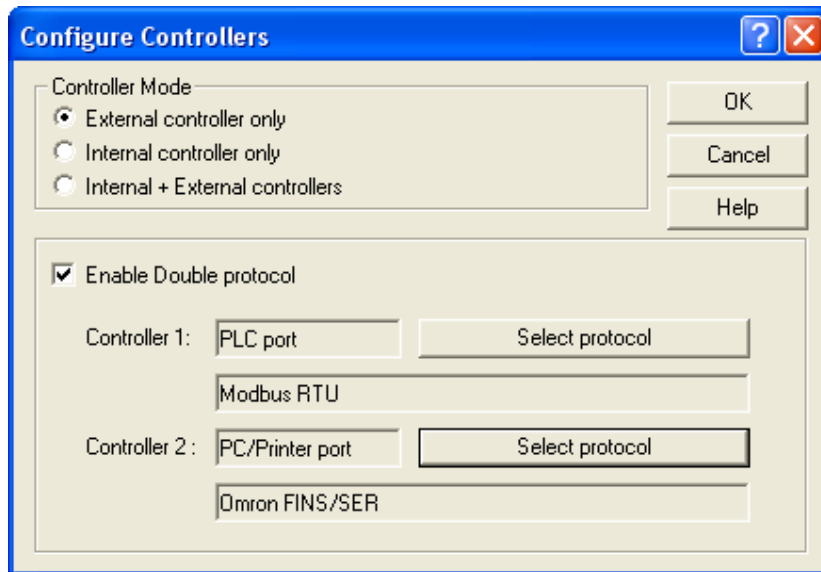

It can be noted that once the “Enable Double Protocol” check box is checked, the contents of the list box showing all available drivers may be somewhat changed. After checking the check box, only drivers that have the multi-protocol capability enabled are shown in the list box. Thus, if there are such drivers installed that do not allow combining with other drivers into multi-protocol configurations, these will be excluded from the list and the list will be shortened. After un-checking the check box, all the drivers will be re-displayed in the list box.

By pressing the “OK” button the configuration is accepted. The Designer will issue a warning if an illegal combination is chosen and will not close the Dialog Box until an allowed configuration is selected.

After the multi-protocol application is successfully configured, the status line of the Designer main window shows the “Double protocol” string in the place where the driver name string is displayed in the single protocol case. (Limited space does not allow displaying both names.)

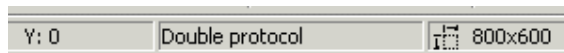

If at least one of the drivers is a serial driver, the decision which Driver will be set as the First, and which one the Second is not completely unimportant.

The First Driver will use the PLC port, and the Second Driver will use the PC/Printer port. So if one of drivers is using the current loop, it will be necessary to make it the First Driver and so ensure it uses the PLC port, because the current loop capability is only implemented on this serial port. Also, as the PC/Printer and the PLC port connectors are of different genders, selecting the First and the Second Driver smartly can make cabling easier and less expensive.

The Configure Controller dialog box shows the port assignment resulting from the configuration.

### 7.2.3 Controllers Setup

The "Configure Controller..." menu option always displays the Configure Controllers Dialog Box.

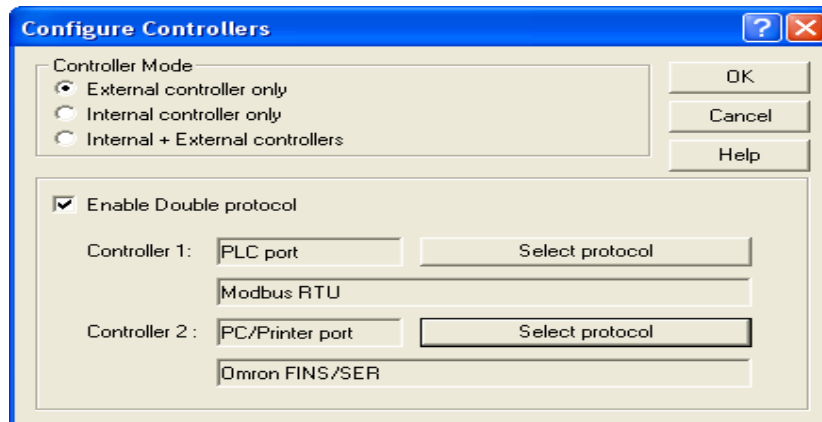

When pressing the "..." button associated to a given controller, the Designer will show a list of controllers, with the associated controller in pre-selected status.

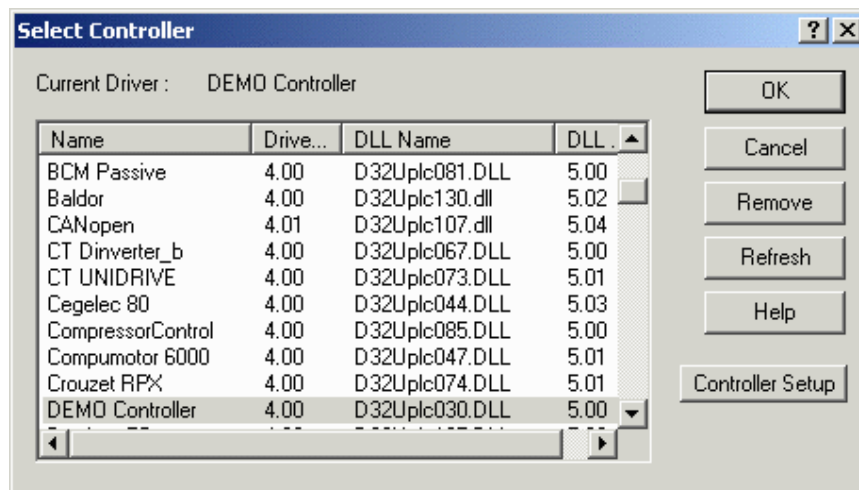

From this list it is possible to open the Controller Setup Dialog Box, by pressing the Controller Setup button.

It can be noted, that it is allowed to have PLC networks configured for both drivers (naturally, if both communication drivers are able of supporting PLC networks). Therefore, two independent PLC network branches can be connected to a single Panel.

### 7.2.4 Placing Fields on a Page

When the user in the Designer chooses to put a field onto a page, the "Field Properties" dialog box is displayed.



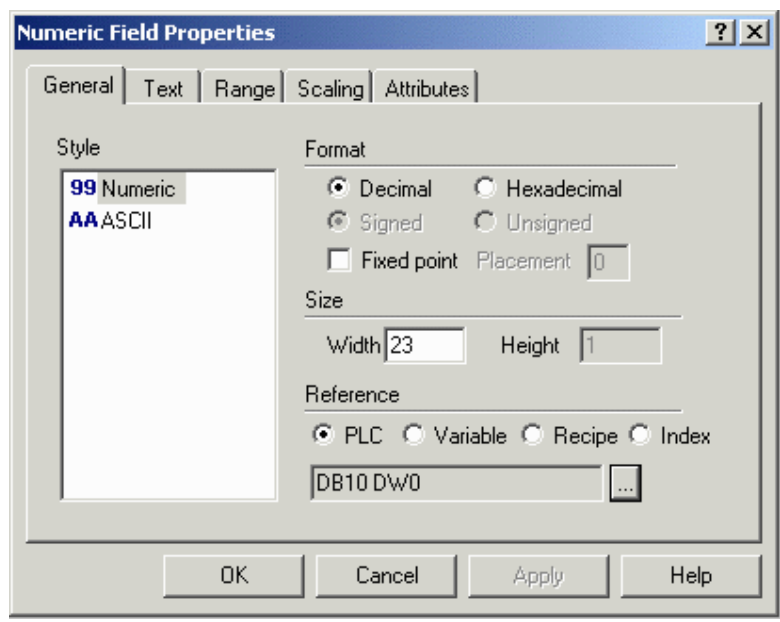

When selecting "PLC" in the "Reference Section" and pressing the "..." button, the "Data Field Properties" dialog box is displayed. In the "Network" tab the user can specify which controller is to be referred by the data field.

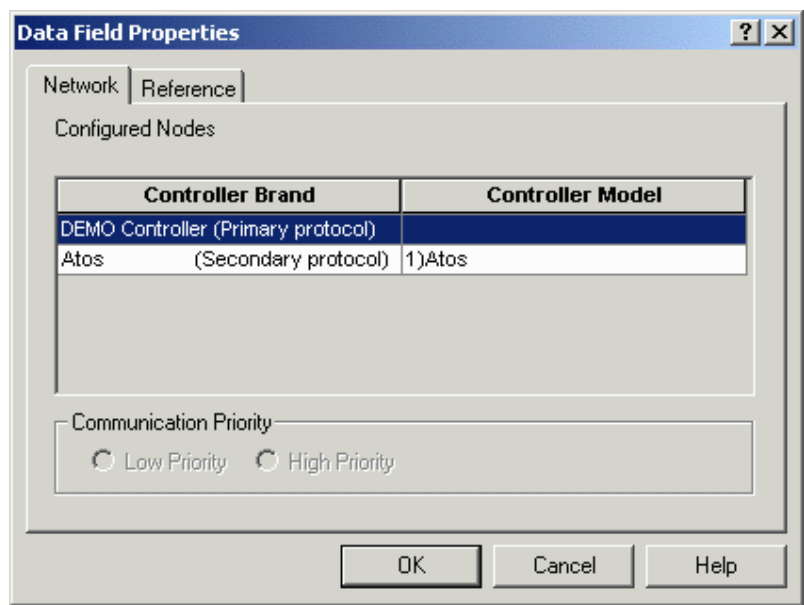

This offers the user a very flexible approach. It is possible to put fields from all controllers next to each other on a single UniOP page, irrespective of the communication protocol they are using. Moreover, it is possible to scale a value from one controller with a value from the other. It also enables you to keep parts of RDA and recipes in different controllers. The same is with alarm triggers. The best of all, you can program data transfers from two totally different types of controllers or controller networks.

### 7.2.5 Downloading Uploading and Getting Panel Resources

There is almost no difference between downloading and uploading single protocol projects and multi-protocol projects. Only, as can be expected, first downloads of multi-protocol projects will last longer because two drivers must be downloaded instead of one.

The “Controller type” section of the Panel Resources Dialog Box is now two lines wide. In the first line there will be the name of the First Driver, and in the second one the name of the Second Driver. In the case of single protocol configuration, the second line will be empty.

### 7.2.6 Configuring UniNET Networks

There is no major difference in configuring UniNET network for single protocol applications and for multi-protocol applications.

First two steps, choosing the network media and the network type, are the same. However, if one of the network types “Single Server, Multiple Clients” or “Multiple Server, Multiple Clients” is selected, it is worth noticing that all the UniOP network server nodes will inherit the current configuration of the project. In other words, if the project in which the network is being setup is currently configured for single protocol, all the UniOP node servers in the UniNET network will be configured to use only this protocol. If the project is configured for multi-protocol, all the UniOP node servers will again be configured to use both protocols.

If the “Mixed Multiple Servers, Multiple Clients” network type chosen, the Designer will pop up the “Network Configuration” Dialog Box. This is the way to configure the UniNET network completely freely. It is possible to configure UniOP nodes in different ways. Some UniOP nodes may stand for bare client network nodes having no controllers connected to them. Other nodes (server nodes) can be configured to communicate over one protocol (single-controller configuration) or two protocols (multi-protocol configuration), where any UniOP server be configured to support any allowed combination of drivers.

The “Network Configuration” Dialog Box looks as in the illustration below. (Minor differences are possible depending on the selected network type.)

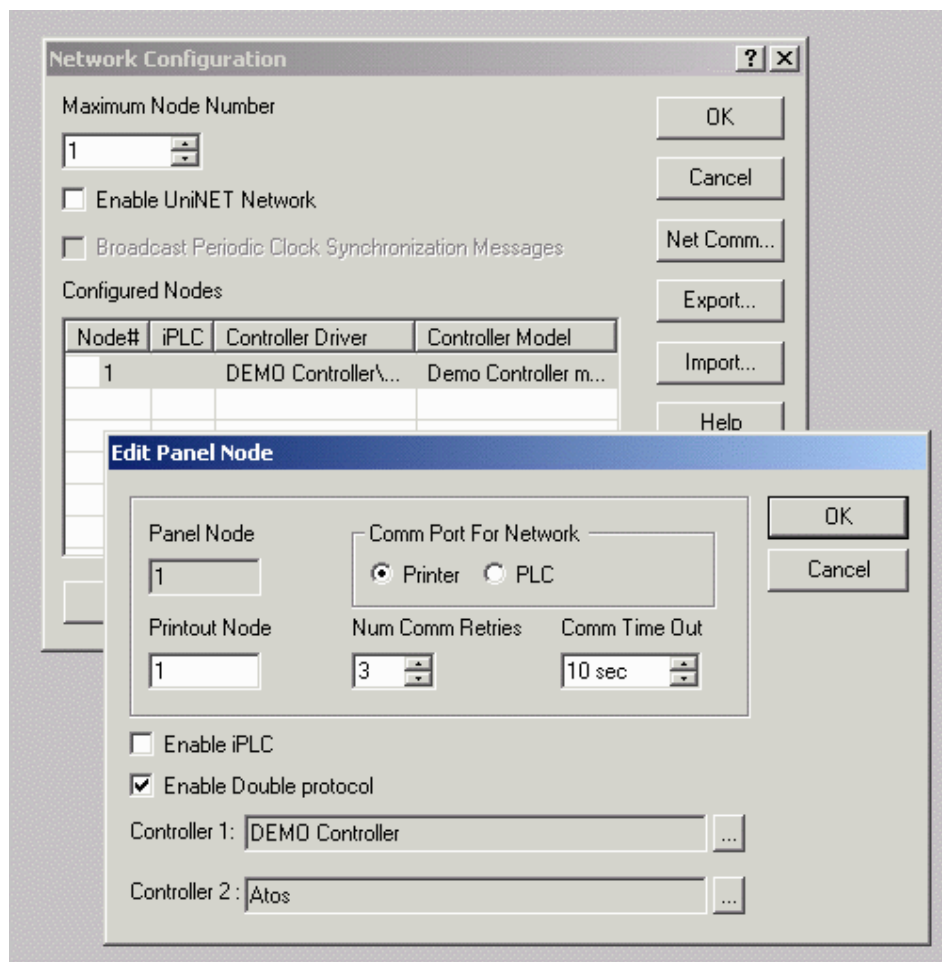

By selecting a node and requesting its properties (i.e. by pushing the "Properties") it is possible to have access to the Double Protocol configuration of that node.

## 7.3 Interlock Mailbox

### 7.3.1 Interlock Mailbox

The UniOP Interlock Mailbox is designed to allow the operator interface panel to interact with the controller's ladder logic program.

The Interlock Mailbox is simply a group of registers in the controller memory (from a minimum of 2 registers to a maximum of 20). The mailbox can be placed anywhere in the controller memory at an address you select. When the mailbox is enabled, the operator panel cyclically reads the contents of the mailbox from the controller.

The controller can command the UniOP panel to perform certain tasks by placing data in the memory area used by the mailbox. When the panel detects that the controller has written data in the mailbox, it interprets the data as a numeric code for a required command. If the panel recognizes the command, it immediately executes it. If the command requires a response from the panel, then the panel places the response back into the mailbox itself.

Note: The Interlock Mailbox offers a powerful way to control the operation of recipes from the controller.

In general, the Interlock MailBox works by writing a command into the Command/Response Word.

Available commands can be seen in the table of available mailbox commands. Depending upon the command, certain parameters may have to be entered. Once the parameters are entered, a code needs to be written to the Status Word. When the command written into the Command/Response Word is attempted/executed, a Response Word will be written into the Command/Response Word, indicating the status of the command.

If you have the mailbox set up to be cyclically read, this is all that needs to be done.

If bit C15 is active, then one additional step is necessary. Since this bit must be a logic high in order for the mailbox to be read, you need to write a value of 1 to this bit. Once it is "set", a "1" needs to be written to the Status Word to indicate a pending request in the mailbox.

Details of enabling the Interlock Mailbox, the structure of the mailbox, Interlock Mailbox commands, and mailbox programming are provided.

## 7.3.2 Enabling the Internet Mailbox

## 7.3.3 Enabling the Internet Mailbox

To enable the Interlock Mailbox, select the Interlock Mailbox tab from the Panel Controller Interface dialog box under the Project menu.

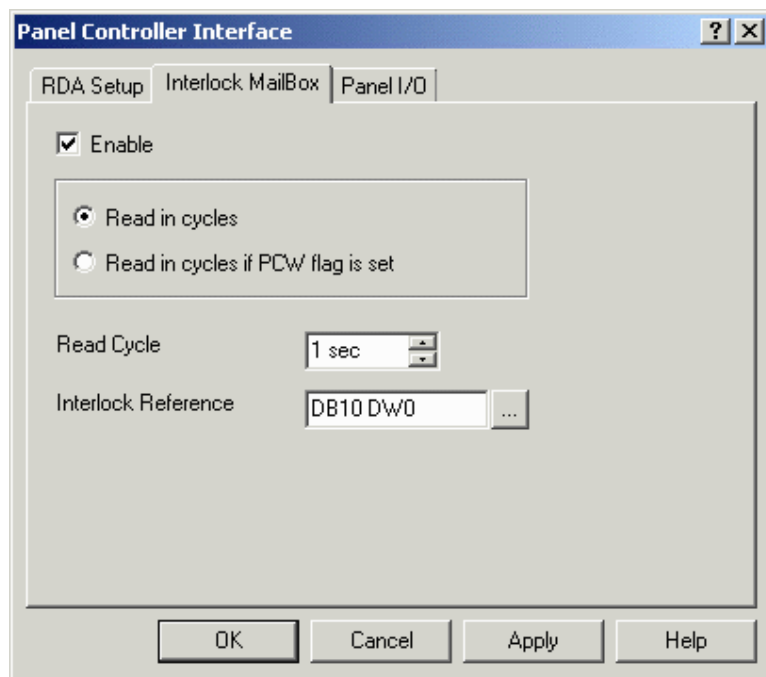

The mailbox is disabled by default. To enable it, simply mark the checkbox entitled Enable.

Details about the read cycle modes and the interlock reference are provided.

### 7.3.4 Read Cycle

The Read Cycle time under Project - Panel Controller Interface - Interlock Mailbox specifies how frequently the operator panel will read the data in the mailbox to check to see if it contains a new command.

The faster the mailbox Read Cycle, the faster the panel will respond to commands from the controller.

However, the update of the variables shown on the display will be slower.

### 7.3.5 Interlock Reference

The Interlock Reference is the address of the first Mailbox register in the controller memory. The address can be entered directly as a string or via the Data Field Properties dialog box displayed by clicking on the "..." button.

A memory map of the Mailbox in the controller memory is shown below. The Status Word and the Command/Response Word are always required for the Mailbox. Parameter 0 - Parameter 17 Words are only used if required by the particular mailbox command.

Offset	Item
0	Status Word
1	Command/Response Word
2	Parameter 0
3	Parameter 1
...	...
19	Parameter 17

Note: When entering the starting address, care must be taken to ensure that the controller memory used by the Mailbox does not overlap with the memory areas reserved for other panel functions such as alarms, I/O update, keyboard update, etc.

### 7.3.6 Structure of the Mailbox

### 7.3.7 Structure of the Mailbox

The controller can issue different commands depending upon the values written to the mailbox.

Some commands require parameters (which have a binary numeric format) to be included with the command, while other commands require the panel to respond with data.

The structure of the mailbox in the controller memory is shown below. The Status Word and the Command/Response Word are always required for the mailbox. Parameter 0 - Parameter 17 Words are only used if required by the particular mailbox command.

You can determine the controller memory addresses of all the data elements in the mailbox by using the starting address of the mailbox area (set under Project - Panel Controller Interface - Interlock Mailbox) and the memory map shown below.

The Interlock Reference is the address of the first Mailbox register in the controller memory. The address can be entered directly as a string or via the Data Field Properties dialog box displayed by clicking on the "... " button.

Offset	Item
0	Status Word
1	Command/Response Word
2	Parameter 0
3	Parameter 1
...	...
19	Parameter 17

Note: When entering the starting address, care must be taken to ensure that the controller memory used by the Mailbox does not overlap with the memory areas reserved for other panel functions such as alarms, I/O update, keyboard update, etc.

### 7.3.8 Status Word

The Status Word is the main handshaking register of the mailbox. Both the controller and the panel can write to this register. The status word contains a binary number, the meaning of which is described below.

Code	Status	Written by
0	No request, Mailbox is available	Controller
1	Pending request	Controller
2	Mailbox busy	Panel
3	Error code: Illegal command	Panel
4	Command completed	Panel
5	Panel restart	Panel

### 7.3.9 Command Response Word

The controller specifies which mailbox command it wants to execute by placing the command code of the desired command in the Command/Response Word.

The available mailbox commands and their command codes are given.

The UniOP panel writes a binary value to the Command/Response Word when it has executed the command requested by the controller to indicate the result of the operation.

### 7.3.10 Parameters

The Parameter Words are used only when required by a specific command.

Some commands do not require any parameters at all. The Interlock Mailbox Commands section describes how to use Parameter Words and which are required for each Command Word.

### 7.3.11 Interlock Mailbox Commands

### 7.3.12 Interlock Mailbox Commands

Command	Description
1	Recipe Status
2	Start Recipe Download
3	Start Recipe Upload
4	Set Parameter Set Number
5	Get Parameter Set Number
6	Get Recipe Transfer Priority
7	Set Recipe Transfer Priority
17	Request Data Entry Mode
21	Request Masked Data Entry Mode
22	Request masked Data entry Mode (with keyboard index)
33	Password Status
34	Password Logout
49	Start Controller to Controller Transfer With No Confirmation
50	Start Controller to Controller Transfer With Confirmation
81	Set the Real Time Clock (RTC)
97	Clear Event List
113	Start Report Printout
114	Stop Report Printout
115	Start Alarm List Printout
116	Start Event List Printout
129	Get Current Language
130	Set Current Language
145	Start Screen Saver
146	Stop Screen Saver
147	Enable Screen Saver Function in Alarm Mode
148	Disable Screen Saver Function in Alarm Mode

### 7.3.13 Recipe Status

The controller can use this command to request information on the status of the recipes in the panel.

Command code: 1

No parameters are required by this command. The panel will respond with a code in the Command/Response Word. The possible codes are listed below.

Code	Description
0	OK, Recipes contain valid data
1	Error: Recipes contain default data as defined in the project file
2	Error: There are no Recipes defined
3	Error: Error in project file

### 7.3.14 Start Recipe Download

The controller can use this command to start a recipe download from the panel memory to the controller memory.

Command code: 2

Two parameters are required by this command:

Parameter 0	Page number of required recipe (1 - max. page number in project file)
Parameter 1	Parameter set number(1 - max. number of pre-defined parameter sets)

The panel will respond back to the Command/Response Word with one of the codes listed below after performing the operation.

Note: A recipe transfer may take several seconds, depending mainly on the number of bytes that have to be transferred.

Code	Description
0	OK, Transfer completed successfully
1	Error: Recipes contain default data
2	Error: There are no Recipes defined
3	Error: Error in project file
4	Error: Illegal Page number has been requested
5	Error: Illegal number of parameter set has been requested
6	Error: The requested parameter set is locked (that is, it is being used by the operator panel for a data entry operation)
7	Error: A communication error occurred during the transfer

### 7.3.15 Start Recipe Upload

The controller can use this command to start a recipe upload from the controller memory to the panel memory.

Command code: 3

Two parameters are required by this command:



Parameter 0	Page number of required recipe (1 - max. page number in project file)
Parameter 1	Parameter set number(1 - max. number of pre-defined parameter sets)

After performing the operation, the panel will respond back to the Command/Response Word with one of the codes listed below.

Note: A recipe transfer may take several seconds, depending mainly on the number of bytes that have to be transferred.

Code	Description
0	OK, Transfer completed successfully
2	Error: There are no Recipes defined
3	Error: Error in project file
4	Error: Illegal Page number has been requested
5	Error: Illegal number of parameter set has been requested
6	Error: The requested parameter set is locked (that is, it is being used by the operator panel for a data entry operation)
7	Error: A communication error occurred during the transfer

### 7.3.16 Set Parameter Set Number

The controller can use this command to select a given recipe parameter set.

Command code: 4

Two parameters are required by this command:

Parameter 0	Page Number(1 - max. number of pages in the project file)
Parameter 1	Parameter Set Number(1 - max. number of pre-defined parameter sets)

After performing the operation, the panel will respond back to the Command/Response Word with one of the codes listed below.

Code	Description
0	OK
2	Error: Recipes not defined in project file
3	Error: Error in project file
4	Error: Illegal page number requested
5	Error: Illegal record number requested
6	Error: Requested record locked

### 7.3.17 Get Parameter Set Number

The controller can use this command to get the current recipe parameter set number.

Command code: 5

Only one parameter is required by this command:

Parameter 0	Page Number(1 - max. number of pages in the project file)
-------------	---

After performing the operation, the panel will respond back to the Command/Response Word with one of the codes listed below.

Code	Description
0	OK
2	Error: Recipes not defined in project file
3	Error: Error in project file
4	Error: Illegal page number requested

### 7.3.18 Get Recipe Transfer Priority

The controller can use this command to get the current recipe transfer priority level.

Command code: 6

This command requires no parameters.

After performing the operation, the panel will respond back to the Command/Response Word with one of the codes listed below.

Code	Description
0	Normal
1	Highest
2	Error: Recipes not defined in project file

### 7.3.19 Set Recipe Transfer Priority

The controller can use this command to set the current recipe transfer priority level.

Command code: 7

Only one parameter is required by this command:

Parameter 0	Priority Level (0=Normal, 1=Highest)
-------------	--------------------------------------

After performing the operation, the panel will respond back to the Command/Response Word with one of the codes listed below.

Code	Description
0	OK

2	Error: Recipes not defined in project file
3	Error: Illegal priority setting requested

### 7.3.20 Request Data Entry Mode

The controller can use this command to switch the operator panel to Data Entry Mode.

Command code: 17

Two parameters are required by this command:

Parameter 0	Index Number of required Page(1 - max. page number in project file)
Parameter 1	Index Number of required Data Field (1 - max. number of data fields in the page)

After performing the operation, the panel will respond back to the Command/Response Word with one of the codes listed below.

Code	Description
0	OK
1	Error: Illegal page number has been requested
2	Error: Illegal field number has been requested
3	Error: Panel is not ready for Data Entry Mode

### 7.3.21 Request Masked Data Entry Mode

The controller can use this command to switch the operator panel to Data Entry Mode using masked data entry. This is similar as Request Data Entry command (Paragraph 1, CommandWord 0x0011), but Numeric Keypad is shown if touch panel is used.

Command code: 21

Two parameters are required by this command:

Parameter 0	Index Number of required Page(1 - max. page number in project file)
Parameter 1	Index Number of required Data Field (1 - max. number of data fields in the page)
Parameter 2	Flags: B0: masked data entry B1-B15: reserved (0)

After performing the operation, the panel will respond back to the Command/Response Word with one of the codes listed below.

Code	Description
------	-------------

0	OK
1	Error: Illegal page number has been requested
2	Error: Illegal field number has been requested
3	Error: Panel is not ready for Data Entry Mode
4	Error: Panel is not a touch
5	Error: Illegal/unsupported/reserved flags are set

### 7.3.22 Password Status

The controller can use this command to request information about the current password status.

Command code: 33

The command requires no parameters.

After performing the operation, the panel will respond back to the Command/Response Word with one of the codes listed below.

Code	Description
0	No passwords are defined in the project file
1	No valid password has been entered
2	A valid password has been entered
3	The system default password (0007) has been entered

If Code 2 is returned, the Parameter Words will contain additional information as follows:

Parameter 0	Current password level
Parameter 1	First character (ASCII coded) of the current password
Parameter 2	Second character (ASCII coded) of the current password
Parameter 3	Third character (ASCII coded) of the current password
Parameter 4	Fourth character (ASCII coded) of the current password

### 7.3.23 Start Controller to Controller Transfer with No Confirmation

This feature allows the user to transfer data in two different manners:

Between two controllers. In this case, the controllers can be connected by a controller network or with the UniNET network.

Between two registers located within the same controller.

Note: Deleting a job changes the position of subsequent jobs (if job 2 is deleted, then job 3 will become job 2).

We will call one complete data transfer a "job". When the controller requests a job to be executed, the panel responds immediately back to the controller and executes the job as

soon as possible. Therefore, the controller does not know when, or if, the requested job will be executed.

To set up a transfer, select Project - Panel Controller Interface - Data Transfer. The Job No. field is used to select between the different jobs. Click on the Source Reference button to specify the register to be read.

The fields will be slightly different depending on the controller that is being used. Use the fields to specify the type of data, format, and address of the register that is to be read. Once this information is entered, press OK to return to the Panel Controller Interface dialog box. Enter the number of words to be transferred in the appropriate box. Click on the Destination button brings up a dialog box in which you can enter the address to which the data is to be written.

If the Job Execution Mode is set to In Cycles, the panel will automatically transfer the data on each cycle. The cycle period can be set between 1 second and 127 seconds. Remember that the faster the cycles, the faster the panel will transfer data, but this will slow down the rest of the system. If the Job Execution Mode is set to On Request, the controller must send a request to the Interlock Mailbox before the data will be transferred. After completely setting up the dialog box, click on OK. Now select the Interlock Mailbox tab from Project - Panel Controller Interface. Set up the mailbox as described within the section entitled Enabling the Interlock Mailbox. When the controller sends a request to the mailbox, the mailbox will read the command word and the parameter. The panel will then send a response word back to the controller and execute the command.

Command code: 49

This command requires only one parameter:

Parameter 0	Job Number (1-255)
-------------	--------------------

After performing the operation, the panel will respond back to the Command/Response Word with one of the codes listed below.

Code	Description
0	OK
1	Error: Controller to Controller not defined at all
2	Error: Illegal job number
3	Error: Queue is full

### 7.3.24 Start Controller to Controller Transfer with Confirmation

This command is set up in the same manner as the command Start Controller to Controller Transfer With No Confirmation.

Command code: 50

This command requires only one parameter:

Parameter 0	Job Number (1-255)
-------------	--------------------

After performing the operation, the panel will respond back to the Command/Response Word with one of the codes listed below.

Code	Description
0	OK
1	Error: Controller to Controller not defined at all
2	Error: Illegal job number
3	Error: Not used
4	Error: Communication error while reading source data
5	Error: Communication error while writing destination data

### 7.3.25 Set RTC (Real Time Clock)

This command enables the controller to set the Real Time Clock (RTC) located within the panel.

Command code: 81

This command requires six parameters:

Parameter 0	Day (1-31)
Parameter 1	Month (1-12)
Parameter 2	Year (94...99, 00....)
Parameter 3	Hour (0-23)
Parameter 4	Minute (0-59)
Parameter 5	Second (0-59)

After performing the operation, the panel will respond back to the Command/Response Word with one of the codes listed below.

Code	Description
0	OK
1	Error: RTC error
2	Error: Requested setting out of range

### 7.3.26 Clear Event List from Controller Mailbox

The controller can use this command to request that the UniOP panel clear its event list.

Command code: 97

The command requires no parameters.

After performing the operation, the panel will respond back to the Command/Response Word with a 0, indicating that the event list has been cleared.

### 7.3.27 Start Report Printout

This command is used to start a report printout.

Command code: 113

This command requires only one parameter:

Parameter 0	Report Number
-------------	---------------

After performing the operation, the panel will respond back to the Command/Response Word with one of the codes listed below.

Code	Description
0	OK
1	Error: Printer process already active (if START command is issued more than once) Error: Printer process already inactive (if CANCEL command is issued more than once)
2	Error: Illegal report number
3	Error: Activation queue is full

### 7.3.28 Stop Report Printout

This command is used to stop a report printout.

Command code: 114

This command requires no parameters.

After performing the operation, the panel will respond back to the Command/Response Word with one of the codes listed below.

Code	Description
0	OK
1	Error: Printer process already inactive

### 7.3.29 Get Current Language

The controller can use this command to get the number of the currently active language from the panel.

Command code: 129

This command requires no parameters.

After performing the operation the panel will respond back to the Command/Response Word with one of the codes listed below.

Code	Description
0	OK
1	Error, the project is not multilanguage.

If Code 0 is returned, the Parameter Word 0 will contain the number of the active language.

### 7.3.30 Set Current Language

The controller can use this command to change the language in the operator panel.

Command code: 130

Parameter 0	Language number
-------------	-----------------

After performing the operation the panel will respond back to the Command/Response Word with one of the codes listed below.

Code	Description
0	OK
1	Error, the project is not multilanguage.
2	Error, illegal language number requested

### 7.3.31 Start Screen Saver

It is possible to activate the screen saver from the controller using this command.

Command code: 145

No parameters are required by this command. The panel will respond with a code in the Command/Response Word. The possible codes are listed below.

Code	Description
0	OK
1	Error: screen saver not enabled in the project

### 7.3.32 Stop Screen Saver

It is possible to deactivate the screen saver from the controller using this command.

Command code: 146

No parameters are required by this command. The panel will respond with a code in the Command/Response Word. The possible codes are listed below.

Code	Description
0	OK



1	Error: screen saver not enabled in the project
---	--

### 7.3.33 Enable Screen Saver Function in Alarm Mode

The controller can use this command to enable the default behaviour of the screen saver in Alarm Mode.

If UniOP is in Alarm Mode and the time for screen saver activation has elapsed, the screen saver function will start. Simply touch a key to stop screen saver activity. This command code can be used following command 148 to go back to the default setting.

Command code: 147

No parameters are required by this command. The panel will respond with a code in the Command/Response Word. The possible codes are listed below.

Code	Description
0	OK

### 7.3.34 Disable Screen Saver Function in Alarm Mode

It is possible to automatically reactivate the screen whenever an alarm has to be displayed.

The controller can use this command to disable the screen saver function when UniOP is in Alarm Mode.

If UniOP panel has the screen saver activated because of the elapsed programmed time and an alarm is activated, the UniOP panel will automatically turn off the screen saver and display the alarm page. The alarm page will be displayed until at least one alarm condition is active.

Use command code 147 to go back to the default behavior.

Command code: 148

No parameters are required by this command. The panel will respond with a code in the Command/Response Word. The possible codes are listed below.

Code	Description
0	OK

### 7.3.35 Mailbox Programming

To use the mailbox successfully, the panel and the controller must interact tightly.

The interaction between the panel and the controller can be thought of as a short conversation between two people.

The first person (the controller) tries to start a conversation with the second person (the UniOP panel) on a particular topic (the mailbox command code). After the first person has introduced himself and the topic of the conversation, the second person decides whether he feels competent enough to join in. If the second person decides not to join in the conversation, he politely informs the first person that he feels he does not know enough about that particular topic to make an informed comment and waits for a change in the topic of the conversation. If the second person does decide to enter into the conversation, he ponders the topic and then expresses his well-considered opinion.

The vital ingredient in a successful conversation is that nobody is interrupted while they are talking.

The flow chart below describes the program sequences that must be executed in parallel by both the UniOP panel and the controller ladder logic program to ensure a successful Mailbox session.

The following important notes should be kept in mind:

At system start-up, the UniOP panel writes the special Status Code Panel Restart to inform the controller that the panel itself has been reset.

Both the panel and the controller can write to the Status Word and the Command/Response Word; however, they must not write at the same time to the same memory location. Proper operation of the mailbox is ensured if the sequence described in the figure is followed.

The controller program must always wait for the completion of the current Mailbox session before attempting to start a new one.

The controller program should always check the status returned by the UniOP panel on completion of a session.

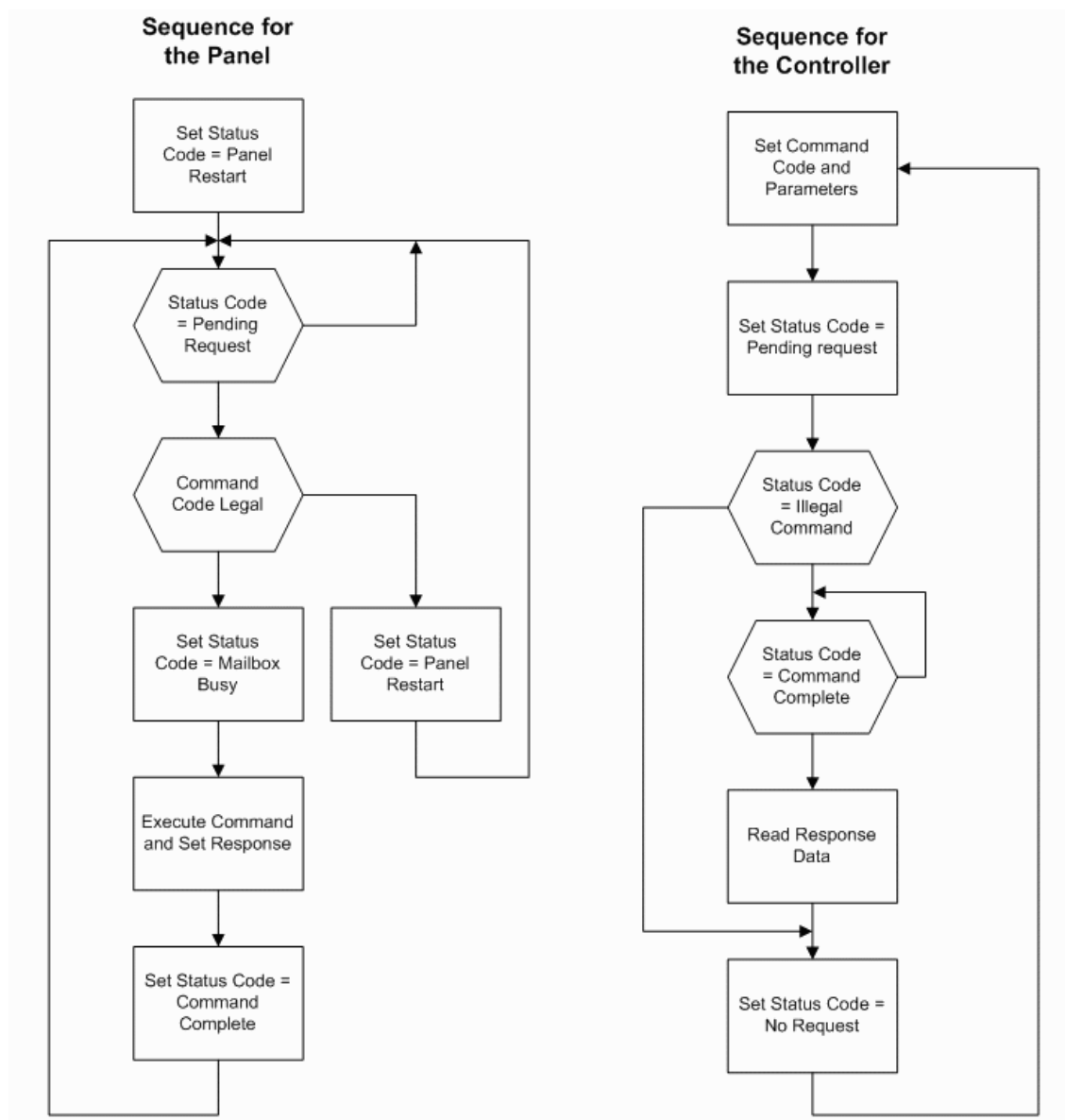

## 7.4 Networks

### 7.4.1 UniNET Networks

The UniNET network is a feature of the operator panels that enables them to be connected together and to communicate with each other.

This offers the ability to display on one panel either the data from the controller attached to the panel itself, or data from other controllers attached to other panels on the network.

First the General Characteristics are introduced. Then the various, possible, Network Configurations and the two supported Network Types. Later detailed instructions on

Connecting Panels to the Network and on the Network Setup are given. Finally a Network Example is given.

### **7.4.2 General Characteristics**

### **7.4.3 General Charatceristics**

This section presents the concepts of Clients and Servers and the common Technical Data of all Uninet Networks. The reader should be comfortable with the Graphic Symbols used throughout the chapter.

### **7.4.4 Clients and Servers**

The operator panels attached to the UniNET Network can be classified in two categories, depending on the type of communication that they can support once they are placed in the network: Server type panels and Client type panels.

A panel is a Server when it is connected directly to a controller. It makes available to other panels in the network the data in the controller. It makes available to other panels in the network the data in the controller to which its attached.

A panel is a Client when it requests data from a controller attached to a Server on the network.

Note: Some UniOP panel have only one serial connection (they do not have a PC/Printer port). So you can attach the panel via this serial connection either to a PLC or, as a client, to a UniNET Network. In case the panel has an optional communication module and is connected to the PLC via the Aux port of this communication module, then the panel can use its serial connection to become a UniNET Network server.

A panel can be, in certain cases, both a Server and a Client. This means that the panel both satisfies the requests from other panels that require access to the data in the controller to which it is attached, and also requests data from the controllers attached to other Servers.

The UniNET Networks supports two types of connectivity:

RS485 Connectivity

Ethernet Connectivity

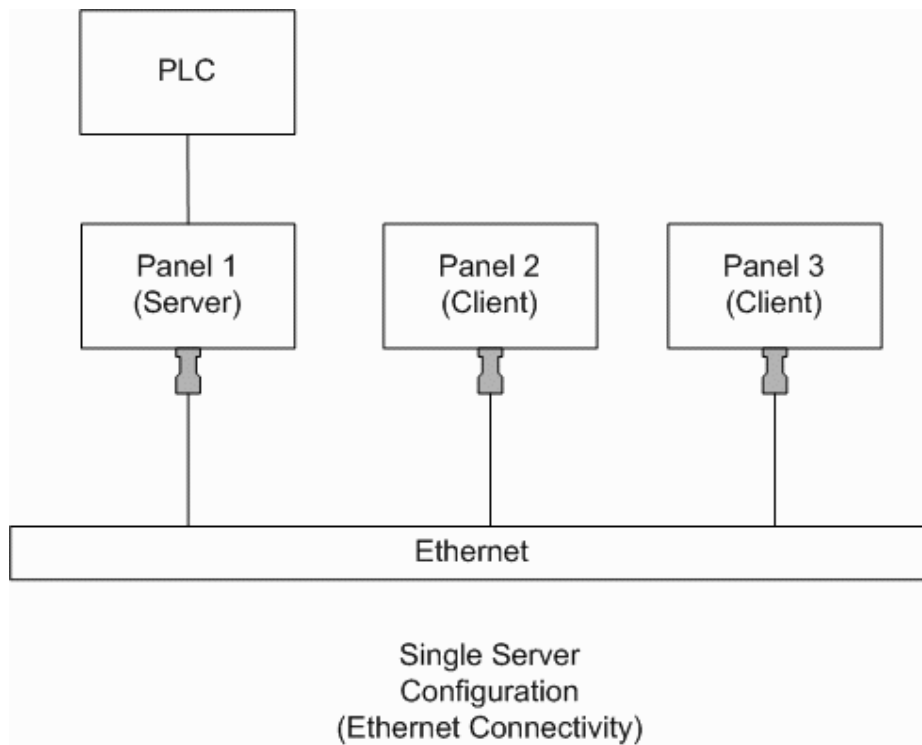
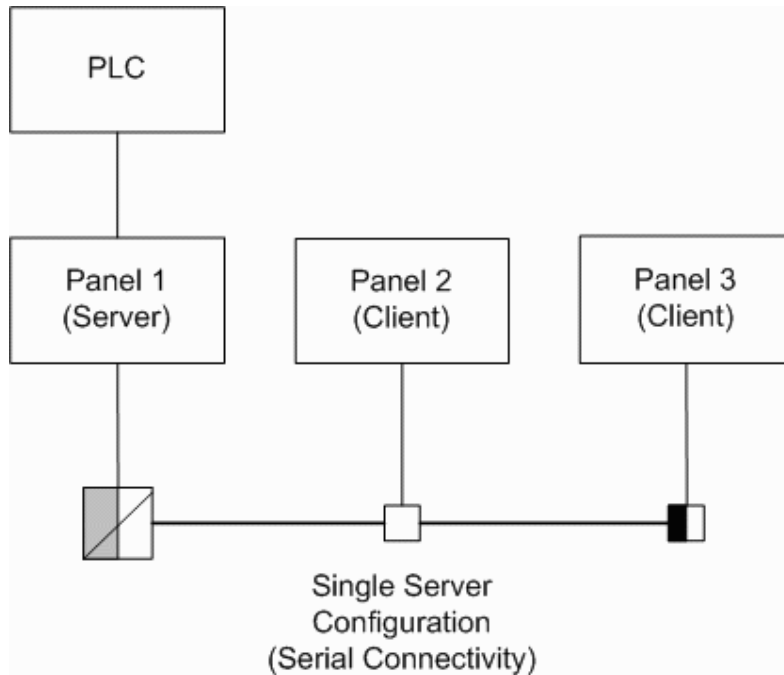

The Single Server Configuration, using either the Serial Connectivity or the Ethernet Connectivity, allows many panels to access data from a single controller via a panel acting as the single Server. The client panels can perform all of the normal operations as if they were connected directly to the controller, including: displaying of variables, modifying of variables, handling of Recipes, handling of the Reserved Data Area, etc.

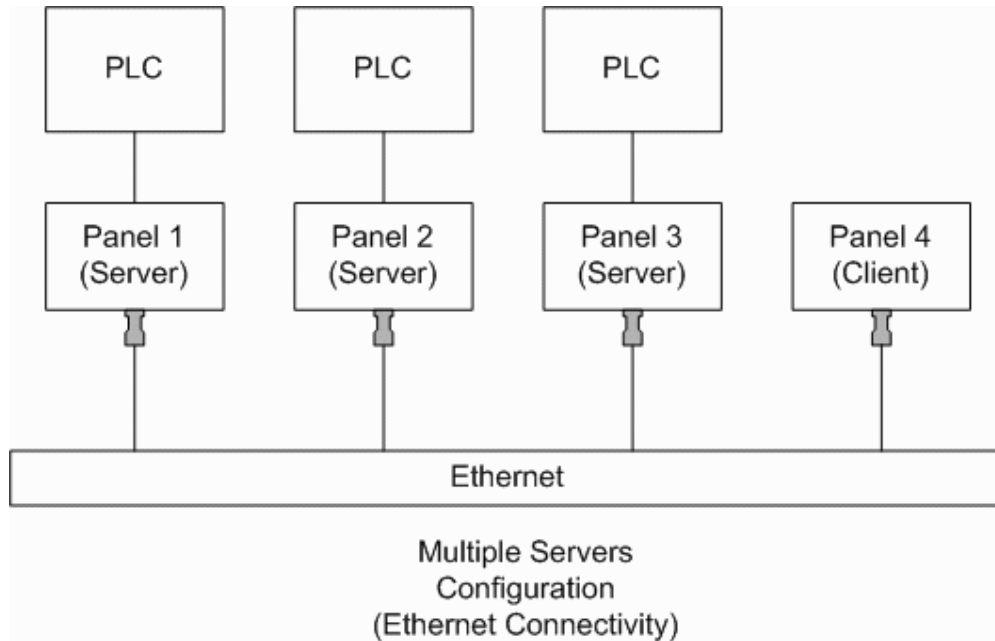
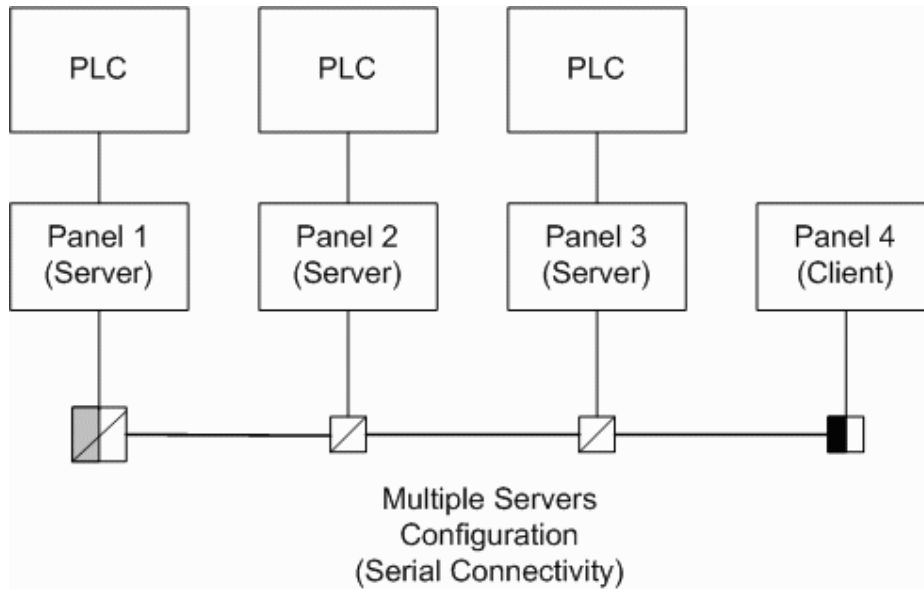

In the Multiple Servers Configuration, which may use Serial or Ethernet Connectivity, many controllers are accessed. The panels that are connected to a controller can function both as Servers and Clients. Therefore, they can read data from the controller to which they are directly attached and also from the controllers attached to other Servers. The Client panel can also read data from the controllers attached to the Servers. In this way, every single panel in the network has access to every single controller attached to the Servers in the network.

Note: in the Serial Connectivity an external RS-232 to RS-485 converter is required for each panel used as a Server. This is because Servers must be connected to the network using their PC/Printer port which, in the current hardware version, only has an RS-232 interface. The Client panels do not need an external converter to be attached to the UniNET network because they can be attached to the network using their PLC port which has an RS-485 interface as well as an RS-232 interface.

The TSI01 Bus Terminal and Converter provides additional optical isolation between the panel and the UniNET network. If you are using a Client panel attached to the network through a simple TSI02 Bus Terminal, there is no optical isolation. Optical isolation is recommended whenever panels are to be operated in a noisy environment or powered by different power sources. A completely optically isolated network can be obtained using a TSI01 Bus Terminal and Converter for each panel attached to the network.

Note: The network configuration shown in the above figure works even if the controllers are of different model types or if they are of different manufacturer brands. Designer allows the user to specify the addresses of the data items added to the project file using controller-specific addressing.

It is also possible to transfer data from one controller to another using the 'Data Transfer' feature supported by the operator panels. The transfer of data can be performed even if the controllers are of different manufacturer brands. The panels act as bridges connecting different controller worlds.

#### 7.4.5 UniNET Technical Data

The UniNET network has been designed to pass information between operator interface panels operating on the plant floor.

The UniNET network features are the following:

interconnection of up to 32 operator panels

multi-master capability

token-passing capability

All operator panels connected to the network may initiate a message transfer. The network protocol uses a token passing algorithm to determine which initiator has the right to transmit. A node holding the token is allowed only one transmission each time it receives the token. After a node sends one message packet, it attempts to give the token to its successor by sending a "token pass" message. If no network activity occurs, the initiator will attempt to find a new successor.

One of the main benefits of the token passing method is that every station on the network gets the chance to communicate, even in conditions of heavy communication load.

The maximum node address that the initiator will search before wrapping to zero is the value of the configurable parameter Maximum Node Number.







The main technical features of the UniNET Network are shown in the table below:

Characteristic	Serial Connectivity	Ethernet Connectivity
Maximum speed	19200 baud	10 Mbps
Physical interface	RS-485 Half Duplex	as per 10BaseT
Connection cable	Shielded twisted pair	Standard RJ45 Cable
Maximum length	1200 m	as per 10BaseT

Access control / protocol	Token Passing	UDP/IP
Maximum number of stations	32	32

### 7.4.6 Graphical Symbols

The following symbols are used in this chapter.

	Bus Terminal and RS-232 to RS-485 converter without termination resistor
	Bus Terminal and RS-232 to RS-485 converter with termination resistor
	Bus terminal without termination resistor
	Bus terminal with termination resistor
	10BaseT Ethernet Adapter
	Network cable

### 7.4.7 Network Configurations

### 7.4.8 Network Configurations

You may choose between three network configurations:

Single Server, Multiple Clients

Multiple Servers, Multiple Clients (same controller types)

Mixed Multiple Servers, Multiple Clients (different controller types)



## 7.4.9 Single Server Multiple Clients

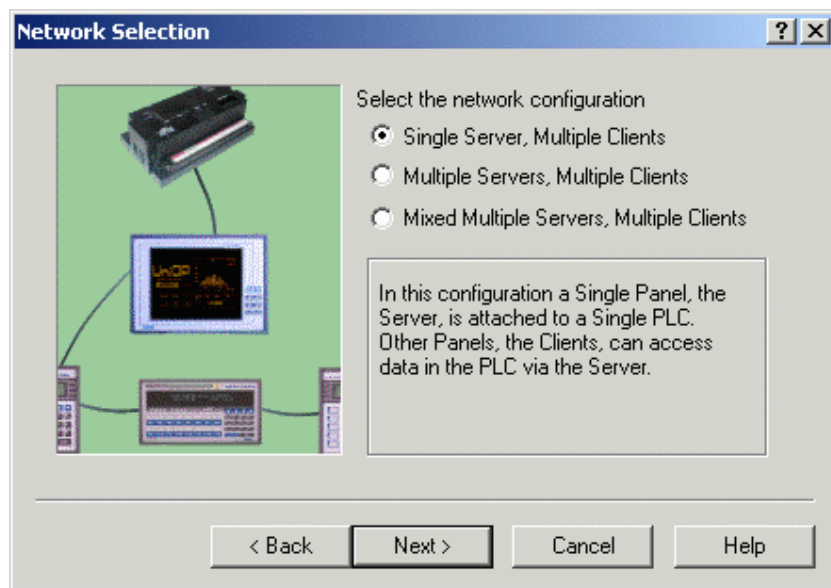

This network type consists of a single panel that is attached to a controller (the server) and one or more panels that are not attached to any controller (the clients). In this type of network, all of the clients and the server can read and write data to and from the single controller (attached to the single server).

You will be prompted to enter the number of clients. The network is automatically configured based on the default settings for the type of network. In general, these default settings should be sufficient for most needs. However, if it is necessary to modify these default settings, you may do so by clicking the Configure button to access the Network Configuration dialog box.

## 7.4.10 Multiple Servers Multiple Clients

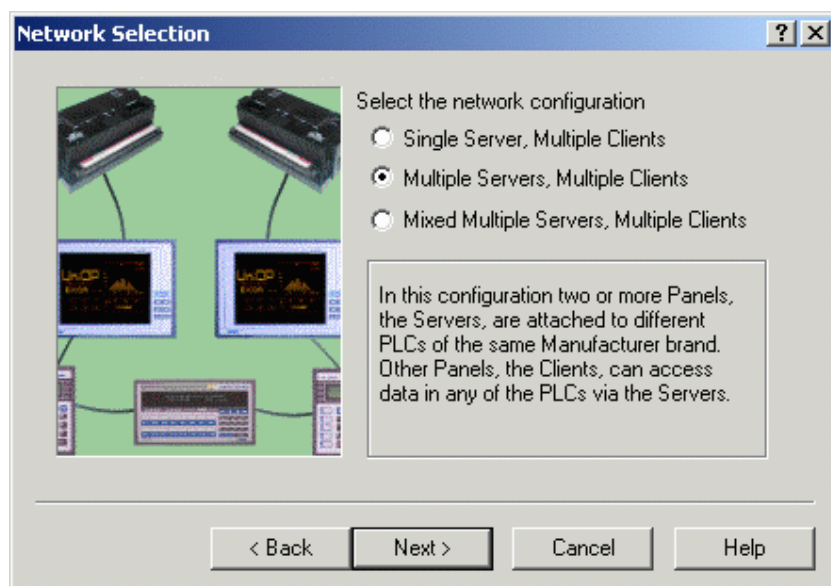

This network type consists of several panels that are attached to controllers of the same manufacturer brand (the servers) and several panels that are not attached to a controller (the clients). In this type of network, all of the clients and all of the servers can read and write data from and to every controller that are attached to a server in the network. You are prompted for the number of clients and servers.

The network is automatically configured based on the default settings for the type of network. In general, these default settings should be sufficient for most needs. However, if it is necessary to modify these default settings, you may do so by clicking the Configure button to access the Network Configuration dialog box.

#### 7.4.11 Mixed Multiple Servers Multiple Clients

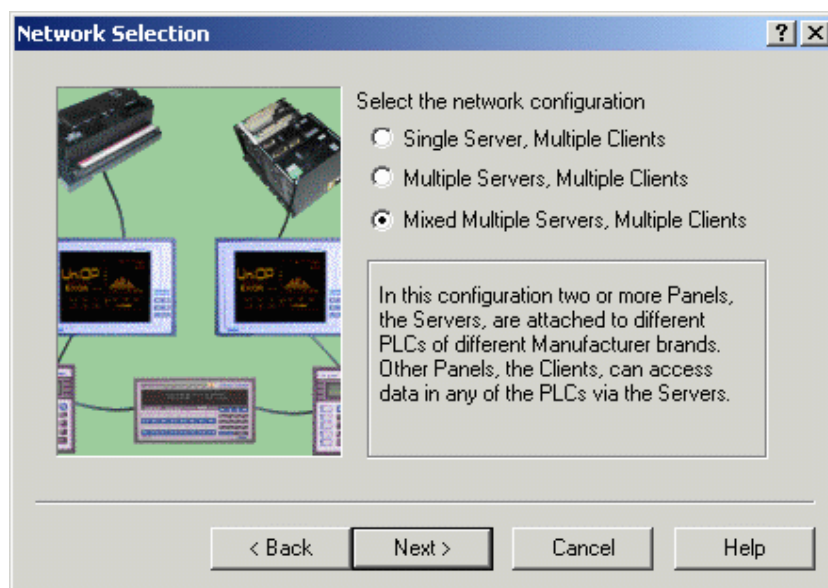

This advanced network type consists of more than one panel that is attached to controllers of different manufacturer brands (the servers) and one or more panels that are not attached to a controller (the clients). In this type of network, all of the clients and all of the servers can read and write data from and to every controller attached to a server in the network.

With this type of network, you have full control and flexibility over the network configuration using the Network Configuration dialog box. This allows you to make full use of the powerful capabilities of the network such as adding multiple servers for different controller manufacturer brands. This complete control over the network is gained at the expense of having to explicitly specify all of the configuration parameters for the network.

## 7.4.12 Network Types

### 7.4.13 Network Types

The Designer software supports two types of UniNET network: an RS485 network, or an Ethernet-based network.

#### 7.4.14 RS485

This network type must be used if the optional TCM10 board is not built into the panel. In this type of network, panels are interconnected using simple RS-485 cables.

Please refer to the Connecting Panels to a RS485 Network section to see how to build your RS485 UniNET Network.

#### 7.4.15 Ethernet

#### 7.4.16 Ethernet

The networking capabilities of the UniOP operator panels include connections to Ethernet-based networks. Ethernet is becoming a popular communication support for cell-level industrial controllers. There is no standard set in the industry for the application level protocol, but there are several non-compatible protocols. As the only common point, they are all based on the TCP/IP or UDP/IP protocols.

There are two main classes of applications where Ethernet networking capabilities can be successfully used:

Direct connection to Ethernet-based PLC networks

Extending the UniNET network

Note: UniOP panels can be successfully connected to an Ethernet-based PLC network only if the specific application layer protocol has been implemented.

The UniOP UniNET network is able to use Ethernet, when available, as the communication media.

The advantages of this type of network, as compared to conventional UniNET technology, are the ability to use existing network cables and a more effective solution for connecting a computer to the UniNET network.

Information is available on the TCM10 board (required to connect a UniOP panel to an Ethernet network), the UniNet OPC Server, and configuring Ethernet networks.

### 7.4.17 TCM10 Board

UniOP panels require an additional hardware module to connect to Ethernet networks. In an Ethernet network, panels are connected to a hub using standard UTP Ethernet patch cables. This network type is only available if the optional TCM10 board is built into the panel.

When the TCM10 communication module is used to extend the UniNET connectivity capabilities, the network setup follows the basic concepts of a normal UniNET network.

In addition, with the optional TCM10 card, you can implement a UniNET-over-Ethernet connection. The UniOP panel still communicates serially to the control device, but the communications between each UniOP are over a 10Base-T Ethernet connection.

TCM10 is intended for connection to 10Base-T networks (10 Mbit, twisted-pair cables). The TCM10 requires an external network adapter. The network adapter must be plugged into the Aux port of the UniOP panel. The TCM10 external network adapter is equipped with a standard RJ45 connector. The TCM10 can be directly connected to a hub using standard Ethernet twisted-pair patch cables.

The TCM10 external network adapter is equipped with a standard RJ45 connector. The TCM10 can be directly connected to a hub using standard Ethernet twisted-pair patch cables.

The TCM10 external network adapter has two diagnostic LED indicators:

LED	Description
RED - Link	When ON indicates that Ethernet link is missing. In this condition the GREEN LED is normally OFF.
GREEN - Activity	ON - No network activity for the UniOP panel Blink - Network activity detected for the UniOP panel

Compatibility information for the TCM10 module is available, as is information on configuring an Ethernet network.

### 7.4.18 Compatibility Information

Model	FW Type	Ethernet
MD00R-02	32	X
MD00R-04	32	X
MD00G-04	32	X
MD03R-02	32	X
MD03R-04	32	X
MD02F-02	32	X
MD02R-04	32	X
CP01R-04	32	X
CP02R-04	32	X
CP01F-02	32	X
CP02F-02	32	X
CP04F-04	32	X
CP10G-04	32	X

CP11G-04	32	X
CP12G-04	32	X
CP13G-04	32	X
EF-02	32	X
EF-04	32	X
ER-04	32	X
MKDF-02	32	X
MKDF-04	32	X
MKDR-04	32	X
MKDR-05	32	X
MKDG-06	32	X
MKDG-07	32	X
ePALM10	32	X
ER-16	33	
EL-16N	33	
ER-25	33	
ER-VGA	38	X
EL-25	33	
EL-VGA	38	X
BKDR-16	33	
BKDC-16	37	
BKDL-16	33	
BKDR-16T	33	
BKDC-16T	33	
BKDL-16T	33	
MKDR-16	33	
MKDL-16N	33	
MKDR-25	33	
MKDL-25	33	
MKDR-VGA	38	X
MKDC-VGA	38	X
MKDL-VGA	38	X
MKDT-VGA	38	X
ERT-16	33	
ECT-16	37	
ELT-16	33	
ER-25T	33	
EL-25T	33	
ERT-VGA	38	X
ECT-VGA	38	X
ELT-VGA	38	X
ETT-VGA	38	X
MKDR-VGA-T	38	X
MKDC-VGA-T	38	X
MKDL-VGA-T	38	X
MKDT-VGA-T	38	X
eTOP10	58	X
eTOP11	38	X
eTOP12	38	X

eTOP30	58	X
eTOP31	58	X
eTOP32	58	X
eTOP40	58	X

### 7.4.19 Configuring Ethernet

When a TCM10 communication module is used to connect a UniOP panel to an Ethernet-based PLC network, the Designer configuration is fully dependent on the protocol type used over the network. From the Designer point of view, the project needs to know the IP address of the TCM10 card and the IP addresses of the devices connected on the network with which the panel has to exchange information.

Configure Controller from the Project menu will normally allow configuration of the IP address of the communication partners of the UniOP that are connected over the Ethernet network. The Access Multiple Controllers checkbox in the Controller Setup dialog box (accessed by clicking the "..." button in the Configure Controllers dialog box then clicking on the Controller Setup button from the Select Controller dialog box) can be used when connection to more than one device is required.

Because the UniOP panel is a partner of the Ethernet network like all of the other devices, a proper IP address must be assigned to the panel. An IP address can be assigned to an Ethernet board from the External Devices tab in Panel Setup from the Project menu.

The IP address used in Configure Controller and in Panel Setup - External Devices has to be chosen according to the overall Ethernet configuration.

### 7.4.20 Connecting Panels to the Network

#### 7.4.21 Connecting Panels to the Network

The way panels are connected to the network depends on the connectivity adopted by the UniNET Network, i.e. if panels are to be connected via an RS485 UniNET Network or via an Ethernet UniNET Network.

#### 7.4.22 RS485

#### 7.4.23 Connecting Panels to an RS485 Network

The following sections describe how to connect panels to an RS485 UniNET Network.

Pinout for the PLC Communications Port

Pinout for the PC/Printer Communications Port

The TSI01 Bus Terminal with RS-232 to RS-485 Converter

The TSI02 Bus Terminal

RS-232 Cable to TSI01 Bus Terminal with Converter (Printer Port)

RS-232 Cable to TSI01 Bus Terminal with Converter (PLC Port)

RS-485 Cable to TSI02 Bus Terminal

Information is also provided on installing the network cable.

#### 7.4.24 Pinout for the PLC Communications Port

The PLC Communications port is used to connect client panels to the network using a bus terminal unit. The pinout of the PLC port is shown here for easy reference.

Note: Panels to be used as servers must have a dedicated PC/Printer port.

Pin #	Description	Pin #	Description
1	Frame Ground	9	
2	RXD	10	RTS
3	TXD	11	CTS
4	+5V	12	
5	Signal Ground	13	
6	CHA-	14	CHA+
7	CHB-	15	CHB+
8			

#### 7.4.25 Pinout for the PC/Printer Communications Port

Use the PC/printer communications port to connect server panels to the network using a bus terminal unit with an RS-232 to RS-485 converter. The pinout of the printer port is shown below.

Pin #	Description	Pin #	Description
1	Frame Ground	9	
2	RXD	10	RTS
3	TXD	11	CTS
4	+5V	12	
5	Signal Ground	13	
6		14	
7		15	
8			

**7.4.26 RS232 Cable to TSI01 Bus Terminal with Converter (Printer Port)**

Use the cable CA74 to connect the Printer port of a Server panel to the TSI01 bus terminal with converter. The maximum length of the cable is 12m.

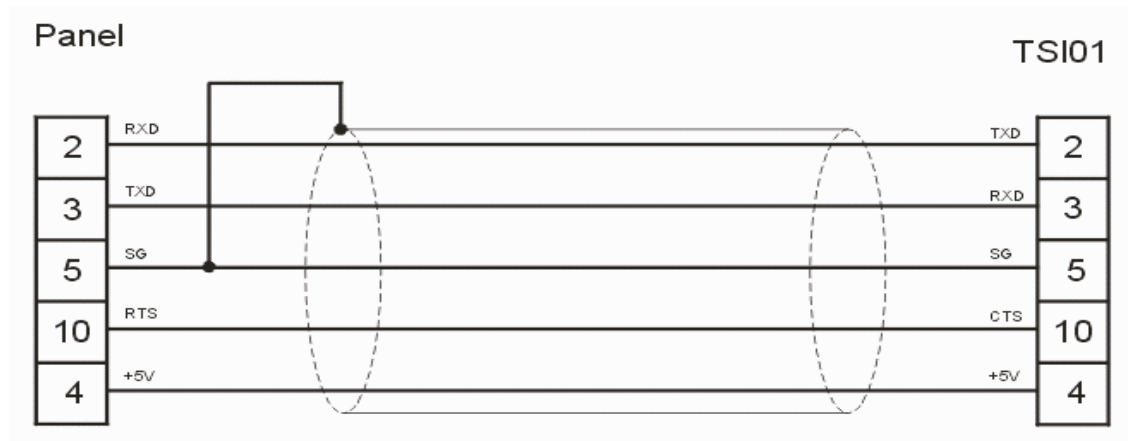

Panel connector: D-type 15P  
 TSI02 connector: D-type 15S

**7.4.27 RS-232 Cable to TSI01 Bus Terminal with Converter (PLC Port)**

Use the cable CA73 to connect the PLC port of a client panel to the TSI01 bus terminal with converter. The maximum length of the cable is 12m.

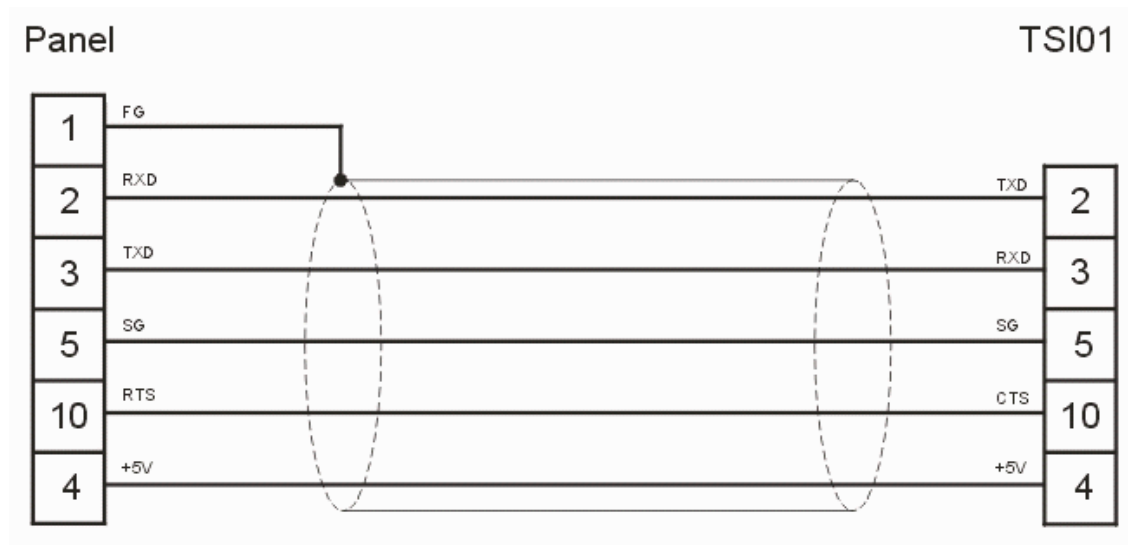

Panel connector: D-type 15S  
 TSI01 connector: D-type 15S



### 7.4.28 RS485 Cable to TSI02 Bus Terminal

Use the cable CA75 to connect the PLC port of a client panel to the TSI02 bus terminal. The maximum length of the cable is 1 m.

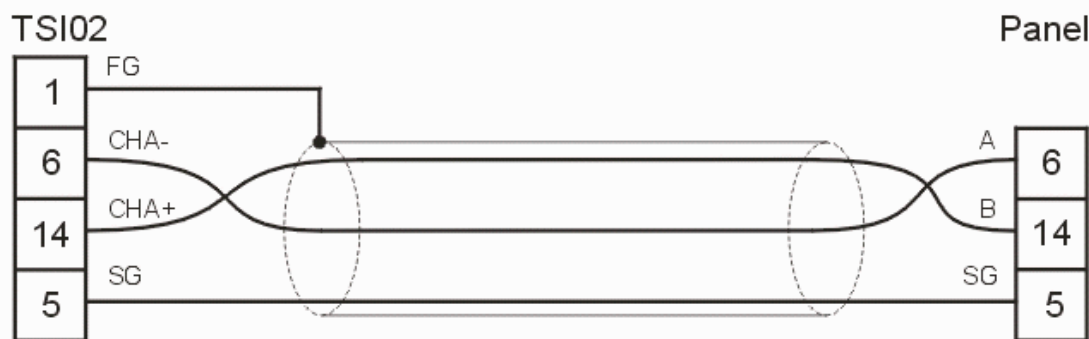

Panel connector: D-type 15S  
 TSI02 connector: D-type 15P

### 7.4.29 TSI01 Bus Terminal with RS-232 to RS-485 Converter

The TSI01 bus terminal is a special module designed for use in the UniNET network. It is an optically isolated RS-232 to RS-485 converter that can be directly connected to the Printer port of an operator panel. The power supply is derived from the panel connector; an on-board isolated DC/DC converter provides the power for the RS-485 section of the converter. The converter additionally provides the possibility of properly terminating the line with a simple switch.

The pinout of the RS-232 connector of the converter is shown below. The connector type is D-type 15 pin male.

Pin #	Description	Pin #	Description
1	Frame Ground	9	
2	TXD	10	CTS
3	RXD	11	
4	+5V external	12	
5	Signal Ground	13	
6		14	
7		15	
8			

The pinout of the RS-485 terminal block of the converter is shown in the following table.

Pin #	Description
1	Frame Ground
2	A (-)
3	B (+)
4	Shield

### 7.4.30 TSI02 Bus Terminal

The TSI02 bus terminal is a special module designed for use in the UniNET network. The use of the TSI02 bus terminal makes it easier to wire a panel to the network and additionally provides the possibility of properly terminating the line by means of a switch. The TSI02 has been designed for connection to the PLC port of an operator panel equipped with RS-485 interface.

The pinout of the RS-485 connector of the converter is shown below. The connector type is D-type 15 pin female.

Pin #	Description	Pin #	Description
1	Frame Ground	9	
2		10	
3		11	
4		12	
5	Signal Ground	13	
6	CHA-	14	CHA+
7		15	
8			

The pinout of the RS-485 terminal block of the converter is shown in the following table.

Pin #	Description
1	Frame Ground
2	A (-)
3	B (+)
4	Shield

### 7.4.31 Installing the Network Cable

The UniNET communication cable consists of a number of cable segments daisy-chained together connecting all the network nodes. The total length of the cable segments cannot exceed 1200 m. It is recommended to use a shielded cable with one twisted pair.

Note: Only a daisy-chained network is recommended. Other connections, for example a star-like connection, are not recommended.

The bus terminals at both ends of the networks must have the termination resistance connected with the switch. This connects the termination impedance (120 Ohms) that is built in each bus terminal. Intermediate bus terminals must not have the termination connected.

**7.4.32 Ethernet**

**7.4.33 Connecting Panels to an Ethernet Network**

To connect a Panel, including the TCM10 module, the Ethernet Adapter ETAD01 is needed as shown in the following picture.

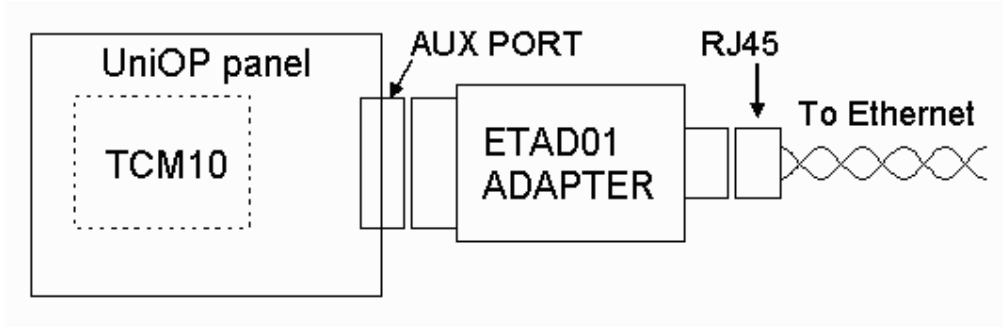

The second picture here below shows the ETAD01 wire connections.

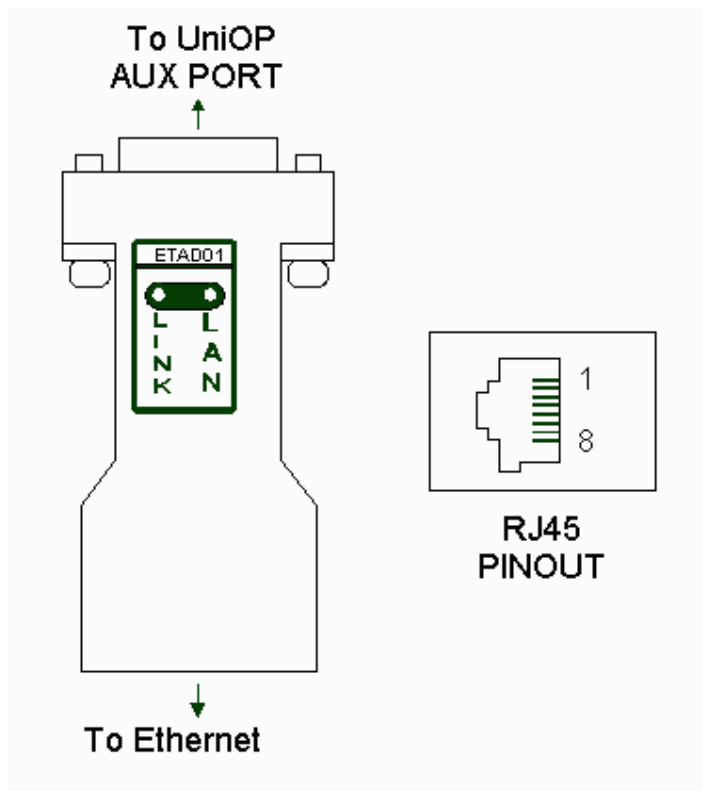

The ETAD01 Adapter connects on one site to the Panel AUX Port and provides on the other site a standard RJ45 8 way connector.

The following table shows the Pinout configuration.

Pin	Signal
-----	--------

1	TD out +
2	TD out -
3	RX in +
6	RX in -

#### 7.4.34 Network Setup

#### 7.4.35 Network Setup

It is easy to configure a UniNET network using Designer.

The configuration entails determining the type of network (RS-485 or Ethernet), specifying the number of clients and/or servers on the network, etc. The Network Protocol, Network Selection, and Network Configuration sections describe the steps necessary to configure the UniNET network.

Select Network Setup from the Project menu (or click the Network Setup icon on the toolbar) to configure or modify the network for your application. If a network is not yet defined for the project, this brings up the Network Media & Protocol Selection dialog box. If a network is already defined for your project, selecting Network Setup takes you directly to the Network Configuration dialog box.

#### 7.4.36 Network Protocol

The first step in configuring the network is selecting the network type. The Designer software supports two types of UniNET network: an RS-485 network, or an Ethernet-based network.

Select the type of network, click the Next> button, and the Network Selection dialog box appears.

#### 7.4.37 Network Selection

Select the appropriate network configuration for your project. Choices include:

Single Server, Multiple Clients

Multiple Servers, Multiple Clients

Mixed Multiple Servers, Multiple Clients

Once you have made your selection, click the Next> button.

If you choose Single Server, Multiple Clients or Multiple Servers, Multiple Clients, you will be prompted to enter the number of clients and/or servers for your project. You will then be prompted to click on the Configure button to bring up the Network Configuration dialog box, configured for the number of clients and servers specified. Check and set the remaining

configuration parameters for the network.

If you choose Mixed Multiple Servers, Multiple Clients you will be prompted to click on the Configure button to bring up the Network Configuration dialog box and specify all of the configuration parameters for the network.

#### **7.4.38 Network Configuration**

The parameters for the network are automatically configured if it is selected to be of either the Single Server, Multiple Client type or of the Multiple Server, Multiple Client (same controller types) type. However, Designer lets you make modifications to the network parameters by using the Network Configuration dialog box.

If you chose Mixed Multiple Servers, Multiple Clients, you must specify all of the configuration parameters for the network.

You can use the Import and Export buttons to share network configurations between multiple project files designed for the same network.

#### **7.4.39 Advanced Network Programming**

#### **7.4.40 Advanced Network Programming**

The UniNET network fully supports the use of all panel Reserved Data Areas (RDA), including alarms and mailboxes. Recipes may be used in a UniNET network system.

This section also provides information on Extending the Connectivity with the UniNET OPC Server.

#### **7.4.41 Reserved Data Area**

The UniNET network fully supports the use of all panel Reserved Data Areas (RDA), including alarms and mailboxes. These Reserved Data Areas can be placed in any controller attached to any server on the network. This is especially helpful since the RDA concept offers a simple and efficient method to have the controller program interact with the operator panel.

Note: Most RDA activities are carried out on a cyclical basis, so even with a small number of nodes in the network most of the network traffic may be for RDA updates. This may cause an exceedingly slow update time for displayed variables.

#### **7.4.42 Network and Recipes**

Recipes may be used in a UniNET network system. A single recipe may contain data items for different controllers attached to different servers on the network.

The following considerations should, however, be taken into account:

Recipe transfers may be considerably slower when they contain data items for controllers attached to other servers in the network than when they only contain data items for the controller attached directly to the operator panel.

The panels in the network can be configured so that they each store copies of the same recipe parameter set. In this case, special care must be taken to ensure the consistency of the parameter sets stored in the different nodes. It is recommended that in a network configuration, only one node be assigned for the storage of the recipe data.

#### **7.4.43 UniNET OPC Server**

#### **7.4.44 Extending the connectivity with the UniNET OPC Server**

The implementation of the UniNET network using Ethernet technology allows for an easy extension of the connectivity options of the system. One of the most important advantages of the Ethernet based technology is the availability of a UniNET Client for a computer.

The UniNET Client for a computer consists of a software component designed to work as a Client in the network. The software component is a program based on the OPC technology (OLE for Process Control) working as OPC Server. Once the software component is installed on the computer, all of the OPC Client programs will have full access to data coming through the UniNET Network. They can also fully interact with the Controllers connected to the UniNET Server panels.

This section provides information on the UniNET OPC Server and shows how this server can be accessed via OPC Automation Clients.

#### **7.4.45 UniNET OPC Server**

The UniNET OPC Server is a program that is distributed separately from Designer. The UniNET OPC Server program has the following minimum requirements:

Microsoft Windows 98, NT, ME or XP

15MB of free hard disk space

Ethernet card

The installation procedure of the UniNET OPC Server software components will automatically provide the registration of the Server at the system level. It will make the server visible to all of the OPC Clients that are already installed. Likewise, any OPC clients that are installed after the UniNET OPC server software is installed will also “see” the server.

The UniNET OPC Server main window appears as is shown here below.

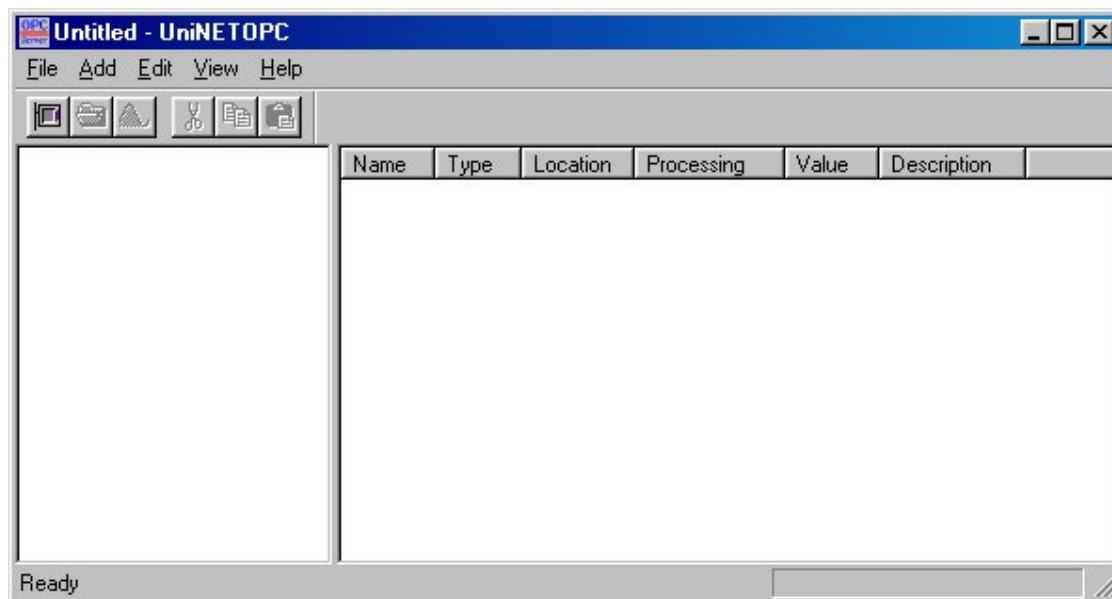

The OPC Server has to be properly configured in order to collect data coming from the UniOP panels working as UniNET servers on the network. The software uses the concepts of Device and Tag to identify the controllers connected to the server panels and the variables requested by them. These variables will be available to any OPC Client that may require their values. Please refer to specific OPC documentation for any additional detail regarding the theory of OPC technology.

Note: OPC Client programs installed on the computer will only have access to the Data Sets configured in the OPC Server application.

To create a new Device, select Add/New Device or click on the New Device icon. The Device Properties dialog box will be displayed as is shown in the next figure.



**Name**  
Represents a mnemonic description of the Device.

**Device**

The list box contains the list of all available drivers for the different controller types. Because OPC Server is a UniNET Client, the application needs to know the data structure of the controller connected to the UniOP UniNET Server panels.

#### Timeout

Period of time that the OPC server will wait to receive requested information before reporting a timeout error for the Device.

#### TCP/IP Access

Specifies if the UniNET network is Ethernet based. When the TCP/IP checkbox is not marked, the OPC server can be used to prepare a configuration file usable with the Windows CE OPC Server. Please refer to the specific documentation for further details.

#### IP Address

Represents the IP Address assigned to the UniOP Panel, working as UniNET Server, that is connect to the controller specified by the Device item. Please refer to the Networking with Ethernet section for a detailed description.

#### Socket Port

Represents the number of the socket port used by the UniOP panel to relay requests coming through the Ethernet network.

When the Device setup is completed, the OPC Server program has to be configured to read a certain amount of specific data from the UniNET network. Only this data will be available to an eventual OPC Client connected to the UniNET OPC Server. Required data from UniNET can be specified by inserting the Tags definition for the Device. To insert a Tag for the specific Device, use the Add/New tag menu or click on the New tag icon. The figure here below shows the Tag Properties dialog box.

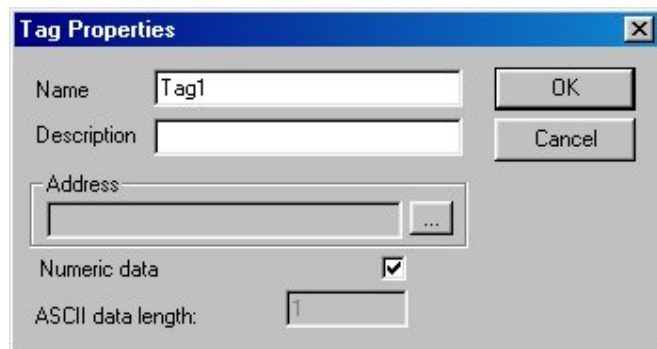

#### Name

The mnemonic name used by the OPC Server to uniquely identify the variable.

#### Description

Allows for the user to explain exactly to what the Tag refers.

#### Address

The tag address in terms of the native data types of the controller specified in the Device list box of the Device Properties dialog box.

#### Numeric Data

When marked, this specifies that the tag is to be treated like a numeric variable. When unmarked, it specifies that the variable is to be interpreted as the starting point of an ASCII



string. The ASCII data length specifies the length of the ASCII string. If the ASCII representation is selected, the OPC Server program will retrieve an amount of bytes equal to the number of ASCII characters specified by the ASCII data length parameter from the UniNET network.

The UniNET OPC Server program has a monitor function useful when a check of the Ethernet connection link is required. Once the Device and the Tags are configured, select View/Monitor to activate the debug function. The Value column of the main window (see Figure 39) displays the current value of each configured tag. If the OPC Server program cannot retrieve the value from the network, it displays the string Bad.

#### **7.4.46 Interfacing Microsoft Excel with the UniNET OPC Server**

As an application example, it is important to consider a typical use of the UniNET OPC Server. The program Microsoft Excel can be easily equipped with the OPC Automation software components that will allow connection to any OPC Server installed on the computer.

EXOR has successfully tested a solution provided by FactorySoft that is downloadable free of charge from the following web site: <http://www.factorysoft.com>. The Excel interface to the OPC Server consists in software components called OPC 2.0 Data Access Components. FactorySoft provides an Automation interface and a Server browser service.

##### Automation

FactorySoft wrote the Automation interface sample code for the OPC Foundation. They provide a standard Automation component based on this code for redistribution. An OPC Server vendor may use these components to provide its server.

##### Server Browser

This COM server returns OPC Servers by Component Category. It can be used to find Data Access 1.0 or 2.0 servers, in addition to future OPC servers. Because this is a COM server that can be run remotely, clients can get access to remote servers without local registry entries.

The FactorySoft OPC Data Access Components downloadable will install the Server Browser, the Data Access 2.0 proxy DLLs and the Automation DLL in the System directory.

This installation is used to install the OPC components needed for the server and can be freely distributed with your products.

Once the required software components are correctly installed, the VBA (Visual Basic for Application) interface available in Excel can be easily used to give access to the UniNET OPC Server.

The read operation can be implemented using a simple form where a button is programmed to perform the following "Get OPC Data" subroutine.

```
Private Sub GetOpcData_Click()  
  
'Get OPC Automation Reference  
Set opcauto = CreateObject("OPC.Automation.1")
```

```
'Connect to the server
opcauto.Connect ("EXOR.UniNETOPC")

'Plays with groups and items
Set groups = opcauto.OPCGroups
Set group = groups.Add("Device1.Group")
group.IsActive = True
Set Items = group.OPCItems
Set Item = Items.AddItem("Device1.Group.tag1", 1)
Item.Read (1)
value = Item.value

'Display value
Sheet1.Range("a1").value = value
End Sub
```

A working sample program is available on request.

#### **7.4.47 Network Examples**

#### **7.4.48 Network Example**

Most of the features of the UniNET Network can be tried by using a very simple configuration. This example will describe the steps required to set up a simple UniNET network composed of a single server operator panel connected to a controller and two client operator panels that will access the controller data via the server through the network services.

The complete network system is composed of three operator panels. Thus, we will have to create individual project files for each of the three panels. All three project files must include the same network configuration information in order for the three panels to exchange information. To ensure that the project files contain the same network configuration information, we will define the network configuration once in the first project file and save the configuration. Then we will import the configuration into the other two project files.

The example is broken down into the following steps:

Setting Up the Network Configuration

Creating the Project File for the Server

Creating the Project File for the First Client

Creating the Project File for the Second Client

Running the Network

#### **7.4.49 Setting Up the Network Configuration**

Select New from the File menu and create a new file.

Select the Configure Controller from the Project menu and choose the controller type required for the server.

Select Network Setup from the Project menu.

Select RS485 as the type of network.

Click Next>.

Choose the option Single Server, Multiple Clients.

Click Next>.

Enter 2 for the number of clients.

Click Next>.

Click Configure to change the default node settings and complete the network configuration.

The Network Configuration dialog box appears, showing the network configuration with the list of nodes.

Click on the Enable UniNET Network checkbox.

A checkmark appears next to node number 1 indicating that it is the server.

Select node number 2.

Click Properties.

The Edit Panel Node dialog box opens. Select the controller for panel node 2 (a client), and set the other parameters as necessary.

Click OK.

A cautionary message appears. Click Yes.

Repeat steps 14-18 for panel node number 3.

Click on the Export button.

Give the network configuration file a name with the .net extension in a convenient folder. Click Save to save the file and return to the Network Configuration dialog box.

Click OK to close the Network Configuration dialog box.

Click the Finish button to complete the network setup process and close the Network Selection dialog box.

(Continued in Creating the Project File for the Server)

### 7.4.50 Creating the Project File for the Server

(Continued from Setting Up the Network Configuration)

Create a page for the application. Type some text on the page, then insert a numeric data field by selecting Insert - Data Fields - Numeric/ASCII.

Use the cursor to outline an area for the data field.

In the Numeric Field Properties dialog box click on the Range tab. Set the Access as Read/Write.

Click OK.

Save the file by selecting Save from the File menu.

Close the file by selecting Exit from the File menu.

Connect the computer to the operator panel that is designated as the server and download the project. When the transfer is complete, detach the cable from the PC/Printer port of the panel and connect the RS-232/RS-485 converter.

Note: Since the PLC port is used on the server to connect to the controller, the only available port for the network connection is the PC/Printer port (the AUX port cannot be used). The PC/Printer port only has a 232 interface, but the UniNET network is 485. Thus, the converter is required.

(Continued in Creating the Project File For the First Client)

### 7.4.51 Creating the Project File for the First Client

(Continued from Creating the Project File for the Server)

Repeat steps 1 through 11.

Click on the Import button in the Network Configuration dialog box.

Select the file created in step 21 and click Open.

The controller information is copied into this new file.

Check the Enable UniNET Network button.

Click OK to close the Network Configuration dialog box.

Click the Finish button to complete the network setup process and close the Network Selection dialog box.

Create a page for the application. Type some text on the page, then insert a numeric data field by selecting Insert - Data Fields - Numeric/ASCII.

Use the cursor to outline an area for the data field.

In the Numeric Field Properties dialog box click on the Range tab. Set the Access as Read/Write.

Click OK.

Save the file by selecting Save from the File menu.

Close the file by selecting Exit from the File menu.

Connect the computer to the operator panel that is designated as the first client and download the project.

Note: The panel may need to be attached to the network through its PLC port, depending upon the network port selected for the client in the project.

(Continued in Creating a Project File for the Second Client)

### **7.4.52 Creating the Project File for the Second Client**

(Continued from Creating the Project File for the First Client)

Repeat steps 1 through 11.

Click on the Import button in the Network Configuration dialog box.

Select the file created in step 21 and click Open.

The controller information is copied into this new file.

Check the Enable UniNET Network button.

Click OK to close the Network Configuration dialog box.

Click the Finish button to complete the network setup process and close the Network Selection dialog box.

Create a page for the application. Type some text on the page, then insert a numeric data field by selecting Insert - Data Fields - Numeric/ASCII.

Use the cursor to outline an area for the data field.

In the Numeric Field Properties dialog box click on the Range tab. Set the Access as Read/Write.

Click OK.

Save the file by selecting Save from the File menu.

Close the file by selecting Exit from the File menu.

Connect the computer to the operator panel that is designated as the second client and download the project.

Note: The panel may need to be attached to the network through its PLC port, depending upon the network port selected for the client in the project.

(Continued in Running the Network)

## 7.4.53 Running the Network

(Continued from Creating the Project File for the Second Client)

Once all three panels are in Operation Mode they should display the variable on the screen. In the case of the client panels, the variable is read from the controller after the server receives a request from the client to read the data.

Verify that none of the three panels report any communication errors.

The variable itself may be modified using the Data Entry Mode. Changing the value of the data from any operator panel will change the display on the other panels.

## 7.5 Panel Fonts

### 7.5.1 Panel Fonts

It is possible to have up to 4 different panel fonts on certain UniOP panels. The Select Font dialog box lets you select a font from a pull-down list.

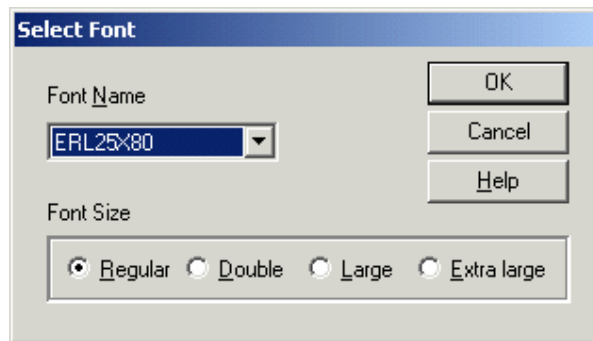

Note: If a project file contains panel font components, switching to a standard font (not an enhanced font) will erase all of the panel font components in the project.

Installing New Panel Fonts

Downloading Panel Fonts

Compressing Panel Fonts

## 7.5.2 Installing New Panel Fonts

### 7.5.3 Installing New Panel Fonts

Panel fonts, as all of our standard fonts, are associated with the various display types. To add a new font, copy the .FON file inside the working directory that contains the Designer.EXE file. You must also modify the DISPLAYS.INI file as described below.

```
DISPLAYS.INI
[DTYPE25]
...
CharHeight=16
CharWidth=8
...
[DTYPE25 Fonts]
ERL25X80=ERL25X80.FON
UniCOMIC=UniCOMIC.fon
Uni7SEG=Uni7SEG.fon
[Uni7SEG Font]
BargraphStart=226
BoxChars=218,191,192,217,196,179,196,179,180,194,193;201,187,200,188,205,186,205,1
86,0,0,0
BigCharStart=128
```

### 7.5.4 Character Size

#### 7.5.5 Panel Font Character Size

Some panels use an 8x16 character size and other panels use an 8x15 character size. A font that has an 8x16 character size cannot be used on a UniOP that supports only an 8x15 character size and vice versa.

The panel characters size can be found inside the [DTYPEnn] section. The DTYPE code used for a particular panel can also be found by reading the panel database file.

All new fonts must be declared inside the [DTYPEnn Fonts] section and a new [<Font Name> Font] section with the necessary graphic character codes must be added. The necessary graphic character codes to be used are shown below.

Uni7Seg Font

UniComic Font

#### 7.5.6 UniComic Font

Normal: Courier New (only first 127 characters)  
Double: Comic Scans MS

Large: Comic Scans MS  
Extra Large: Comic Scans MS  
Basic font for 8x16 panel type: ERL25x80.FON  
[UniComic Font]  
BargraphStart=226  
BoxChars=218,191,192,217,196,179,196,179,180,194,193;201,187,200,188,205,186,205,186,0,0,0  
BigCharStart=128  
Basic font for 8x15 panel type: SH164015.FON  
[UniComi5 Font]  
BargraphStart=226  
BoxChars=218,191,192,217,196,179,196,179,180,194,193;201,187,200,188,205,186,205,186,0,0,0  
BigCharStart=128

### 7.5.7 Uni7Seg Font

Normal: Courier New (only first 127 characters)  
Double: Ni7Seg  
Large: Ni7Seg  
Extra Large: Ni7Seg  
Basic font for 8x16 panel type: ERL25x80.FON  
[Uni7SEG Font]  
BargraphStart=226  
BoxChars=218,191,192,217,196,179,196,179,180,194,193;201,187,200,188,205,186,205,186,0,0,0  
BigCharStart=128  
Basic font for 8x15 panel type: SH164015.FON  
[Uni7SEG5 Font]  
BargraphStart=226  
BoxChars=218,191,192,217,196,179,196,179,180,194,193;201,187,200,188,205,186,205,186,0,0,0  
BigCharStart=128

### 7.5.8 Downloading Panel Fonts

Designer automatically downloads panel fonts along with the project file whenever panel fonts have been used. These fonts will be downloaded to the UniOP panel each time the project file is downloaded.

If these fonts have already been downloaded, it is not necessary to re-download them. To save time, from the Transfer menu select Options. Click on the Transfer Advanced tab.



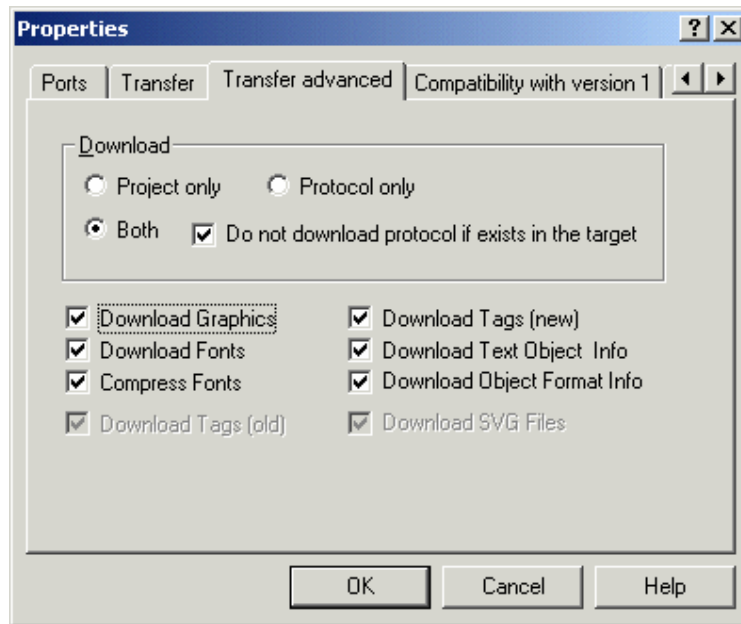

Uncheck the Download Fonts checkbox, and the panel fonts will not be downloaded.

### 7.5.9 Compressing Panel Fonts

In order to save memory in the UniOP panel, Designer automatically compresses the panel font files that it downloads.

If necessary, you can disable this optimization by selecting Transfer - Options.

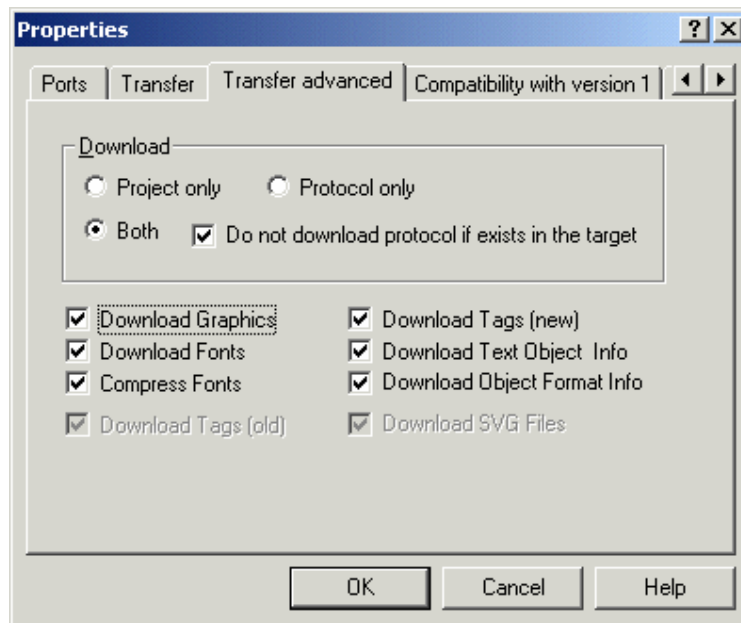

Click on the Transfer Advanced tab and uncheck the Compress Fonts checkbox.

Note: Font optimization will be automatically disabled when PLC references in ASCII format are used.

## 7.6 Printing

### 7.6.1 Printing

You can use Designer to configure your UniOP panel to print reports either cyclically or upon a trigger event. You can define report formats and timetables upon which a report is printed, configure a key or touchcell to print a report, or request a printout by using the Interlock Mailbox.

Note: In order to use these print features, your panel must contain firmware version 4.10 or higher.

Information on setting up a new printer, printing reports, and a printer setup example are provided.

### 7.6.2 Printer Setup

To set up a serial printer, select Project - Report on Panel Printer - Printer Setup. This will display the Printer Setup dialog box.

From this dialog box, you can choose the printer you will be using, set the communication parameters, and define the page size.

If you will be using a printer that is not listed, you can use the Add button to add a new printer to the list of available printers. Doing so will bring up the Printer Properties dialog box in which you can define the parameters for the newly added printer. Similarly, you can use the Edit button to redefine the parameters for an existing printer.

Note: If you will be printing reports, the paper height should be defined here before the report is defined. If you change the paper height with some reports already defined, the report layouts that have already been defined will not automatically be rearranged.

### 7.6.3 Reports

### 7.6.4 Reports

A report is a collection of project file pages (or parts of project file pages). Each report is divided into two parts. One is a common part, such as the header and footer. These will be common to each and every page of the report. The second is the display page that is the body of the report.

Creating a New Report

Setting Up Report Headers & Footers

Advanced Report Parameters

Triggering a Report Printout

### **7.6.5 Creating a New Report**

To define a report, select Project - Report on Panel Printer - Reports. Add a report by clicking the New button. You can rename the report with a more descriptive name if you wish by single-clicking on the report name, then typing in a new name.

All of the pages of your project file will be shown on the General tab in an "Available Pages" box on the left. To add a page to the report you are creating, select the page and click on the Add-> button. Doing so will place the page name into the "Report Pages" box on the right.

By selecting a page from the "Available Pages" box and pressing the Properties button, you can specify what part of the project file page to print and where to start printing on the page.

### **7.6.6 Setting Up a Report Header and/or Footer**

The structure of the header and the footer are the same. It is possible to define the height of the header and the footer, and several predefined fields that can be inserted into the header or footer.

Under the Header and Footer tabs you can specify the height of the header/footer, the fields that are inserted into the header/footer, where they are inserted at and how they are positioned.

Fields that can be inserted include the time and date, the page number, the report name and a label (which allows you to enter static text).

### **7.6.7 Advanced Report Parameters**

Under the Advanced tab you can set up various parameters that are common for every page in the report.

These include whether or not to wrap lines, the default font, how to transform various attributes, what to do with non-printable characters, etc.

### **7.6.8 Triggering a Report Printout**

A report printout can be triggered in three different ways:

With a macro that is associated to a function key or a touch cell.

Cyclically at a specified time.

From a PLC request issued through the Interlock Mailbox.

To set up a report to be printed when a function key or touch cell (use commands from the Insert menu to create the touch cell), select Keyboard Macro Editor from the Project menu. In the Macro Editor dialog box there is a macro command entitled Print Report.

Select a tab to correspond to the page where you want the trigger to be placed. From the Commands toolbar, select the Print Report icon. The Choose Report dialog box appears, where you can select which report is to be printed when this key (or touch cell) is pressed.

Any report can be printed cyclically in two different modes: any day at a specific time or cyclically after an interval of time.

You can set a cyclical trigger by selecting Project - Report on Panel Printer - Triggers.

The third way to start a report printout is to use the Interlock Mailbox. This can be accessed from Project - Panel Controller Interface, then selecting the Interlock Mailbox tab and using the mailbox command Start Report Printout.

Use the command Stop Report Printout to stop printing.

### **7.6.9 Printer Setup Example**

In this example we will add a new printer and set up a print sequence using the Keyboard Macro Editor.

Select Project - Report on Panel Printer - Printer Setup.

Initially only a generic printer is listed, so we will add a new printer to the list. Press the Add button and the Printer Properties dialog box appears.

Enter a name for the new printer in the Printer name box.

Enter an escape sequence for the new printer in the Escape sequences box.

Click OK.

Enter a file name for the printer file.

Click OK.

Verify the communication parameters.

Set the page size.

Click OK.

Now we need to define a report to print. Select Project - Report on Panel Printer - Reports. Add a report by clicking the New button.

Single-click on the report name, then type in a new, more descriptive, name.

Click on a report page on the left side of the General tab to select it. Press Add-> to add that page to the report list on the right side of the tab.

Click on the page name in the right-hand list and click on Properties.

Set the page properties such as spacing, fonts, etc.

Click OK.

Click on the Header tab.

Select several fields under Field Type to include on the page header.

Click on the Footer tab.

Select several fields under Field Type to include on the page header.

Click on the Advanced tab.

Verify the print settings, then click OK.

Next we program a macro to print the report when function key F22 is pressed. Select Keyboard Macro Editor from the Project menu.

In the Macro Editor dialog box on the All Pages tab select panel key F22.

Under Commands, select Print Report.

Choose the report to be printed when key F22 is pressed.

Click OK to return to the Macro Editor.

Click OK to close the Macro Editor.

The project is now set up to print the selected report whenever panel key F22 is pressed.

## 7.7 RDA

### 7.7.1 RDA

The UniNET network fully supports the use of all panel Reserved Data Areas (RDA), including Alarms and Mailboxes.

These Reserved Data Areas can be placed in any controller attached to any server on the network.

The RDA concept offers a simple and efficient method to have the controller program interact with the operator panel.

See the RDA Setup section for additional information on the use of the RDA in Designer.

Note: Since most RDA activities are carried out on a cyclical basis, even with a small number of nodes in the network the result may be that most of the network traffic will be for RDA updates. This may cause an exceedingly slow update time for displayed variables.

Each UniOP panel may use up to three small reserved areas of controller memory to establish an interface with the controller. These three reference areas are: Keys, Panel, and PLC. You can select the starting address of each of these areas.

The figure below illustrates the flow of communication for each of the reserved data areas.

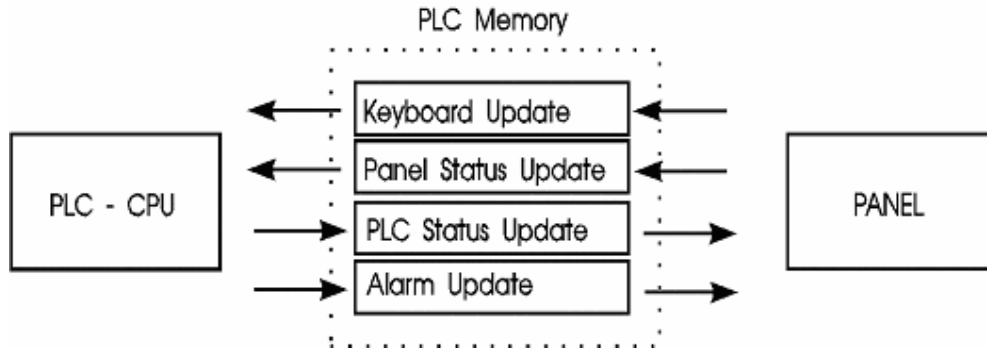

A memory map of the entire reserved data area is shown below.

	bit 15	14	13	12	11	10	9	8	7	6	5	4	3	2	1	bit 0	
<b>KEYBOARD UPDATE AREA</b>	0	F16	F15	F14	F13	F12	F11	F10	F9	F8	F7	F6	F5 <sub>E</sub>	F4 <sub>D</sub>	F3 <sub>C</sub>	F2 <sub>B</sub>	F1 <sub>A</sub>
	1	F32	F31	F30	F29	F28	F27	F26	F25	F24	F23	F22	F21	F20	F19	F18	F17
	2	7	6	5	4	3	2	1	0	K4	K3	K2	K1	up	dwn	right	left
	3	K16	K15	K14	K13	K12	K11	K10	K9	K8	K7	K6	K5	+/-	.	9	8
<b>PANEL STATUS AREA</b>	4	Reserved Byte							Day of the week								
	RTC	Day							Month								
	RTC	Year							Hour								
	RTC	Minute							Second								
	Panel Status Word	S15	S14	S13					S8	S7	S6	S5	S4	S3	S2	S1	S0
		CP (Current page)															
		Reserved Word															
		Reserved Word															
<b>CONTROLLER UPDATE AREA</b>	14	PR (Page request)															
	LED Control	L16	L15	L14	L13	L12	L11	L10	L9	L8	L7	L6	L5	L4	L3	L2	L1
	LED Control	L32	L31	L30	L29	L28	L27	L26	L25	L24	L23	L22	L21	L20	L19	L18	L17
	Controller Control Word	C15	C14	C13	C12	C11	C10	C9	C8	C7	C6	C5	C4	C3	C2	C1	C0
		Reserved Word															
		Reserved Word															
		Reserved Word															
	<b>ALARM UPDATE AREA</b>	21	A16	A15	A14	A13	A12	A11	A10	A9	A8	A7	A6	A5	A4	A3	A2
22		A32	A31	A30	A29	A28	A27	A26	A25	A24	A23	A22	A21	A20	A19	A18	A17
		----- (break) -----															
35		A240	A239	A238	A237	A236	A235	A234	A233	A232	A231	A230	A229	A228	A227	A226	A225
36		A256	A255	A254	A253	A252	A251	A250	A249	A248	A247	A246	A245	A244	A243	A242	A241

As shown in the two previous pictures, the four Reserved Data Areas are:

Keyboard Update Area

Panel Status Area

Controller Update Area

### 7.7.2 Keyboard Update Area

This reserved area is formatted to contain flags for each key on the panel and extended keyboard. These flags are set HIGH when a key is pressed and set LOW when released.

Each key status flag occupies one bit in the controller memory. These bits can be used by the controller to detect when a particular key has been pressed and then in turn perform a specific operation. It is recommended to use the Keyboard Macro Editor to program keys. This method is easier and more efficient than programming a key using ladder logic.

Note: In the Keyboard Update Area of the RDA, the ENTER key is mapped to K1, the CLEAR key is mapped to K16, and the HELP key is mapped to K15.

### 7.7.3 Panel Status Area

### 7.7.4 Panel Status Area

This reserved area is formatted to contain time and date information from the panel's Real Time Clock, a two-byte Panel Status Word, and a Current Page Register.

### 7.7.5 Panel Status Area

This reserved area is formatted to contain time and date information from the panel's Real Time Clock, a two-byte Panel Status Word, and a Current Page Register.

### 7.7.6 Real Time Clock

The real time clock contains the time and date information.

### 7.7.7 Panel Status Word

### 7.7.8 Panel Status Word

The panel sets and resets bits S0-S8 and S13-S15 in the Panel Status Word to indicate its current status. Your application logic can monitor these bits to determine how and when it should interact with the panel. The following table has a brief description of each status bit.

Bit #	Function
S0	Link status monitor flag
S1	Data entry active
S2	Printing in progress
S3	Printer status
S4	Date and time update in progress
S5	Attempt to access protected function
S6	Battery low
S7	Alarm active
S8	Unacknowledged alarm active
S12	Recipe and event backup in progress



S13	Recipe upload in progress
S14	Recipe download in progress
S15	Recipe file status

### 7.7.9 S0 Link Status Monitor Flag

Bit S0 in the Panel Status Word can be used by the controller to monitor the communication status between the panel and the controller. The value of this bit is changed by the panel with a cycle time of approximately one second. If a transition is not detected within one second, the controller should consider that the panel is either not connected or not operating properly.

Note: If the cycle time of the controller program is longer than one second or if there are numerous communication errors, one transition of the Link Status flag can go undetected.

### 7.7.10 S1 Data Entry Active

Bit S1 is set whenever the panel is in Data Entry Mode.

### 7.7.11 S2 Printing in Progress

Bit S2 is set whenever the panel is in the course of sending data to the printer.

### 7.7.12 S3 Printer Status

Bit S3 of the Panel Status Word contains the current logic state of the CTS (clear to send) line. This line is being driven by the printer and indicates the printer's readiness to accept data.

### 7.7.13 S4 Date and Time Update in Progress

Bit S4 in the Panel Status Word is used to synchronize access to the panel's real time clock (RTC).

Before writing a new time and date record, the panel sets bit S4 in the Panel Status Word to indicate that it is about to update this data. The panel then writes the time and date information to the Reserved Data Area (RDA) and resets bit S4. The controller program should always check the update flag before reading the time and date record. If the bit is set, the controller should not use the time and date information.

Note: This bit is not set when the panel updates only the "seconds" field.

### 7.7.14 S5 Attempt to Access Protected Function

Bit S5 of the Panel Status Word is set when the panel user tries to access a function that is not accessible with the current password. Since in this case no message is displayed by the panel itself, the controller can be used to check this status bit and notify the user that the function they are trying to access is protected.

### 7.7.15 S6 Battery Low

Bit S6 of the Panel Status Word is set when the backup batteries become weak. These batteries maintain recipe data as well as time and date information, which is stored in RAM.

### 7.7.16 S7 Alarm Active

Bit S7 of the Panel Status Word is set when at least one alarm is active. Bit S7 is reset when all alarm bits are reset to zero.

### 7.7.17 S8 Unacknowledged Alarm Active

Bit S8 of the Panel Status Word is set whenever there is at least one active alarm that requires acknowledgment. It is reset when all alarms have been acknowledged.

Note: Enabling the Operator ACK Required attribute when creating alarm messages guarantees that bit S8 will remain set until the alarm is acknowledged. It does not guarantee that the bit associated with the alarm in the RDA will remain set. Those alarm bits are controlled by application logic, not by the panel.

### 7.7.18 S13 Recipe Upload in Progress

Bit S13 is set whenever a recipe is being uploaded from the controller into the panel. It is reset whenever the upload process is complete.

### 7.7.19 S12 Recipe and event backup in progress

The S12 bit of the RDA area is used to communicate to the controller when a backup operation to flash memory is in process. The UniOP will set this bit to 1 just before the backup operation begins. When the backup operation is complete, UniOP will set this bit to 0.

Recipe/Event Backup:

0 = Standby

1 = Backup operation in progress

### **7.7.20 S14 Recipe Download in Progress**

Bit S14 is set whenever a recipe is being downloaded from the panel into the controller. It is reset whenever the download process is complete.

### **7.7.21 S15 Recipe File Status**

Bit S15 displays the Recipe File Status. A "0" indicates that the recipes contain valid data. A "1" indicates that the recipe data is corrupt or still contains the default values defined in the project file.

### **7.7.22 Current Page Register**

The panel writes the number of the currently displayed page into the CP register whenever the panel is in Page mode or Data Entry Mode. In all other modes, a zero is written into this register, indicating that page data is not currently being displayed.

Note: Page numbers are stored in either binary or BCD format, depending on the controller being used.

### **7.7.23 Controller Update Area**

#### **7.7.24 Controller Update Area**

The Controller Update Area allows the controller to access and control certain aspects of the panel. All front panel LED's can be controlled from this area to provide feedback to the operator. The controller may also request a specific page to be displayed by writing the appropriate value into the Page Request Register. The Controller Control Word allows the controller to request the printing of a page, disable data entry, select an alarm mode, or enable the mailbox function.

All panels include a standard set of dedicated indicators that allow the user to monitor the status of the panel. Along with these dedicated indicators, certain models include a subset of user defined LED's that can be monitored and controlled by your application logic. The control of these LED's is carried out through the Controller Update Area. Each of the registers found there can be copied to bit address contacts so that the status bits can be referenced as control relays.

### **7.7.25 LED Control Bits**

### **7.7.26 LED Control Bits**

Bits L1 through L32 control the LED indicators that can be found on various panel models. The mappings of these bits are listed below

Two tables show how LED's are mapped, the LED Map for All Panels Except Eight User LED's and the LED Map for Eight User LED's. For example, the F1 key is mapped to L1 and the 0 numeric key is mapped to L17. All of the panels except those that have eight user LED's are mapped according to this table.

### 7.7.27 LED Map for All Panels

LED	Key
L1	F1
L2	F2
L3	F3
L4	F4
L5	F5
L6	F6
L7	F7
L8	F8
L9	F9
L10	F10
L11	F11
L12	F12
L13	F13
L14	F14
L15	F15
L16	F16
L17	0
L18	1
L19	2
L20	3
L21	4
L22	5
L23	6
L24	7
L25	8
L26	9
L27	.
L28	+/-

### 7.7.28 LED Map for Eight User LEDs

The mapping in the following table represents panels that have eight user LED's.

LED	KEY
L1	F1
L2	F2
L3	F3
L4	F4

L5	F5
L6	F6
L7	F7
L8	F8
L9	F9
L10	F10
L11	F11
L12	F12
L13	F13
L14	F14
L15	F15
L16	F16
L25	USER LED 0
L26	USER LED 1
L27	USER LED 2
L28	USER LED 3
L29	USER LED 4
L30	USER LED 5
L31	USER LED 6
L32	USER LED 7

### 7.7.29 Page Request Register

The page to be displayed can be selected either by the operator from the front panel keypad or by the controller itself.

The controller selects the page to be displayed by writing the corresponding page number into the PR register in the Controller Update Area. Note that once the panel has changed to the corresponding page, the user needs to write a 0 back into the PR register in order to return control back to the keys on the panel. If this is not done, the user will be 'stuck' on that page. When the panel detects a page request from the controller, it checks the front panel keyboard and the Expanded Keyboard (if present). If no key has been pressed for the last three seconds, the page selected by the controller is displayed.

While a controller page request is active (PR not 0), the operator will not be able to change pages using the arrow keys.

Note: Page numbers are stored in either binary or BCD format, depending on the controller being used.

### 7.7.30 Controller Control Word

#### 7.7.31 Controller Control Word

The bits of the Controller Control Word are set and reset by the controller according to the application logic. The panel responds to these bits as shown in the following table.

Bit #	Function
C0	Print Screen
C1	Disable Data Entry
C2	Select Alarm Mode
C6, C7	Buzzer handling
C15	Enable Mailbox

### 7.7.32 C0 Print Screen

When bit C0 in the Controller Control Word is set, the panel sends the currently displayed page to the printer. The bit must be reset to 0 before another print request can be processed.

Note: If the current password enables the user to request printouts, the currently displayed page can be printed directly from the front panel by pressing the "Prt Scr" or "9 / PRT" keys (depending on the panel model).

### 7.7.33 C1 Disable Data Entry

When bit C1 in the Controller Control Word is set, the operator cannot enter the Data Entry Mode on the panel, even if the password otherwise enables them to do so. In this way, the controller can temporarily or permanently inhibit modification of variable values in a way defined by its program.

### 7.7.34 C2 Select Alarm Mode

When C2 is set, the display will NOT switch to Alarm mode automatically. Instead, the operator will have to select ALARM from the Panel Command menu with the proper keyboard actions. Once inside the ALARM menu, the user will be able to view and acknowledge any active alarms (If there are no pending alarms, the user will not be able to enter the ALARM menu). When the bit is reset to zero, the display will automatically switch to Alarm mode when at least one alarm is active.

Note: Bit C2 only disables the automatic display of the alarm screen. Any alarm attributes that were set during project development remain active.

### 7.7.35 C15 Enable Mailbox

Setting bit C15 enables the panel to cyclically read the data in the Mailbox. Note that the Mailbox must be configured prior to setting this bit (see Chapter 8). When this bit is not set, the panel will not read the data in the Mailbox, thus reducing communication time and increasing system performance.

### 7.7.36 Buzzer handling

The PLC Control Word of RDA block, bit C6 & C7 are used for buzzer control through PLC. By setting C6, buzzer control is given to PLC and the PLC switches the buzzer on/off using C7 bit.

Two bits are used for this i.e.

Enable bit:

bit = 0 buzzer standard,  
bit = 1 control from PLC

Control bit:

if Enable bit = 1, then

bit = 0 buzzer off,  
bit = 1 buzzer on

## 7.8 Recipes

### 7.8.1 Recipes

Data may be stored inside a panel in data retentive memory. The available amount of data retentive memory varies depending on the UniOP model. This data retentive memory can be used to permanently store data for use by an attached controller. This data can be written to the controller, and, conversely, the data can be read from the controller and then placed in the data retentive memory. This concept is termed "Recipes" and offers a powerful way to extend the capabilities of the controller. This is especially true for controllers that have a limited amount of internal memory.

Recipes are configured by adding the required controller data items to a page as recipe data fields. A recipe can be associated with a particular page and is composed of all the recipe data items on that page. Recipe data items contain all the information associated with normal controller data fields, but rather than the data being read and written directly to the controller during the course of normal operation, the data is instead read from and written to the UniOP memory that is reserved for the data item. Only when the UniOP panel is explicitly asked to write the data to the controller is the data sent to the controller. Similarly, only when the UniOP panel is explicitly asked to read the data from the controller is the data actually read from the controller.

Working with Recipes

Inserting Recipe Data Fields

Configuring Recipe Parameter Sets

Recipes and Control Variables

Recipes and the Keyboard Macro Editor

Recipe Menu

Recipes and the Interlock Mailbox

Multipage Recipe Support

Recipes and Events Backup in Flash

Recipe Examples

## **7.8.2 Working with Recipes**

Setting up a recipe, although not particularly complex, does involve several steps. These include:

Inserting recipe data fields

Configuring recipe data fields

Creating a Recipe Menu

Programming the Recipe Menu using the Keyboard Macro Editor

Downloading the recipe to the panel

## **7.8.3 Inserting Recipe Data Fields**

Before any other recipe actions can take place, a recipe data field must exist in a project. To add a recipe data field, use Insert - Data Fields to add a Numeric/ASCII, Bargraph, or Message Data Field and set the Reference type as Recipe.

Before a recipe can be configured, a recipe data field must be inserted into a project. Recipe data fields can be added to a page from the Data Fields submenu under the Insert menu. From the Data Fields submenu, select either Numeric/ASCII, Bargraph, or Message.

From the Data Field Properties dialog box, you can specify that the data field be of Reference type PLC, a panel Control Variable, Recipe data, or Index. The Control Variable offers a means of controlling and monitoring recipes.

Once a data field identified as a recipe type has been added to a project page, you can work with other recipe commands.

## **7.8.4 Configuring Recipe Parameter Sets**

A recipe is associated with a particular page and is composed of all the recipe data fields on that page. However, there can be a number of different parameter sets for a recipe.

A parameter set is a specific block of data within a recipe. A recipe parameter set is created by assigning particular values to the recipe data fields on a page. With Designer, it is



possible to create many different parameter sets within a single recipe. Depending upon the panel model, there can be up to 1024 parameter sets of a single recipe. Not only is a block of memory in the panel reserved for every recipe; separate blocks of memory are also reserved for each of the parameter sets contained within a particular recipe. All the parameter sets of a particular recipe always contain the same recipe data items but the values of these recipe data items vary between the different parameter sets.

These different recipe parameter sets can control different processes. One set may be used to configure the controller to control the production of 2 mm screws, another set may be used to configure the controller to control the production of 5 mm screws, and yet another to control the production of 7 mm screws. Each set of parameters is stored in a different parameter set within the same recipe.

You can specify the number of parameter sets to be contained within a recipe, as well as assign the initial values to the different parameter sets of a recipe. From the Page menu select Recipe Configuration. This brings up the Recipe Configure dialog box where initial values may be entered for recipe data items. These initial values will be in the format that was specified for that data field in the Data Field Properties dialog box. For example, if a numerical format of hexadecimal was entered in the Data Field Properties dialog box for a recipe data item, then all the subsequent values entered in the Recipe Configuration dialog box for this recipe data item will also be in hexadecimal. If you specify a numeric data format of hexadecimal for a recipe data item, and then enter a value of 10 in the Recipe Configuration dialog box, the 10 will be interpreted as 10 hexadecimal (base 16).

Note: Recipe data items must be defined on the current page before the Recipe Configuration dialog box can be activated. To do so, insert a Numeric/ASCII, Bargraph, or Message data field and select Recipe as the Reference.

Note: The recipe values section is in the form of a spreadsheet. Each row is associated with a particular recipe data field. The controller address of the recipe data item is displayed at the far left hand side of the row, enabling you to tell which row is associated with which recipe data item. Each column is associated with a particular parameter set of the recipe. Each parameter set is identified by a number. The first column corresponds to parameter set 1, the second column to parameter set 2, and so on.

### **7.8.5 Recipes and Control Variables**

### **7.8.6 Recipes and Control Variables**

Control variables offer a means of controlling and monitoring the Recipes. Control variables are special data fields that are stored in the UniOP panel memory. You can control certain operations of the panel by modifying the values held in these internal variables.

There are six types of control variables that affect recipes: Recipe File Status, Recipe Parameter Set Selection, Recipe Action, Data Entry Status, Data Entry Field Number, Recipe Page for Selection, and Recipe Key.

Control variables can be added to the project in the same way as other data fields. Control variable data fields can be added to a page from the Data Fields submenu under the Insert menu. From the Data Fields submenu, select either Numeric/ASCII, Bargraph, or Message. In the Properties dialog box, set the Reference type as Variable. Click the "..." button to set

the reference location, data type and format, page number, etc. in the Data Field Properties dialog box.

### 7.8.7 Recipe File Status

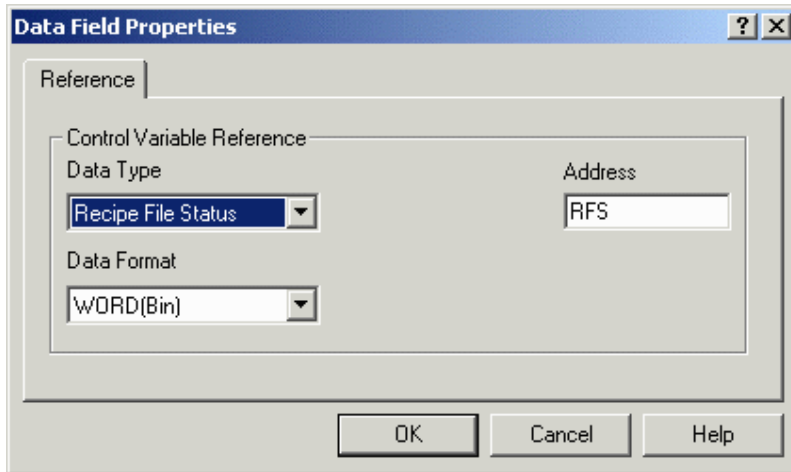

In the UniOP panel memory there is a single memory location that is used to store the status of the entire recipe data in the panel. This memory location is called the Recipe File Status.

The Recipe File Status cannot be modified by the panel's user; it is controlled by the internal logic in the panel.

The Recipe File Status can take on only 2 values, 0 or 1. A value of 0 indicates that all of the recipe data for every page in the project is valid. A value of 1 indicates that an error in some part of the recipe data was found. This means that the integrity of the recipe data is compromised. It is very rare for this to happen, but it can feasibly occur if the UniOP panel is powered off while the user is modifying the value of a recipe data field.

If the Recipe File Status has a value of 1, the panel's user must physically change the value of one of the recipe data items to reset the Recipe File Status to 0. Until this occurs, the user will not be able to perform recipe transfers.

### 7.8.8 Recipe Parameter Set Selection

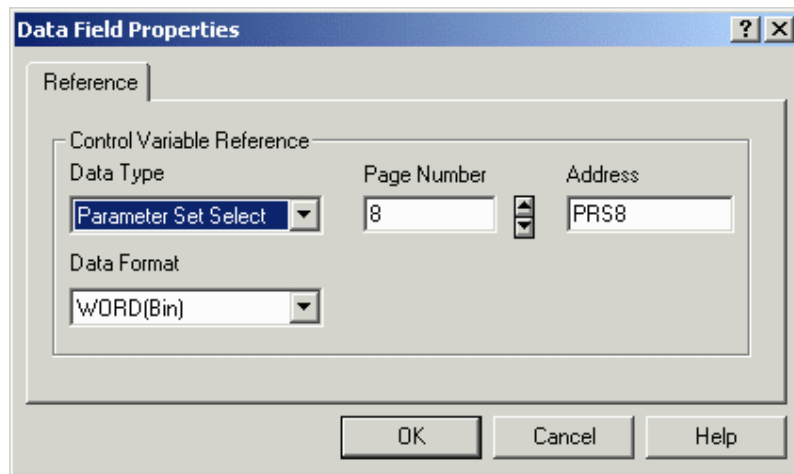

The UniOP panel reserves a separate memory location for the Recipe Parameter Set Selection for each recipe page. The Recipe Parameter Set Selection memory location stores the numeric identifier of the currently selected recipe parameter set for the recipe page.

Recipe Parameter Set Selection data fields can be used to visually display the currently selected recipe parameter sets of the various recipes in the project. When these data fields are added to a project, they must specify which recipe is to be monitored by the data fields. This is done by specifying the page number that contains the required recipe in the Data Field Properties dialog box.

For example, a project might contain three recipes, one on page 2, one on page 3 and the other on page 7. To monitor the currently selected recipe parameter sets of these three different recipes, three Recipe Parameter Set Selection data fields must be added to the project. One of these data fields will be used to monitor the recipe on page 2, one to monitor the recipe on page 3 and the third to monitor the recipe on page 7. These three Recipe Parameter Set Selection data fields could all be placed on any page of the project. Regardless of where they are placed in the project, the address of the first data field would be Recipe Parameter Set Selection 2, the address of the second data field would be Recipe Parameter Set Selection 3 and the address of the third data field would be Recipe Parameter Set Selection 7.

You can also change the parameter set of a recipe on a particular page by modifying the value held in the Recipe Parameter Set Selection variable. This is done in the same way as changing the value of a normal controller data field. For example, to make recipe parameter set number 3 the current parameter set, enter a value of 3 in the appropriate Recipe Parameter Set Selection variable. In order to do this, the Recipe Parameter Set Selection variable must be set as a Read/Write variable on the Range tab of the Properties dialog box under Insert - Data Fields - Numeric/ASCII, Bargraph, or Message.

### 7.8.9 Recipe Action

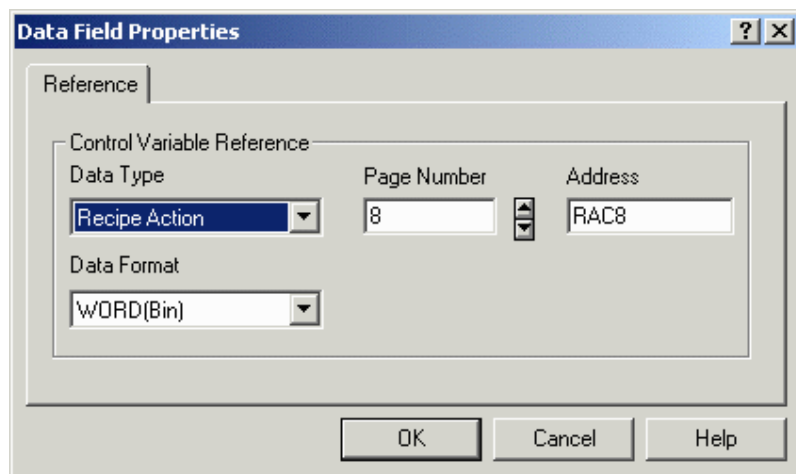

For each page that contains a recipe, the UniOP panel reserves a separate memory location for the Recipe Action for that recipe page. The Recipe Action memory location stores the current status of operation of the recipe for the page.

Recipe Action data fields can be added to the project. These data items can then be used to visually display the current state of the various recipes in the project. When these data items are added to the project, they must specify which recipe is to be monitored by the data item. This is done by specifying the page number that contains the required recipe in the Data Field Properties dialog box.

A Recipe Action data field can take on only 3 values: 0, 1 or 2.

A value of 0 indicates that the recipe is in its normal state of operation. In this mode of operation, the values of the recipe data fields are displayed on the screen of the panel and the values of the recipe data fields can be modified.

A value of 1 indicates that the recipe data for the currently selected parameter set is being transferred to the controller. When the transfer is complete the value is automatically reset to 0.

A value of 2 indicates that the recipe data for the currently selected parameter set is being transferred to the panel. When the transfer is complete the value is automatically reset to 0.

You can start a recipe transfer by entering a value of 1 or 2 for the Recipe Action data item. By entering a value of 1, you can force the UniOP panel to send the recipe data for the currently selected parameter set to the controller. By entering a value of 2, you can force the controller to transfer the recipe data for the currently selected parameter set to the panel.

### 7.8.10 Data Entry Status

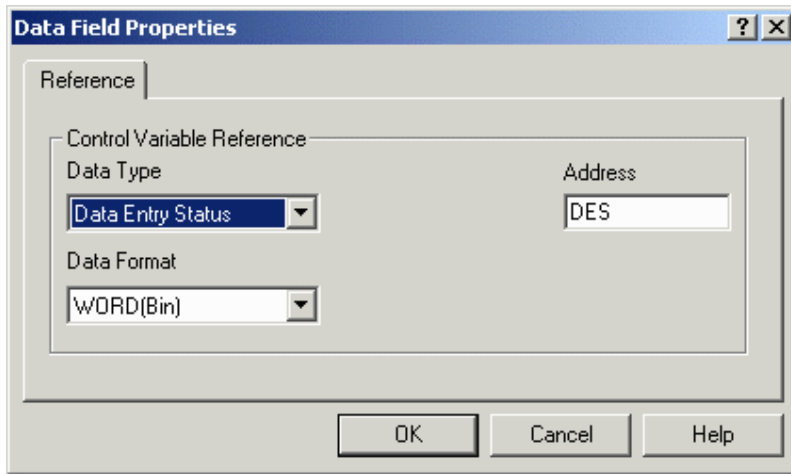

This control variable will be set to a 1 while the UniOP panel is in Data Entry Mode. In all other modes it will be set to 0.

### 7.8.11 Data Entry Field Number

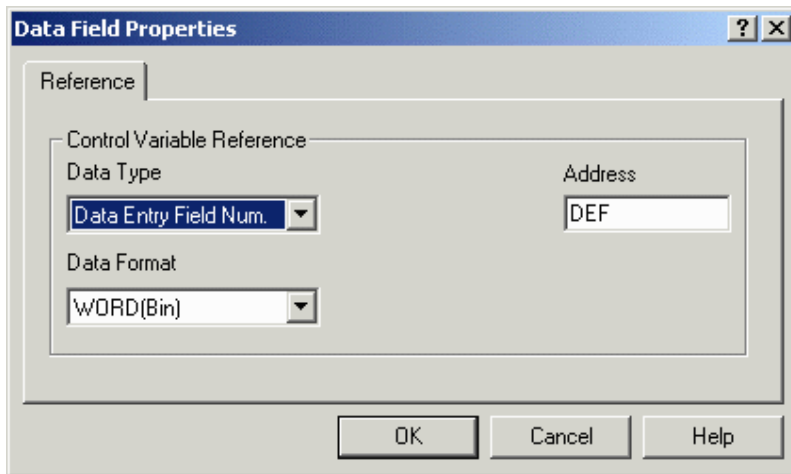

This control variable simply contains the field number of the selected data entry field whenever the panel is in Data Entry Mode.

### 7.8.12 Recipe Page for Selection

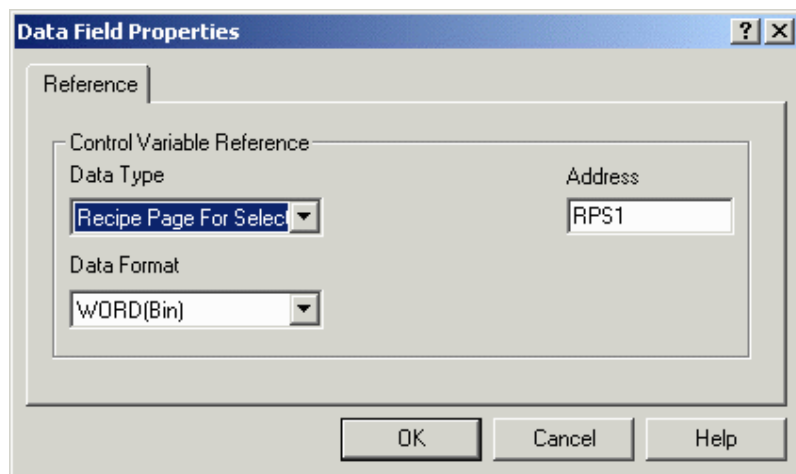

The purpose of the Recipe Page For Selection field is to show the number of the page containing the actual recipe data referred to by the Recipe Menu.

It can be placed on the same page with a Recipe Menu field to show the recipe page number. It can also be edited to change the page for which the Recipe Menu displays information. If the Recipe Page For Selection contains the page number of a page without a defined Recipe Name field, the Recipe Menu field will display asterisks ("\*\*"). After powering up the UniOP, the Recipe Page For Selection is set to zero.

### 7.8.13 Recipe Key

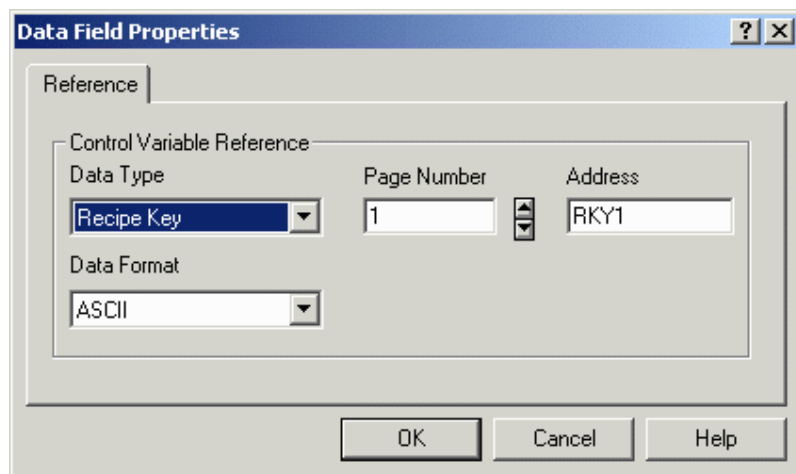

The Recipe Key field is an ASCII field, and is only available under Insert - Data Fields - Numeric/ASCII when ASCII is chosen as the Style. The Recipe Key field displays the currently selected Recipe Parameter Set name for the referred page.

Note: The page to which a Recipe Key field refers in the Data Field Properties dialog box must have a defined Recipe Name field. This is done by adding a Recipe data field with an ASCII display format on the page where the recipe is located and filling the Recipe Item values in the Recipe Configuration box with an ASCII name for each parameter set. This

ASCII field is called a Recipe Name field. If the referred page has no Recipe Name field defined, the Recipe Key field will display asterisks ("\*\*").

### **7.8.14 Recipes and the Keyboard Macro Editor**

The Keyboard Macro Editor provides a way to configure panel keys to perform recipe functions. When doing so, use Page n mode (where n is the page on which the recipe of interest is located).

Keyboard Macro Editor commands that pertain to recipes include:

Recipe Control - can be used to download, upload, or select a parameter set.

Go to Recipe Menu - can be used to jump to a page with a Recipe Menu.

Scroll Recipe Menu - can be used to scroll to a selection in the Recipe Menu.

Confirm Recipe Menu Selection - can be used to accept the selected parameter set name.

Recipes and Events Backup - can be used to back up recipe data, as well as the event list, into flash memory inside the panel.

Step Control Variables - can be used to assign a key or touch cell to toggle through the different parameter sets.

### **7.8.15 Recipe Menu**

### **7.8.16 Recipe Menu**

The Recipe Menu is a feature that simplifies recipe parameter set selection on UniOP panels through a user-friendly interface. It provides a menu-like field that can contain names to describe the parameter set instead of using numbers. Each name represents one recipe parameter set.

Note: A Recipe Name field must be defined to enable Recipe Menu support.

Recipe Names

Recipe Menu Support Fields

Creating a Recipe Menu Field

Recipe Menu Keyboard Macros

### 7.8.17 Recipe Names

### 7.8.18 Recipe Names

A Recipe Name should be defined for all of the pages containing recipes that are going to be handled using the Recipe Menu, and also for pages that are referred to by Recipe Key fields.

This is done by adding a Numeric/ASCII data field with an ASCII display style and Recipe type Reference on the page where the recipe is located and filling the Recipe Item values in the Recipe Configuration box with an ASCII name for each parameter set.

This ASCII field is called a "Recipe Name" field. (This field is not a field type name; it only describes the field's purpose.) If the referred page has no Recipe Name field defined, the Recipe Key field will display asterisks ("\*\*").

Note: This ASCII field is not an internal variable in the panel memory. It needs to be addressed to a physical location in the PLC memory. The amount of memory required depends on the length of the ASCII string: one byte per character.

A Recipe Name Example is provided.

### 7.8.19 Recipe Name Example

This example of creating a Recipe Name assumes that the current page is the page with defined recipes and that it is the page for which you want to add a Recipe Name.

Create a new project file by selecting New from the File menu, or by clicking on the New icon on the toolbar. Name the new file and click OK.

Insert an ASCII data field by selecting Insert - Data Fields - Numeric/ASCII, or clicking on the Numeric Field icon on the toolbar.

Use the cursor crosshairs to define a data box on the page.

Select the data field style as ASCII, and set the Reference to be Recipe.

Click on the "..." button to set the Reference value. Verify the Data Field Properties settings, or change if necessary. Click OK.

Click on the Range tab. Select Read/Write to make recipe names editable.

Click OK. A data field placeholder will appear using "R" as a placeholder for the actual recipe values.

From the Page menu choose Recipe Configuration.

Set the Number of Parameter Sets as appropriate. (For example, set to 4 to define four recipe parameter sets if you also plan to also enter four numeric style recipe data fields on the page.)



Find the Recipe Item with the location of the Recipe Name field. (This will normally be the row with empty boxes.) Fill in the boxes in the row for that Recipe Item with ASCII names for the recipe parameter set.

Select this Recipe Item by clicking on the button with the record number. The entire row highlights to indicate that it is selected.

Click on the Set As Recipe name button to set this Recipe Item to be the Recipe Name. An asterisk ("\*") appears to the right of the Recipe Item to identify it as the Recipe Name.

Click on the OK button to accept the changes.

### **7.8.20 Recipe Menu Support Fields**

There are three specific fields that support the Recipe Menu. They are the:

Recipe Menu field,

Recipe Page For Selection field, and

Recipe Key field.

The Recipe Menu field is the actual field that displays the menu with recipe names. The currently selected recipe parameter set is indicated using user defined attribute combinations (blink, highlight, reverse).

The Recipe Page For Selection field shows the number of the page containing the actual recipe data referred to by the Recipe Menu.

The Recipe Key field is not directly connected with Recipe Menus. It is a less user-friendly way of selecting a recipe parameter set by name. In order to choose a recipe parameter set, you have to edit the field and type the desired recipe name (instead of being able to select it from a menu). It can also be used to show the currently selected Recipe Parameter Set name for a specific page. The Recipe Key field must refer to a specific page with a defined Recipe Name.

These fields do not depend on each other and can be freely put on any page in the project in any combination.

### **7.8.21 Creating a Recipe Menu Field**

### **7.8.22 Creating a Recipe Menu Field**

The Recipe Menu field is the field that displays the menu with the parameter set names. It displays recipe names for the page number specified by the Recipe Page For Selection internal UniOP variable. The value of this variable can be displayed and changed using the Recipe Page For Selection field. Its value can be automatically set by the Go To Recipe Menu macro command.

The currently selected recipe name is indicated with a user-defined attribute combination (blink, highlight, reverse).

Note: A Recipe Name field must be defined to enable Recipe Menu support.

Note: The only field on the page needed for displaying a Recipe Menu is the Recipe Menu field. Other fields can show additional information but are not necessary.

Note: If Recipe Page For Selection contains the page number of a page without a Recipe Name field defined, the Recipe Menu field will display asterisks ("\*\*").

A Recipe Menu example is provided.

### 7.8.23 Recipe Menu Example

The following procedure describes how to add a Recipe Menu field.

Create a new project file by selecting New from the File menu, or by clicking on the New icon on the toolbar. Name the new file and click OK.

Insert a numeric data field by selecting Insert - Data Fields - Numeric/ASCII, or clicking on the Numeric/ASCII icon on the toolbar.

Use the cursor crosshairs to define a data box on the page.

Select the data field style as Numeric, and set the Reference to be Recipe.

Click on the "..." button to set the Reference value. Verify the Data Field Properties settings, or change if necessary. Click OK.

Click OK again. A data field placeholder will appear using "R" as a placeholder for the actual recipe values.

Select Insert - Recipe Menu, or click on the Recipe Menu icon on the toolbar.

Use the cursor crosshairs to define a box on the page. This area will contain the Recipe Menu field.

The Recipe Menu dialog box appears.

Adjust the Width and Height of the Recipe Menu field if necessary.

Choose the attribute combination (blink, highlight, and/or reverse) for indicating the selected recipe name.

Check Show Record Numbers if you want to show the record number (which is just the parameter set number) along with the recipe name.

Click on the OK button.

### **7.8.24 Recipe Menu Keyboard Macros**

Three special keyboard macros support Recipe Menus. They are:

Go to Recipe Menu - can be used to jump to a page with a Recipe Menu.

Scroll Recipe Menu - can be used to scroll to a selection in the Recipe Menu.

Confirm Recipe Menu Selection - can be used to accept the selected parameter set name.

### **7.8.25 Recipes and the Interlock Mailbox**

The Interlock Mailbox offers a powerful way to control the operation of recipes from the controller. There are seven mailbox commands available to function with recipes:

Start Recipe Download

Start Recipe Upload

Recipe Status

Get Parameter Set Number

Set Parameter Set Number

Get Recipe Transfer Priority

Set Recipe Transfer Priority

The mailbox commands allow the choice of the recipe page and also of the parameter set. All mailbox commands related to recipes return a completion code describing the results of the operation. The mailbox interface to recipes is particularly useful if it is necessary to transfer a sequence of recipes to and/or from the panel.

### **7.8.26 Multipage Recipe Support**

#### **7.8.27 Multipage Recipe Support**

Data which are logically part of a single recipe can be scattered over several project pages and still be selected, downloaded or uploaded with a single command. A recipe spanning several pages is called "Multipage Recipe".

Note: Multipage recipes are supported by UniOP firmware versions 4.20 and later.

Multipage Organization

Multipage Configuration

Recipe Menu for Multipage Recipes

### 7.8.28 Multipage Organization

You can define one multipage recipe and as many standard, single-page recipes as you wish per project. The multipage recipe can contain any number of pages, even all the pages in the project.

### 7.8.29 Multipage Configuration

To enable the Multipage recipe feature in the Designer software, define the desired number of single page recipes in your project and for each of these pages check the Multipage recipe checkbox in the Recipe Configuration dialog box.

Marking the checkboxes links all multipage recipe pages together and any recipe-related action (parameter set selection, upload and download) done in run-time (i.e., on the UniOP panel) on any linked page will result in the same action being done for all the pages. In other words, parameter set selection, upload, and download process can be done by referring to any page contained in the multipage recipe.

The Multipage recipe checkbox must be checked for all pages belonging to the multipage recipe. For any recipe page not contained in the multipage recipe, simply leave the checkbox unchecked, as it is by default.

The recipe name should be defined in only one page of the multipage recipe. If you want to display names in the recipe menu for the multipage recipe, the Recipe Page for Selection field must refer to the page that contains the ASCII field declared as the Recipe Name.

Note: The definition of parameter set numbers and values for a multipage recipe is still done one page at a time, as it is for standard, single-page recipes.

Note: An equal number of parameter sets in all pages belonging to the multipage recipe should be defined, otherwise recipe upload and/or download may be aborted in the middle. In addition, make sure that the variables on the pages of a multipage recipe are different. Otherwise, you could have problems in data integrity during download and upload operations.

### 7.8.30 Recipe Menu for Multipage Recipes

Recipe Menu features are enabled on multipage recipes in the same way as single page recipes.

Make sure that the recipe name is defined in only one page of the multipage recipe. If you want to display names in the recipe menu for the multipage recipe the Recipe Page for Selection field must refer to the page that contains the ASCII field declared as the Recipe Name.

## 7.8.31 Recipes and Events Backup in Flash

### 7.8.32 Recipes and Event Backup in Flash

On some of the UniOP panels, it is now possible to back up recipe data, as well as the event list, into flash memory inside the UniOP. This means that even the UniOP loses power AND the backup battery is discharged or missing, the recipe data and the event list will be preserved.

To use this feature, select the two checkboxes entitled Recipe Backup and Events Backup by selecting Project – Panel Setup and clicking on the Settings index tab. Please note that selecting these features uses memory within the UniOP that is normally reserved for the project file. Therefore, the amount of memory available for the project file is reduced by the amount of memory reserved for the entire backup of both recipe data and the event list, which is 128 KB.

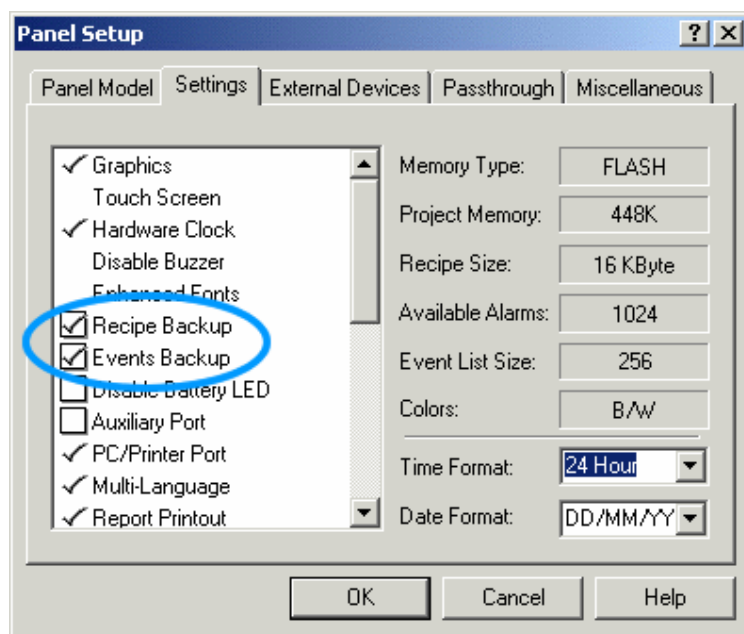

#### Panel Startup Sequence

With this feature enabled, the following sequence is performed on power-up of the UniOP:

Check the data inside RAM. If the data is valid, it will be used.

If the data inside RAM is invalid, the data in flash memory is checked. If the data inside the flash memory is valid, it will be used.

If the data in the flash memory is not valid, the recipe memory and the event list will be initialized with no data.

#### Recipes and Events Run-Time Backup

### 7.8.33 Recipes and Events Run-time Backup

Recipes and Events backup implementation is slightly different depending on the UniOP Firmware version.

Using UniOP Firmware version V4.40, when this feature is enabled, recipes are copied to flash memory automatically from the UniOP after any recipe field modification or after any controller recipe upload operation. The event list is copied to flash memory any time one event happens. A new macro command can be used to perform a manual backup operation.

Using UniOP Firmware version V4.44 or higher, the memory backup is activated only by the manual of the corresponding macro command or after any controller recipe upload operation (recipe field modification on panel doesn't force an automatically recipe backup to flash memory).

If the Recipes&Events backup flags in Panel Setup are disabled, the macro command does not have any effect.

If the flags are enabled, the data backup is performed.

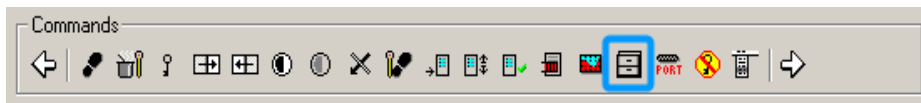

For the duration of the write operation to the Flash memory the panel LED #65 will be on to indicate that a write operation is in progress. Some UniOP models do not have this LED. For those UniOP panels that do not have this LED, the control variable Recipe/Event Backup can be used to give feedback to the operator on the status of the backup operation. This control variable takes the values listed below.

Recipe/Event Backup:

- 0 = Standby
- 1 = Backup operation in progress

The S12 bit of the RDA area is used to inform the controller that a backup operation to Flash memory is in progress. The UniOP will set this bit to 1 just before the backup operation begins. When the backup operation is complete, UniOP will reset the bit to 0.

Note: When UniOP goes from Configuration Mode to Operation Mode, the content of the Event List stored in RAM is erased. Using the “Events Run-time Backup” feature when UniOP goes back to Operation Mode if a valid list is stored in Flash, this is retrieved and copied to RAM; if the Flash memory does not contain any valid data, the Event list will be empty.

The use of the “Clear Event List” macro commands erases the content of the Event list stored in RAM and in Flash memory.

## 7.8.34 Recipe Example

### 7.8.35 Recipe Examples

Two examples are provided to experiment with recipes. One is a straightforward example of defining and downloading a simple recipe, while the other uses a more complex configuration.

### 7.8.36 Simple Recipe Example

It is not necessary to create a complex project to try recipes. This example will illustrate how to define a very simple recipe.

Make sure that the panel is in Configuration Mode.

Connect the panel to the PC and the controller using the correct cables.

Start the Designer software.

Create a new project file by selecting New from the File menu, or by clicking on the New icon on the toolbar. Name the new file and click OK.

Click on the page and insert text (PLC Data, Recipe, Temperature and Pressure) to resemble the figure below.

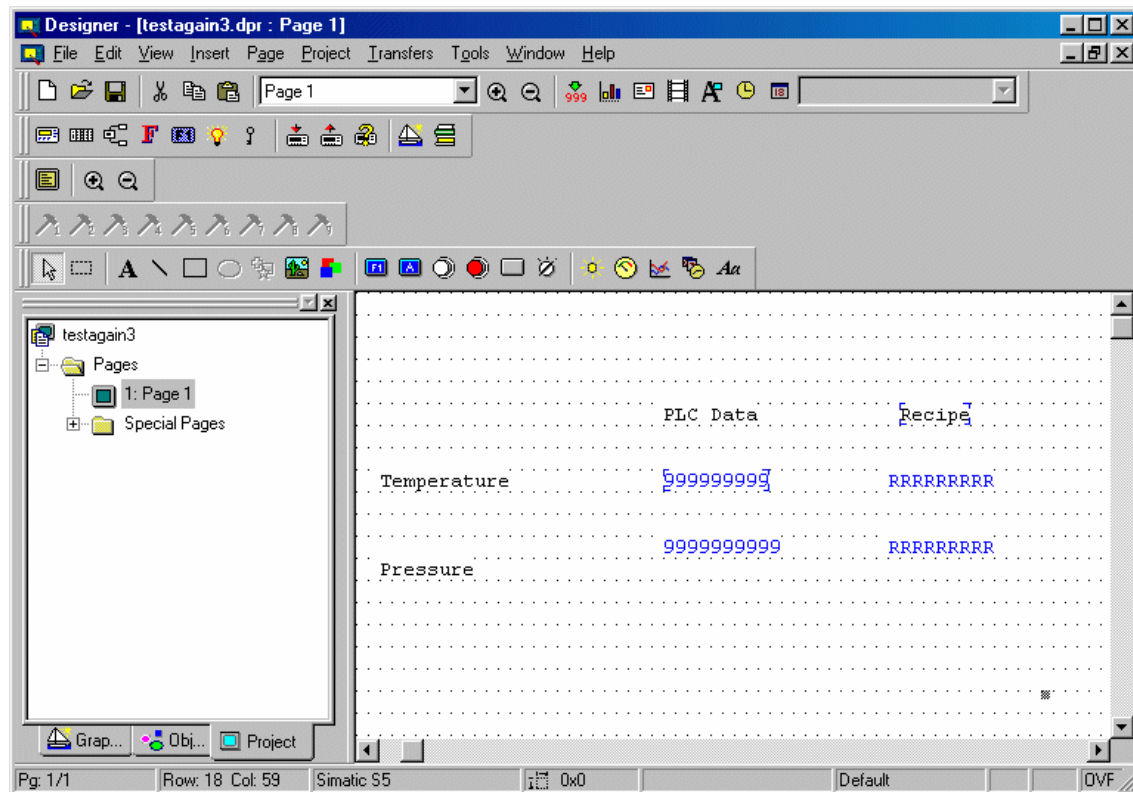

Select Insert - Data Fields - Numeric/ASCII, or click on the Numeric Field icon on the toolbar.

Use the cursor crosshairs to define a data box under "PLC Data" for "Temperature".

Select the data field style as Numeric, and set the Reference to be PLC.

Click on the "..." button to set the Reference value. Verify the Data Field Properties settings, or change if necessary. Click OK.

Click OK again. A numeric data field placeholder will appear using "9" as a placeholder for the actual numeric values.

Repeat steps 6 through 10 for "Pressure" under "PLC Data".

Select Insert - Data Fields - Numeric/ASCII, or click on the Numeric Field icon on the toolbar.

Use the cursor crosshairs to define a data box under "Recipe" for "Temperature".

Select the data field style as Numeric, and set the Reference to be Recipe.

Click on the "..." button to set the Reference value. Verify the Data Field Properties settings, or change if necessary. Click OK.

Click OK again. A recipe data field placeholder will appear using "R" as a placeholder for the actual recipe values.

Select Recipe Menu from the Insert menu and click OK.

Select the option Recipe Configuration from the Page menu. This will bring up the dialog box shown in below.



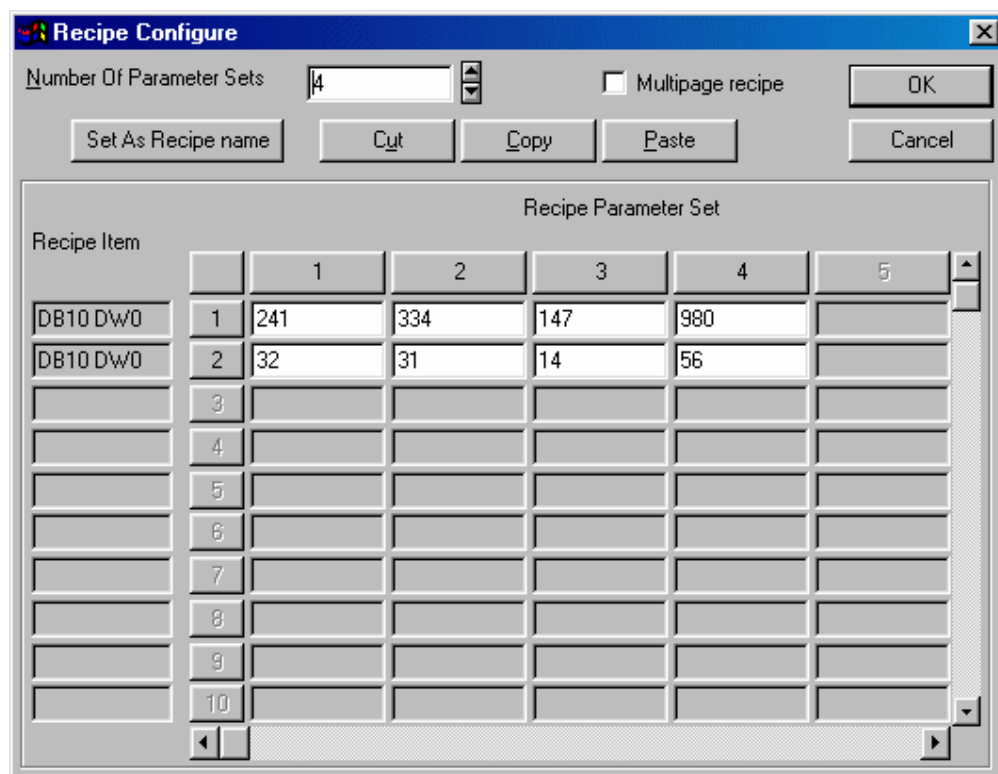

Enter 4 for the Number of Parameter Sets.

Enter the recipe values as shown above. Note that the Recipe Item addresses are the reference addresses of the fields that were defined earlier.

Click OK to confirm the operation.

From the Project menu select the Keyboard Macro Editor.

On the Page 1 tab, click on F1. It will display a different color from the other keys to show that it is selected.

For Key States select Pressed.

From the Commands bar select the command Recipe Control. (Click the arrow to view additional commands if this command is not visible on the command bar.)

In the Recipe Upload / Download / Select parameter set dialog box, click Download. For Parameter set insert 1.

Repeat steps 24 and 25 for Parameter sets 2, 3, and 4.

Click OK.

Download the project to the panel by pressing the F2 key on the computer keyboard, by selecting the Download icon on the toolbar, or by choosing Download from the Transfers menu.

When the download is finished, the panel will go into Operation Mode. The variables in the left column represent the content of the controller memory. The column on the right will represent the content of the first recipe parameter set once the F1 key is pressed.

Press the F1 key to make the panel start downloading the current recipe parameter set (which is parameter set 1). After a few seconds, the operation will be completed and the content of the controller memory will show the same values as those that are stored in parameter set 1.

### **7.8.37 Complex Recipe Example**

Create a new project file by selecting New from the File menu, or by clicking on the New icon on the toolbar. Name the new file and click OK.

Insert a numeric data field by selecting Insert - Data Fields - Numeric/ASCII, or clicking on the Numeric Field icon on the toolbar.

Use the cursor crosshairs to define a data box on the page.

Select the data field style as Numeric, and set the Reference to be Recipe.

Click on the "..." button to set the Reference value. Verify the Data Field Properties settings, or change if necessary. Click OK.

Click OK again. A data field placeholder will appear using "R" as a placeholder for the actual recipe values.

Insert an ASCII data field by selecting Insert - Data Fields - Numeric/ASCII, or clicking on the Numeric Field icon on the toolbar.

Use the cursor crosshairs to define a data box on the page.

Select the data field style as ASCII, and set the Reference to be Recipe.

Click on the "..." button to set the Reference value. Verify the Data Field Properties settings, or change if necessary. Click OK.

Click on the Range tab. Select Read/Write to make recipe names editable.

Click OK. A data field placeholder will appear using "R" as a placeholder for the actual recipe values.

From the Page menu choose Recipe Configuration.

Set the Number of Parameter Sets to 4 to define four recipe parameter sets.

Enter parameter set values as shown below.

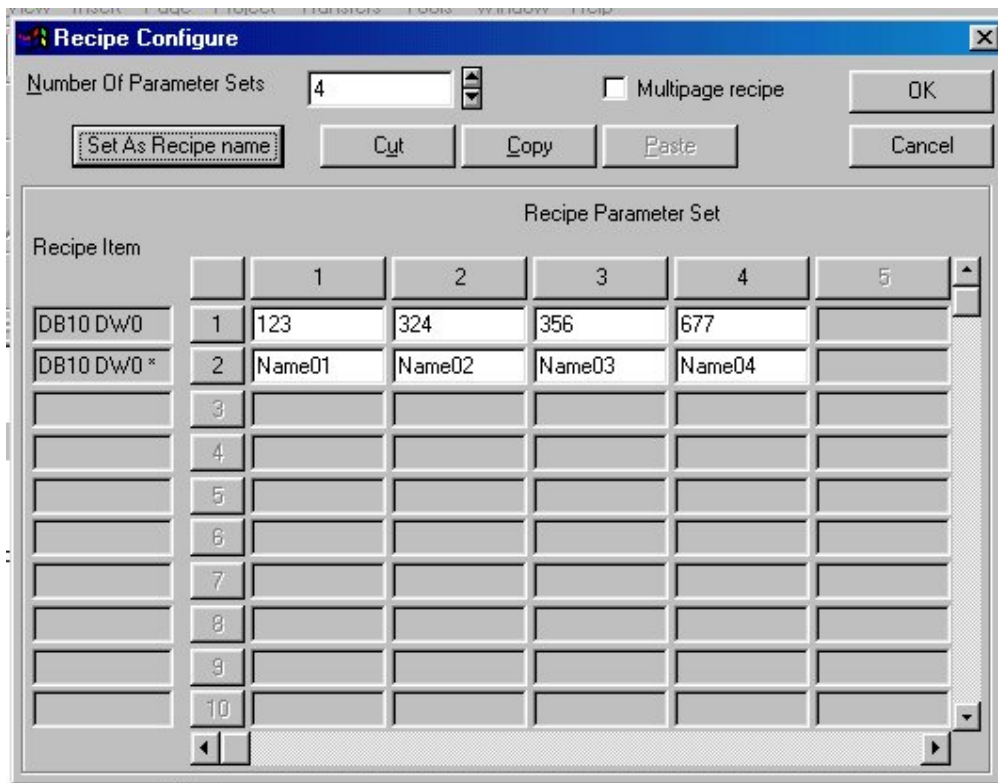

Select the Recipe Item for the second row by clicking on the button with the record number 2. The entire row highlights to indicate that it is selected.

Click on the Set As Recipe name button to set this Recipe Item to be the Recipe Name. An asterisk ("\*") appears to the right of the Recipe Item to identify it as the Recipe Name.

Click on the OK button to accept the changes.

Select Insert Page from the Page menu.

From the new page, select Insert - Recipe Menu, or click on the Recipe Menu icon on the toolbar.

Use the cursor crosshairs to define a box on the page. This area will contain the Recipe Menu field.

The Recipe Menu dialog box appears.

Adjust the Width and Height of the Recipe Menu field if necessary.

Choose the attribute combination (blink, highlight, and/or reverse) for indicating the selected recipe name.

Check Show Record Numbers if you want to show the record number (which is just the parameter set number) along with the recipe name.

Click on the OK button.

Select Project - Keyboard Macro Editor, or click on the Keyboard Macro Editor icon.

From the Page 1 tab select the command Scroll recipe menu.

Specify the step size as 1 in the Scroll recipe menu dialog box.

Select the command Confirm recipe menu selection.

Click OK.

Go back to Page 2 (the first page that you created).

From Page 2, select Project - Keyboard Macro Editor, or click on the Keyboard Macro Editor icon.

Repeat steps 32 and 33 for Parameter sets 2, 3, and 4.

Click OK.

Make sure that the panel is in Configuration Mode.

Download the project to the panel by pressing the F2 key on the computer keyboard, by selecting the Download icon on the toolbar, or by choosing Download from the Transfers menu.

When the download is finished, the panel will go into Operation Mode. The variables represent the content of the first recipe parameter set once the F1 key is pressed.

Press the F1 key to make the panel start downloading the current recipe parameter set (which is parameter set 1). After a few seconds, the operation will be completed and the content of the controller memory will show the same values as those that are stored in parameter set 1.

## 7.9 Tags

### 7.9.1 Tags

Tags allow mnemonic reference to PLC variables. Tags in a project can be imported from a description file generated outside Designer.

To use tags, the Enable Tags box must be checked under Project - Configure Tag Dictionaries.

Once enabled, you can select a tag name instead of filling in the PLC address for a field in the project. When a tag name is selected, the PLC Reference information will be automatically filled in with the reference information associated with the tag name.

Discussions about tag dictionaries, using the Tag Editor, using tags in Designer, and tag validation are provided, as is a tag example.

Note: When a tag name is selected, the PLC Reference information will be filled in with the reference information from the tag and the PLC Reference dialog controls will be disabled. You will only be able to change tag information from the Tag Editor in the Tools menu.

Note: Tag support is available for internal controllers as selected under Project - Configure Controller. Tag definition for an external controller is allowed only if the external PLC supports tag definitions. Please refer to EXOR Technical Documentation for further information about drivers that support tag definition.

## 7.9.2 Tag Dictionaries

## 7.9.3 Tag Dictionaries

A tag dictionary is a database of file format \*.mdb. These databases may be imported to or exported from Designer.

The file to be used as the project tag dictionary is set under Project - Configure Tag Dictionaries. (This is also where you can set the Enable Tags checkbox.) Click on the "..." button to select the location of the tag database file of choice. Tag dictionaries are tied to controller brands and models. If you do not have a tag dictionary, the Tag Editor in the Tools menu allows you to create one.

A tag dictionary is associated with each project and defines the model and attributes of the PLC. You can select a dictionary for your project when you enable the tag feature in the project for the first time.

You can create multiple tag dictionaries inside a tag database and add tags to each dictionary. Each dictionary is configured for a specific PLC controller and model name. Each project is assigned to a dictionary.

You can create multiple dictionaries in a database in order to support a project that has a PLC Network and/or UniNET Network. To be able to use tags for a project that supports the UniNET/PLC Network, at least one dictionary must exist in the database for each of the nodes in the network.

Note: If a project supports a UniNET/PLC network, each UniNET node/ PLC Node must be tied to a tag Dictionary in the database. You will be required to assign a tag dictionary for all the nodes during the configuration of UniNET/PLC network. Each node must have at least one dictionary in the database. If PLC network is enabled and you change the PLC Node, the Tag Name controls will be initialized with the tags from the dictionary tied to the current PLC Node.

Additional information is available on:

Tags and the UniNET & PLC Networks

Multiple Project Support

## 7.9.4 Tags and the UniNET and PLC Networks

With the UniNET network and a PLC network, different PLC drivers can be assigned to different fields in the project. Because of this, Designer must support multiple tag dictionaries for a project. When assigning a tag name to a network field, Designer will query the tag

database for the tag dictionary associated with the network node's PLC driver. You will then be able to select the tag name from the list of tags in the associated tag dictionary.

Note: You will only be able to select a tag from a dictionary that is assigned to the given PLC node. This is necessary since the format of the address associated with a tag is dependent on the PLC.

### **7.9.5 Multiple Project Support**

Typically, one tag database file will be used for each Designer project. The tag database resides in the same directory as the project file. If you want to copy the project data, you must also copy the tag database with the project.

In some instances, however, you may want to create a tag database that contains tags for multiple projects. As a result, the tag database has been designed such that multiple projects can exist in the same database. For these situations, you can set the location of the tag database in Designer (if it is not in the same directory as the project file) and Designer will access only the tags that are associated with the active project.

### **7.9.6 Tag Editor**

### **7.9.7 Tag Editor**

Use the Tag Editor to create dictionaries and tags in databases that can be used in one or more projects. The Tag Editor allows you to easily work with a large number of tags by creating a tag database for your project. It provides the capability to add, delete and modify tags as well as assign PLC addresses to each tag, plus it includes import and export capabilities to exchange tags with external applications. You can create a list of tag names in the Tag Editor and then assign the tag names to various fields of the Designer project by simply selecting a tag name.

The Tag Editor uses a grid-like user interface. Features of the Tag Editor include:

Add, delete and edit tags.

Enter the name, address, data type and a comment for each tag.

Create one or more Tag Dictionaries for tags associated with a PLC.

Assign group names to tags.

Import and export tags to and from external data sources.

Cut/copy/paste tags using the Windows™ clipboard.

Drag and drop tags between the Tag Editor and other applications.

Import project-specific information using a network file and assign dictionaries to each node.

You can create a list of tag names in the Tag Editor and then assign the tag names to the fields of your project by simply selecting a tag name in the Data Field Properties dialog box.

Using the Tag Editor, you can assign a tag name to fields such as Numeric, Text, Alarm blocks, etc. When the Data Field Properties dialog box is displayed, a box is included listing the available tag names. You can select a tag name from the box and the field address will automatically be set to the PLC address associated with the tag.

When a tag is displayed in the Define Field dialog box, the tag data is retrieved from the tag database. As such, if you change the PLC reference for a tag in the Tag Editor, the PLC reference information displayed in the Define Field dialog box will be up to date.

You can also change the tag dictionary for the project. When the tag dictionary is changed, the address for the tags in the project will be automatically updated based on the new tag dictionary information.

Additional information is available on the following topics.

Tag Groups

Tag Editor Synchronization

Importing and Exporting Tags

### **7.9.8 Tag Groups**

A Group field is provided for categorizing tags. The group name is assigned when creating the tag and used to more easily manage large groups of tags. For example, you may want to group tags according to a PLC program. The program name can be inserted into the Group field and you will be able to sort tags by program name.

### **7.9.9 Tag Editor Synchronization**

At start up, after a project upload and before a project download, Designer will synchronize the project tag data with the tag database. To perform the synchronization, Designer will scan the fields of the project and verify that the tag addresses in the project file match the tag addresses in the tag database. If there are any differences between the project data and the tag database, a dialog box will be displayed. This dialog box will include a list of the tags that are different between the tag database and the project data and provide options to update the project data, update the tag database, or leave the tag information unchanged.

The tag data between Designer and the tag database is also synchronized when the Define Field dialog box is displayed. When the Define Field dialog box is displayed for fields that have tag names, the tag database will be queried to retrieve the field address information. The address information for the database is then updated in the field and displayed in the dialog box.

Using this approach, the latest information in the tag database will always be displayed in the Designer project.

### **7.9.10 Importing and Exporting Tags**

The Tag Editor provides the capability to import and export tags to and from external data sources. When the Import menu item is selected, an "Open File" type dialog box is displayed

and you can select the desired data source from which to import tags. After the tags are imported, the tag names and logical addresses are displayed in the Tag Editor grid. When the Export menu item is selected, a Save As dialog box is displayed and you can select the desired export format and enter the file name to which to export the tag data.

The Import and Export operations are dependent on the format of the data being imported or exported.

### **7.9.11 Using Tags in Designer**

Once you have a tags dictionary set up for a project, there are a few additional steps necessary to configure the project to work with the tags. The controller for the project (Project - Configure Controller) should be the same controller specified in the tag dictionary.

From the Project menu select Configure Tag Dictionaries. Click the Enable Tags box and select the tag database you created for this project.

Then, for any applicable field (Numeric/ASCII data field, meter instrument, etc.) click "..." under Reference to bring up the Data Field Properties dialog box. In the Data Field Properties box check Enable Tags and select the tag dictionary to be associated with the reference.

You may wish to use the Tag Validation feature in the Project menu before downloading the project.

### **7.9.12 Tag Validation**

### **7.9.13 Tag Validation**

Tag Validation allows you to switch from one tag dictionary, referring to one set of PLC addresses, to a different dictionary, referring to different set of PLC addresses in the same controller, and update all the fields in the project without needing to update the individual PLC addresses used in the whole project.

Also, you can switch from one tag dictionary, referring to Controller A to a different dictionary, referring to controller B and update all the fields in the project without updating the individual PLC addresses used in the whole project.

This feature can also validate the PLC addresses used in a project with respect to the PLC addresses used in the tag dictionary, and finds and lists any discrepancy items with all details such as location, etc.

This feature supports updating the tag database (with regard to PLC Address used in the project) and updating the project field (with regard to PLC Address used in the tag dictionary).

See also Changing PLC Drivers.



### 7.9.14 Changing PLC Drivers

A tag name represents an address for a particular PLC. As such, when the PLC Driver is changed in the project, the tag dictionary and the tag names must be invalidated. To minimize the impact of changing the PLC driver, Designer will attempt to match the tag names from the previous dictionary to the tag names in the new dictionary associated with the new PLC driver.

When the PLC Driver is changed, you will be required to assign a new tag dictionary for the new PLC driver. Designer will then iterate through the list of tags in the project and replace the field address associated with the tag with the address information found from the new dictionary. The field address associated with each tag will then be validated based on the new dictionary. If the tag name does not exist in the new dictionary, the address information for the tag will be set to a default address of the new PLC.

With this approach, it is possible to change from one PLC driver to another PLC driver without having to reset the tag name for each field, as long as the tag dictionaries for each driver contain the same tag names.

### 7.9.15 Tag Example

### 7.9.16 Tag Example

This tag example is composed of four parts:

Setting Up a Tag Dictionary

Configuring a Project to Use Tags

Tag Validation, and

Testing Tag Validation

### 7.9.17 Setting Up a Tag Dictionary

Note: If you already have a tag database and dictionary you may skip to step 4.

Select Tag Editor from the Tools menu. The Tag Editor application opens.

Select File - New from the Tag Editor to create a new tag database. Enter a name for the new database, specify its location, and click OK.

The database you just created appears in the Tag Editor workspace. Right-click on the new database and select New Dictionary, or select New Dictionary from the File menu.

Enter a name for the new tag dictionary in the Tag Dictionary box.

Select the controller driver to be used from the list under Controller Driver.

Select the particular model of that controller driver from the list under Driver Model.

Click OK.

The New group dialog box appears. Fill in the grid with tag names, comments, and any other necessary information.

To specify the logical addresses associated with the various tags, click on the Logical\_address box and an arrow appears. Click on the arrow to bring up a Data Field Properties dialog box. Complete this box for the particular reference address and click OK. The information appears in the Logical\_address box. The Data\_Format box will also be automatically completed.

When the grid is completed, select Save As from the File menu to save the dictionary.

Close the New group dialog box and select File - Exit to close the Tag Editor.

(Continued in Configuring a Project to Use Tags)

### **7.9.18 Configuring a Project to Use Tags**

(Continued from Setting Up a Tag Dictionary)

From the Project menu, select Configure Controller. Make sure that the controller specified for the project is the same as the controller specified for the tag dictionary. Click OK.

Select Configure Tag Dictionaries from the Project menu if the Change/Select Tag Dictionary dialog box does not automatically appear.

Click in the Enable Tags box.

Under Database click on the "..." button. Select the tag database you created and click Open.

Click OK to confirm the tags and controller information and close the Change/Select Tag Dictionary dialog box.

Create a field or object on the project page, such as a Numeric/ASCII data field, a push button, or a meter instrument.

Set the Reference as PLC and click the "..." button to bring up the Data Field Properties dialog box where you can specify the PLC address for the field or object as per the tags from the tag dictionary. Click the Enable Tag checkbox. (Note: If the Enable Tag checkbox does not appear in a Data Field Properties dialog box when you wish to use tags, start again from step 12 to ensure that the controller is properly set and that tags are enabled in the Tag Dictionary dialog box.)

Select the group and tag. To change any tag information, click on the Edit Tags button. Make the necessary changes and click OK to return to the Data Field Properties dialog box.

Click OK to close the Data Field Properties dialog box.

Click OK to close the field or object properties box.

Save the project by selecting Save from the File menu.

(Continued under Tag Validation)

### **7.9.19 Tag Validation**

(Continued from Configuring a Project to Use Tags)

Select Tag Validation from the Project menu.

If the data field PLC addresses in the project match the PLC addresses used in the dictionary, then the message "All the tags match with the field address values" will appear. Click OK. You may safely download your project.

(Continued under Testing Tag Validation)

### **7.9.20 Testing Tag Validation**

(Continued from Tag Validation)

If the data field PLC addresses in the project do not match the PLC addresses used in the dictionary, the tag validation dialog box appears with a list of the tags having a discrepancy.

To test this feature, simulate the following changes.

Select Project - Configure Tag Dictionaries. Click on the entry under Dictionary. A list of dictionaries will appear. Select a different dictionary. Click OK.

Select Project - Tag Validation. A list of address discrepancies appears.

To modify the PLC addresses, right click on an item. A menu appears allowing you to choose to update the field with database values, update the database with field values, or copy to a clipboard.

Select Update Field or Update Database, then click OK.

Select Project - Tag Validation again to verify that all tags match. Save the project and it may be safely downloaded.

## **7.10 Trends**

### **7.10.1 Trends**

Trending is divided into two main parts: trend acquisition and trend viewing. Trend acquisition (Project - Trend Buffers) collects the data into a database. The trend viewer (Insert - Trend Window) displays the data from this database in a graphical format.

Trend Buffer

Trend Window

Internal Panel Control Variables

Trend Macros

Trend Printing

Mailbox

Trend Limitations

### **7.10.2 Trend Buffer**

### **7.10.3 Trend Buffer**

The first step in creating a trend is to create a trend buffer.

For this, you need to define two items: the PLC variable that is to be sampled, and the method by which the variable is to be sampled.

The variable can be sampled from the UniOP panel or directly from the PLC. If the variable is sampled from the UniOP panel, all of the data from the trend buffer will be stored within the memory of the UniOP panel. If the variable is sampled directly from the PLC, the data from the trend buffer will be stored in the memory of the PLC. In the latter case, the only duty of the UniOP will be to graphically display the trend buffer data from the PLC.

Configuring a Trend Buffer

Sampling Methods

### **7.10.4 Configuring a Trend Buffer**

### **7.10.5 Configuring a Trend Buffer**

Trend buffers are configured under Project - Trend Buffers. Click the New (Insert) icon to define a new trend buffer name. Give the trend buffer a name, then select the Reference that is to be sampled.

To remove a previously defined trend buffer, select the name of the buffer from the trend buffer list and click the Delete icon.

Buffer Types

Scaling

### 7.10.6 Buffer Types

Under the General tab of the Configure Trend Buffers dialog box you should select the size (number of samples that will be kept during the background sampling) and type of buffer to be defined. Trends can be sampled in three different ways. The first option (All Pages) is to continuously sample the trend buffer, regardless of whether or not the trend associated with the trend buffer is being displayed. The second option (Current Page) is to sample the trend buffer only when the page where the trend associated with the trend buffer is being displayed. The third option (On Page) is to sample the trend buffer only when a particular page is being displayed.

Note: The number of trends that can be sampled in background is limited.

Note: When a trend is sampled in the background (All Pages), the sample size reflects the number of old samples that will be shown when the page that contains the trend associated with the trend buffer is displayed. When a trend is sampled in real time (Current Page), you will never see any old samples because sampling begins when the page that contains the trend is displayed. In this configuration the sample size is useful only when using the macros to scroll the trend along the X-axis. If these macros will not be used, you can save UniOP memory by setting the sample size to 1.

### 7.10.7 Scaling

Scaling allows for a linear transformation of the data being sampled. This allows you to scale the data before storing it inside the trend buffer.

### 7.10.8 Sampling Methods

The Sampling tab in the Configure Trend Buffers dialog box allows you to define when the trend samples will be taken, and the buffer is cleared.

Samples may be collected from the trend buffer stored inside the memory of the PLC, from the memory of the UniOP on a cyclical basis, or one a time, when a variable changes value. Or, data can be sampled only when the defined variable does not contain a value of zero.

Use the Stop Sampling checkbox to stop the sampling when the trend buffer is full. This is a first-in first-out (FIFO) buffer. Once the buffer is full, older sample values will be erased to allow the new sample values to be stored.

You can choose to clear the trend buffer upon panel startup, when the trend buffer becomes full, or when the selected variable changes value. You can also choose to never automatically clear the trend buffer. However if the Stop when buffer is full checkbox is not selected, the oldest sample is removed and the newest sample is stored when the buffer is filled.

## 7.10.9 Trend Window

### 7.10.10 Trend Window

The trend window is the area used to display the trend buffer. To create a trend window, select Insert - Trend Window or click on the Trend Window icon on the toolbar. Click and drag to define an area on the project screen. The Trend Window Properties dialog box will appear.

Note: A trend buffer must be defined under Project - Trend Buffers before you can access the Trend Window Properties dialog box. If a trend buffer has not already been established, you will be prompted to create one.

Y-Axis

X-Axis

Layout

### 7.10.11 Y-Axis

The Y-Axis index tab of the Trend Window Properties dialog box allows you to select the trend buffers (curves) to be displayed. Use the Add and Delete buttons to add or remove trend buffers.

For any curve, you can choose visualization properties such as line type, style, size and color.

Note: Once a curve is added to the trend viewer, you will only be able to add additional curves of the same sampling method to that particular trend window.

Designer creates three new variables for every curve defined. These variables are internal panel control variables that can be used to display properties of the trend on the UniOP in alphanumeric format.

The Y-cursor displays the value of the curve at a point on the Y-axis. Use the trend macros to activate the trend cursor.

The Y-axis minimum and Y-axis maximum variables contain the minimum and maximum values of the defined Y-axis. On the right of the dialog box, you can define the default value (Y-axis range) that will be used when the trend window is displayed. If these internal panel control variables are on the UniOP as read/write fields, their values can be modified on-line, allowing you to dynamically change the Y-axis range.

### 7.10.12 X-Axis

### 7.10.13 X-Axis

Under the X-Axis index tab you can define the X-axis properties of the trend window. The format of the X-Axis (Time, Samples or On PLC) is defined from the curves that are inside

the trend window. When no curves are defined, all of these radio buttons are disabled. After adding one or more curves, only the appropriate radio button is enabled.

Note: A single X-Axis exists for all of the curves that have been inserted inside the same trend viewer window.

The X-axis range can be defined three different ways.

Time defined - when the trend buffers inside the trend viewer are sampled cyclically from the UniOP.

Defined by a maximum number of samples - enabled when the trend buffers inside the trend viewer are sampled on PLC events.

Defined on the PLC - the number of samples must be defined inside the PLC memory.

Automatic scroll control is available so that a trend window can shift when it becomes full. How much the trend viewer will be shifted upon each scroll operation can be a fixed amount of time or a fixed number of samples. The scroll direction defines the direction of the curve. The curve can be drawn Left to Right, Right to Left, Up to Down or Down to Up.

The X-cursor displays the value of the curve at a point on the X-axis. Use the trend macros to activate the trend cursor.

The X-axis minimum and X-axis maximum variables contain the minimum and maximum values of the defined X-axis.

Trend Buffers on PLC

PLC Memory Area

### 7.10.14 Trend Buffers on PLC

Samples can be collected and stored inside the trend buffer of the UniOP panel or in the memory of the PLC. This section describes how to set up and organize trend buffers that are sampled inside the PLC.

Note: Trend buffers on PLC are available only on a few selected communication drivers. Please enquire for availability.

To enable a trend buffer in PLC memory, select the On PLC radio button on the X-Axis tab of the Trend Window Properties dialog box.

### 7.10.15 PLC Memory Area

To properly sample and store the data in the PLC, the trend buffer needs to be defined as a consecutive number of words with the following structure:

Word 00	Trend buffer identify (counter). Identification number of the trend buffer being displayed. The UniOP will erase its internal copy of samples when it detects a change in the value of this word.
---------	---

Word 01	Max number of samples (size of the trend window). Size of the trend window displayed on the UniOP as a number of samples. The uses this information each time a page of the project file is initialized.
Word 02	Number of samples available to be displayed in the PLC memory. Number of active samples inside the PLC memory. The UniOP will draw a trend based on the number of samples entered in this memory location. When this value is increased, a new piece of the trend will be drawn. Likewise, when this value is decreased, a portion of the trend will be removed. If you want to "freeze" the trend, enter a value of zero in this memory location. To erase the entire trend from the UniOP, this value must be set to zero AND the value of Word 00 must be changed.
Word 03	Sample #01
Word 04	Sample #02
Word 05	Sample #03
Word 06	Sample #04
Word nn	Sample #(nn-2)

The address of the first PLC word (Word 00) needs to be entered in the Reference field under Project - Configure Trend Buffers.

The settings to initialize the PLC operation mode are:

#### Initialization

Word 00	0
Word 01	<Buffer width in samples>
Word 02	0

#### Sampling (loop)

Word 03/nn	Add samples
Word 02	Update the number of ready samples

#### New trend

Word 02	Set to 0 to invalidate the PLC trend buffer (UniOP can continue to use and display the samples already displayed, but it cannot display new samples)
Word 03/nn	Add new samples
Word 00	+1 (UniOP detects this change and erases the trend)
Word 02	Update the number of ready samples



### **7.10.16 Layout**

From the Layout index tab of the Trend Window Properties dialog box you can define the main trend viewer properties such as the title, colors, border, grid, etc. Options in the Title section define the visual appearance of the trend viewer window title. Options in the Window section define the appearance of the trend viewer window.

### **7.10.17 Internal Panel Control Variables**

Internal panel control variables associated with trending can be defined and used from the trend viewer. Alphanumeric values of these variables can be displayed on the UniOP. To access these variables, it is necessary to switch Designer into Control Variables mode and create a numeric field. You will need to select a UniOP variable from Insert - Data Fields. The Variable name control will show the list of variables that have already been defined. The meaning of these variables can be found inside the trend window.

### **7.10.18 Trend Macros**

There are two icons in the Macro Editor (under Project - Keyboard Macro Editor) that are associated with trending.

The first macro, Trend buffer print, gives you the ability to print the trend buffer in alphanumeric format. The "buffer to print" parameter shows all of the active trend buffers that can be printed. This macro can be defined as a global macro and is thus defined on the All Pages index tab.

The second macro, Trend window, can be defined only on a local basis and must be defined from the Page n index tab. This macro allows for manipulation of the trend currently being viewed.

### **7.10.19 Trend Printing**

Trend buffers can be printed in either alphanumeric format or in graphic format. To print a trend buffer in alphanumeric format use the Trend buffer print macro (under Project - Keyboard Macro Editor - All Pages). To print in graphic mode, use Designer's report features (under Project - Report on Panel Printer - Reports). To do this, it is necessary to first create a page that contains the trend window.

### **7.10.20 Mailbox**

You can start a trend buffer printout by issuing a mailbox command.

The Mailbox command used to print a trend buffer is 0x00A1. The first mailbox parameter is the trend ID number. You can find the ID number assigned to the trend buffer by looking under Project - Trend Buffers.

The mailbox command response codes are:

0	OK Command executed successfully
1	ERROR Printer is busy (another print job in execution)
2	ERROR Invalid trend buffer ID

An example of using a mailbox command to start a trend buffer print is shown below:

DB10, DB01	<- 161 (0x00A1) Write the mailbox command code
DB10, DB02	<- 1 Write the trend ID
DB10, DB00	<- 1 Start the mailbox command

### 7.10.21 Trend Limitations

Some limitations of using trends are listed below. In addition, the available memory area in the PLC that can be used to store trend buffers is limited to 60 bytes.

Max number of trend windows inside the same page	10
Max number of curves inside the same trend window	10
Total number of curves that can be use inside the same page	20
Max number of global trend buffers sampled in background	20
Cyclical sampling period	1-9999 sec
The total memory reserved for trend buffer	20 KB

## 7.11 Working with Graphics

### 7.11.1 Working with Graphics

This section provides information on the new Designer graphics features.

These features can be divided into three major categories:

Simple Shapes

Graphics Libraries

Object Libraries

Additional information is provided on using Color Boxes.

## 7.11.2 Simple Shapes

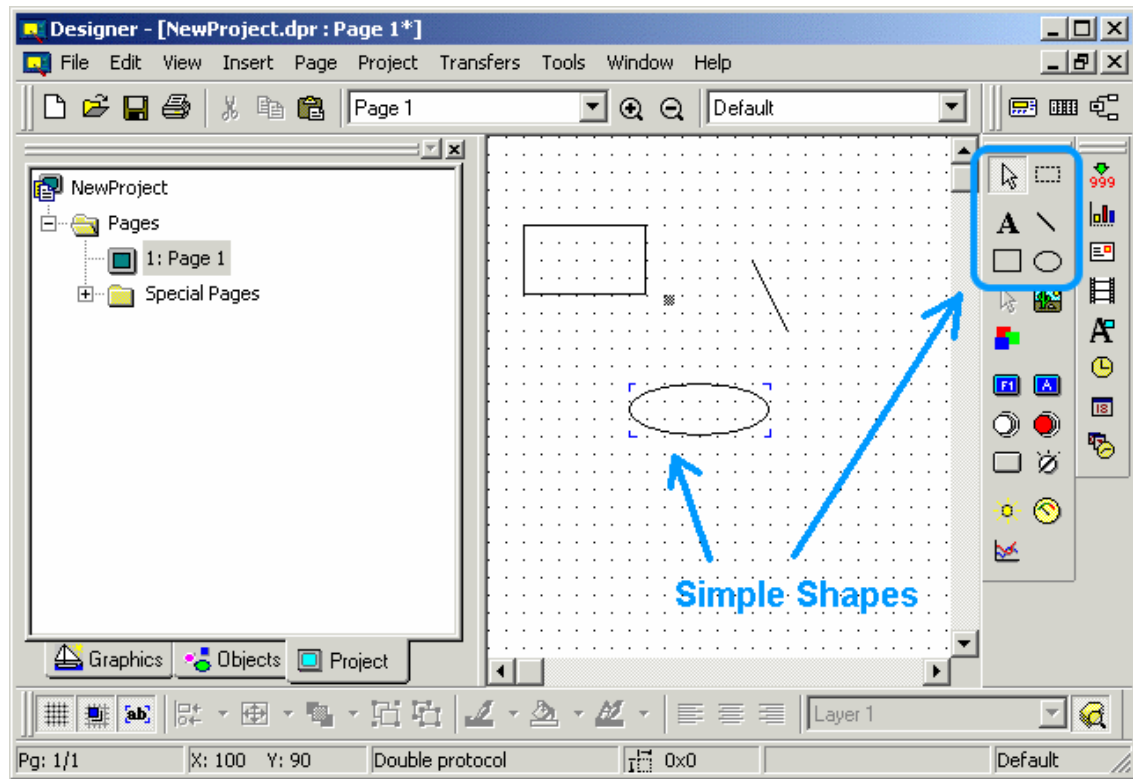

Designer enables its user to insert in their project simple vector graphics, simple shapes.

Once these simple shapes are created, it is possible to change their properties by right-clicking on them.

### Alignment

When two or more simple shapes are selected, it is possible to align them. To activate this function, select the Align command from the Edit menu.

### Size Adjustment

In the same way it is possible to alter the size of a group of shapes. To activate this function, select the Make Same Size command from the Edit menu.

### Grouping

Finally when two or more simple shapes are selected, it is possible to group them. To activate this function, right-click on the shapes and select the Group command.

### 7.11.3 Graphics Libraries

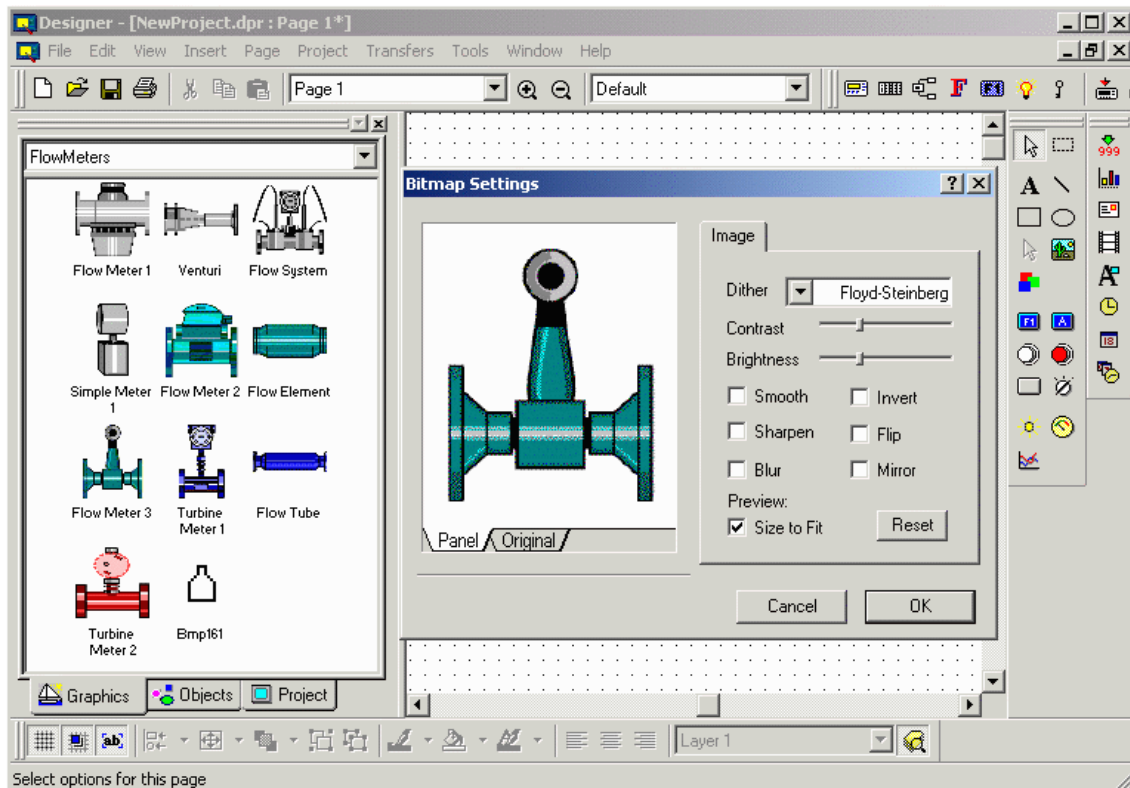

Designer is distributed with a rich set of predefined graphic symbols.

To use these symbols just select one of them from the right category (e.g. Arrows, Banners, Blowers, Callouts, FlowMeters, etc...) and drag-and-drop it on the Project Screen.

If necessary a BitMap Settings dialog box will pop up and allow you to adjust the symbol's graphic attributes to the panel currently selected inside the project.

By right-clicking on the "Graphics" area a set of commands are displayed. They are divided into the following categories:

#### EDIT COMMANDS

##### Copy

Allows to copy the graphic symbol into the clip-board so that it can be pasted into the Project Screen.

##### Remove

Removes the graphic symbol from the catalogue.

##### Rename

Changes the name of the graphic symbol.

#### CATALOGUE COMMANDS

##### New Catalogue

Creates a new catalogue

Open Catalogue

Opens an already existing catalogue

Close Catalogue

Closes the currently selected catalogue

#### IMAGE COMMANDS

Export

Exports the currently selected graphic symbol into a file (a picture) on the system.

Import

Imports a file (a picture) in the currently selected catalogue.

#### ICON COMMANDS

View

Allows to select how the graphic symbols are represented inside the catalogue (icons and names, icons only, names only)

Icon

Allows to change or to edit the icon of the currently selected graphic symbol.

## 7.11.4 Objects Libraries

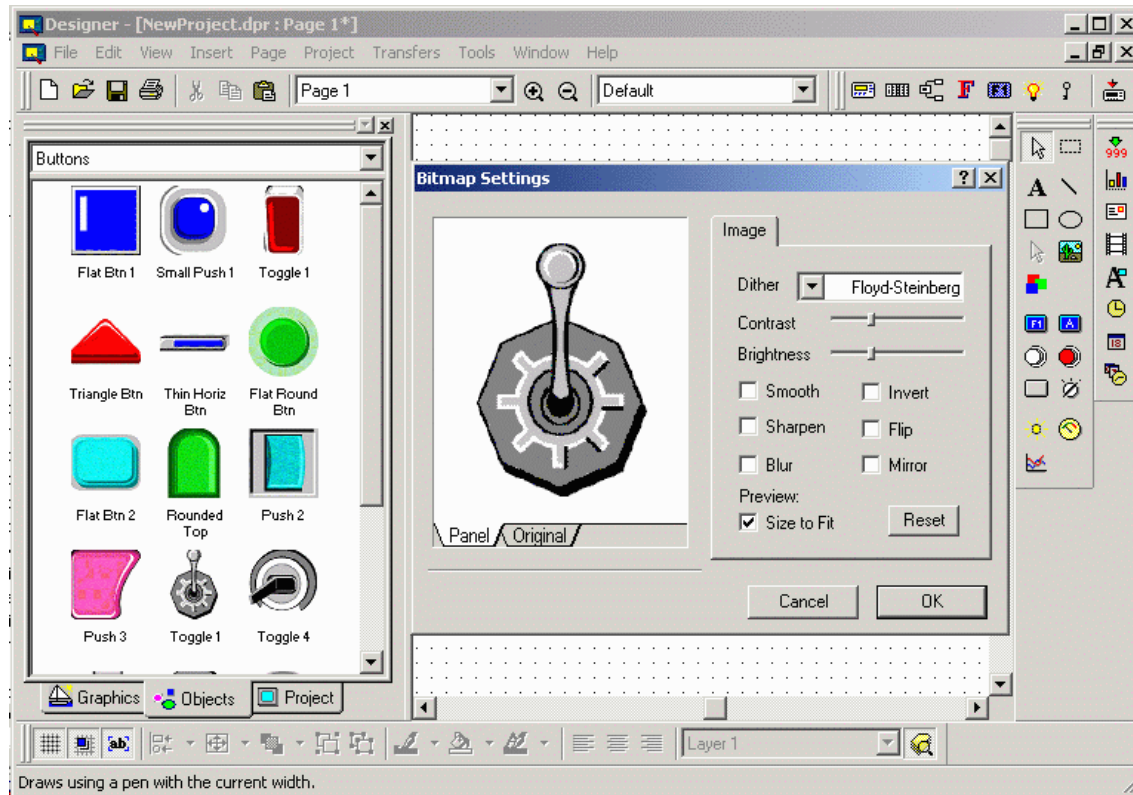

Designer is distributed with a rich set of predefined objects.

Objects are a something more than graphic symbols. Contrary to plain graphic symbols, objects may contain behaviour, objects may respond to user actions. Example of objects are Buttons, Lights, Switches, etc...

To use these objects just select one of them from the right category and drag-and-drop it on the Project Screen.

If necessary a BitMap Settings dialog box will pop up and allow you to adjust the symbol's graphic attributes to the panel currently selected inside the project.

Once the object has been put in the Project Screen area, if the object is active and possess a given behaviour, by right-clicking on the standard properties dialog box is displayed, as shown here below.

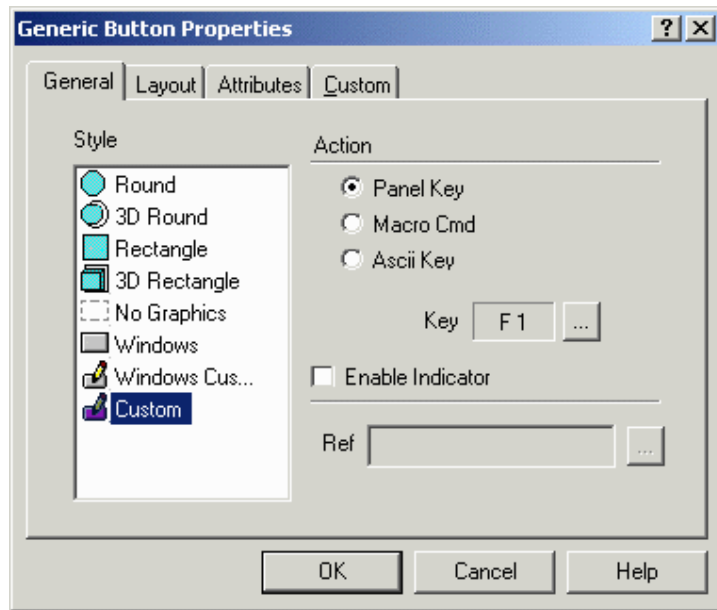

By right-clicking on the "Objects" area a set of commands are displayed. They are divided into the following categories:

#### EDIT COMMANDS

##### Copy

Allows to copy the currently selected object into the clip-board so that it can be pasted into the Project Screen.

##### Paste

Allows to paste into the currently selected catalogue an object previously copied into the clip-board.

Note: this feature is not available for graphics libraries.

Note: The union, via grouping, of one or more entities in the Project Screen is considered an Object.

##### Remove

Removes the object from the catalogue.

##### Rename

Changes the name of the object.

#### CATALOGUE COMMANDS

##### New Catalogue

Creates a new catalogue

##### Open Catalogue

Opens an already existing catalogue

Close Catalogue  
Closes the currently selected catalogue

## IMAGE COMMANDS

Export  
Exports the currently selected object into a file on the system.

Import  
Imports a file in the currently selected catalogue.

## ICON COMMANDS

View  
Allows to select how the objects are represented inside the catalogue (icons and names, icons only, names only)

Icon  
Allows to change or to edit the icon of the currently selected object.

### 7.11.5 Color Boxes

By selecting the icon shown here below



the user can insert a Color Box in the Project Screen area.

By right-clicking on the Color Box it is possible to change its properties.



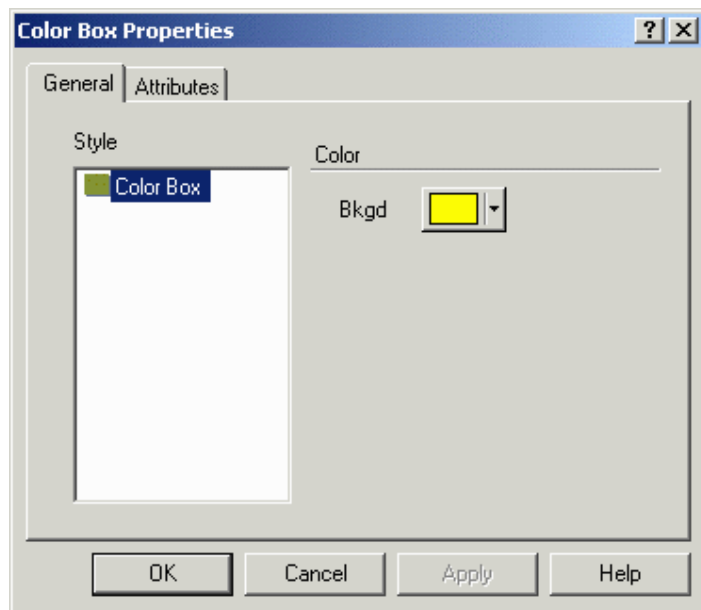

Color Box are useful to create backgrounds of a given color.

## 7.12 Ethernet Connectivity

### 7.12.1 Assigning IP Address to Panel

Every device in an Ethernet Network must have a unique IP address.

A UniOP operator panel with Ethernet connection capability must be assigned an IP address before it can communicate with a computer running the Designer software. UniOP is providing the users with the maximum flexibility in the assignment of the IP address. In fact there are several methods to do it and some well defined priority rules to sort which way will be the one active at a certain time.

The available methods to assign an IP address to a panel are:

- Manual definition of the address when the panel is in Configuration Mode
- Definition of IP address from Designer and UniDataExchange when the panel is in Configuration Mode
- Automatic assignment of IP address from DHCP server
- Definition of IP address in the project file

The IP address is a number in the usual form nnn.nnn.nnn.nnn where nnn is a number from 0 to 255.

Two parameters need to be defined by the user in addition to the IP address:

**Subnet Mask:** it is a number in the form nnn.nnn.nnn.nnn where nnn is a number with value either 0 or 255

**Gateway IP:** it is the address of the router that allows connection to other network segments. It is a number in the usual form nnn.nnn.nnn.nnn where nnn is a number from 0 to 255.

A detailed description of these address input methods is given below.

The UniOP show the IP address and the other Ethernet settings when it is in Configuration mode.

The following is the information shown in panel when in Configuration Mode.

```
UniOP 5.20
CONFIGURATION MODE
IP: 192.168.1.186
ETH: 0030D800043D
SN: 255.255.0.0
GW: 0.0.0.0
16:40:00 GMT+00:00
DST: off
```

### 7.12.2 Manual Definition of IP Address

When the panel is in the Configuration Mode, the user can manually enter the value of the IP address and other network parameters. The activation of the manual address entry procedure depends on the type of the HMI.

#### Touchscreen

If the HMI has a touchscreen, just touch the address you want to edit. The HMI will show the address entry page. When the introduction is complete, confirm with the Enter button. The procedure can be aborted pressing the Clear button.

#### Keypad

If the HMI has a keypad, you can enter the address entry mode pressing the two arrow keys Up and Down at the same time. Pressing the two arrow keys multiple time will cycle the data entry focus through all the available parameters. When the introduction is complete, confirm with the Enter key. The procedure can be aborted pressing the Clear key

The new IP address (or Subnet Mask or Gateway IP) becomes immediately effective when the data entry is confirmed with Enter.

The address assigned defined manually in Configuration Mode is persistent, once the IP address has been defined, it will be used by the panel until a new address is defined by the user. To remove a manually defined IP address, define the IP address 0.0.0.0.

Note: Before assigning an IP address to the panel, make sure it is a unique address in the network. Duplicate IP addresses will cause network errors.

### 7.12.3 Address Definition with Keypad

The procedure to define manually an IP address using the keypad is the following:

Digits must be entered one by one

Use Up/Down arrow keys to select the value of each digit

Use Left/Right arrow keys to move from one digit to next

Please remind that the maximum value for each element of the IP address is 255. There is no address consistency check in the manual IP address definition procedure.

#### **7.12.4 Definition of IP Address using Pick Panel in Designer**

You can modify the IP address of the panel also using Designer.

Open the Pick Panel dialog box (you can use either the icon in the toolbar or the item Pick Panel in the Transfer menu) and select the Change IP Address Properties icon.

Please refer Pick Panel: The Ethernet Control Panel for the detailed description of Pick Panel.

The address assigned defined using Pick Panel in Configuration Mode is persistent: once the IP address has been defined, it will be used by the panel until a new address is defined with an higher priority address definition method.

To remove an address defined with Pick Panel, enter the IP address 0.0.0.0 with Pick Panel or manually from the panel touchscreen/keypad.

#### **7.12.5 Assignment of IP Address from DHCP Server**

UniOP contains an implementation of the DHCP client protocol and can receive its IP address from a DHCP server, if this is present in the network.

The panel will use the IP address assigned by the DHCP server unless another address has been defined using a method having higher priority than DHCP assignment.

The address assigned by DHCP is persistent, that is, once the IP address has been assigned, it will be used by the panel even id the DHCP server is no longer present in the network. An IP address assigned by DHCP can be canceled either defining an address using a method that has higher priority.

#### **7.12.6 Definition of IP Address in the Project File**

You can define the IP address of the panel in the project file. To define the IP address open Panel Setup and select the External Devices tab.

The Ethernet Settings dialog box is shown in the figure below.

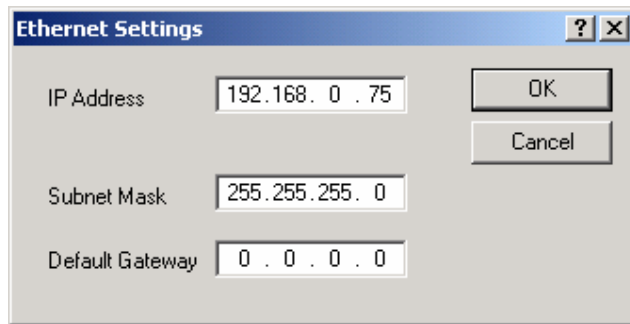

Note that the IP address defined in the project file will be active only when the panel is in Operation Mode.

When the panel will switch to Configuration Mode, it may change its IP address depending on previous settings.

**IP Address**

The current IP address of the panel. You can enter here an IP address in the form nnn.nnn.nnn.nnn where nnn is a number from 0 to 255.

**Subnet Mask**

It is a number in the form nnn.nnn.nnn.nnn where nnn is a number with value either 0 or 255.

**Default Gateway**

it is the address of the router that allows connection to other network segments. It is a number in the usual form nnn.nnn.nnn.nnn where nnn is a number from 0 to 255.

If you do not want to define an IP address in the project file, enter the IP Address 0.0.0.0 in the Ethernet Settings dialog box. If you do so, when the panel will be in Operation Mode, it will use either the address assigned by DHCP or the address defined manually by the user.

**7.12.7 Priority of IP Address Definition Methods**

There is a fixed priority scheme defining which IP address will be valid under all conditions. This priority scheme is necessary because there are multiple independent methods to define the IP address in the panel.

The UniOP panel will use the address that has been defined by the method with the highest priority, if present.

Priority	Configuration Mode	Operation Mode
Highest	Manual Definition with Pick Panel	Manual Definition with Pick Panel
		Definition in the Project File
Lowest	Assignment by DHCP	Assignment by DHCP

### 7.12.8 Example 1

A brand new panel with Ethernet interface is connected to a network that has a DHCP server. While the panel is in Configuration Mode it will receive the IP address by DHCP. The IP address assigned by DHCP will be shown on the display.

If the user wants to change this address, or the Subnet Mask, can activate the IP address edit mode and enter the new address manually.

Once the IP address has been defined manually, it will be persistent and will be maintained even when the power is cycled.

The only way to reset the manual definition and return to DHCP is to enter the IP address 0.0.0.0.

### 7.12.9 Example 2

A brand new panel with Ethernet interface is connected to a network that has no DHCP server. While the panel is in Configuration Mode it will show the on the display the IP address 0.0.0.0.

Start Designer and recall the Pick Panel dialog box.

The Pick Panel dialog box will show one panel in the list, the Physical Address will be present but there will be no IP Address.

Select Change IP Address Properties and enter a valid IP Address. The new address will be define in the panel when you will press the confirmation button.

Once the IP address has been defined by Designer, it will be persistent and will be maintained even when the power is cycled.

The only way to reset the manual definition and return to DHCP is to enter the IP address 0.0.0.0.

Note: Ethernet connectivity requires panel firmware V5.30 or greater and Designer 6.04 or above; Ethernet connectivity is NOT supported for units with firmware type 33 and 37

### 7.12.10 Selecting Ethernet Communication in Designer

To select Ethernet communication in Designer, select Transfer/Options and choose Ethernet Port as shown in the figure below.

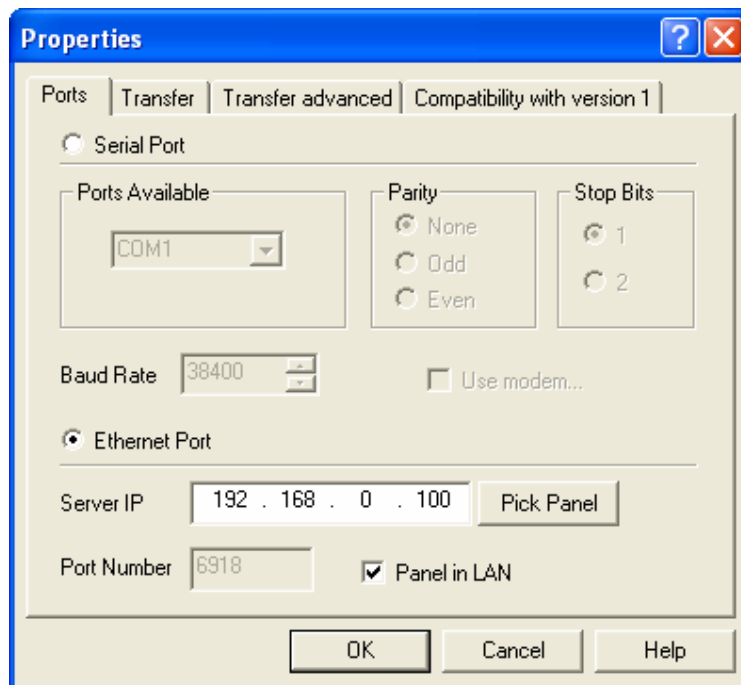

You can enter manually the IP address of the panel you want to connect to Designer. If you do not know the IP address of the panel, open the Pick Panel dialog box and select one of the panels in the list.

Note: If you want to communicate with a certain panel you must enter its IP address. Unlike the normal serial communication between Designer and panels, Ethernet connectivity allows you to have multiple panels networked with Designer and you need to select the one you want to program. The port number used by the Designer Ethernet protocol to communicate with the panels can be changed by un-checking the check box "Panel in LAN"; this can be useful in case the UniOP default port needs to be changed according to the LAN configuration and routing tables.

### 7.12.11 Pick Panel: The Ethernet Control Panel

Pick Panel is the tool provided by Designer to efficiently manage UniOP panels connected to an Ethernet network. Using Pick Panel you can:

- Select one panel in the network
- Change the IP address, the Subnet Mask and the Default Gateway of the panel you have selected
- Change the mode of the panel from Configuration to Operation or from Operation to Configuration

### 7.12.12 Selecting Panels in the Ethernet Network

Pick Panel will search the network for UniOP panels and will show them in a list. Note that Pick Panel will not show all network nodes but only UniOP panels.

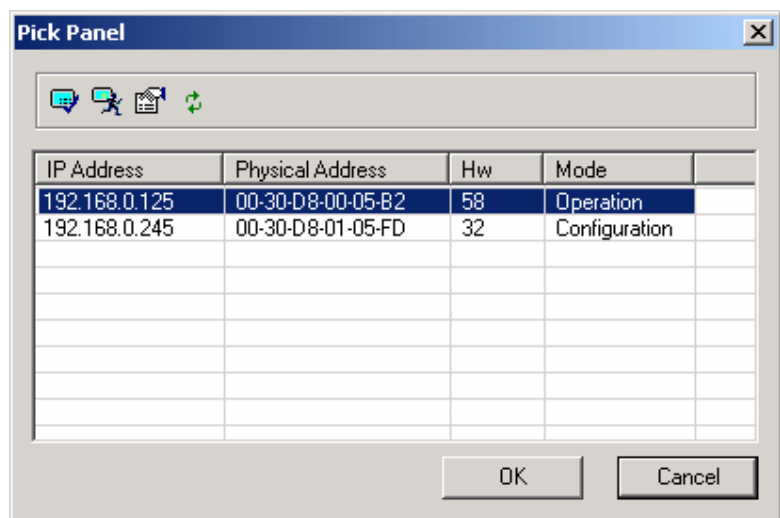

For each panel in the list, Pick Panel will show:

#### IP Address

It is the IP address assigned to the panel. If no IP address has been assigned to the panel, this field will show 0.0.0.0

#### Physical Address

It is the MAC identification number of the Ethernet interface in the panel. This is a fixed parameter and it is unique for each panel.

#### Hw

Hardware type of the panel. This is not enough to identify the panel model but it is a useful information.

#### Mode

Current operating mode of the panel. It can be either Configuration or Operation.

### 7.12.13 Changing the Operating Mode of Panels

Using Pick Panel you can change the operating mode of the panel you have selected. You can:

#### Switch to Configuration Mode

If the panel is in Operation Mode, it will be changed to Configuration Mode. This command is only available using Ethernet and is not available using serial communication with the panel. Changing the panel to Configuration Mode may take a few seconds.

#### Switch to Operation Mode

If the panel is in Configuration Mode and if it contains a valid project file, it will be changed to Operation Mode. Changing the panel to Operation Mode may take a few seconds.

Warning: Please note that the Switch to Configuration Mode command will work whatever is the current status of the panel. The panel will change to Configuration Mode even if it is showing alarms or even if it is in the middle of a data entry session. Special care is needed if

the panel connected via Ethernet is not visible from the operator using the Designer software and in all cases it is operating any kind of machinery.

### 7.12.14 Definition of IP Address

Pick Panel allows you to change online the IP address and its properties. From the Pick Panel dialog box, select the Change IP Address Properties icon. The dialog box shown in the figure below will appear.

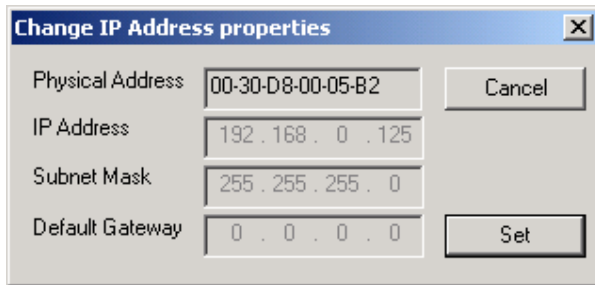

The dialog box includes the following elements:

#### Physical Address

MAC ID of the Ethernet hardware in the panel. This number cannot be changed by the user.

#### IP Address

The current IP address of the panel. You can enter here a new IP address in the form nnn.nnn.nnn.nnn where nnn is a number from 0 to 255.

#### Subnet Mask

it is a number in the form nnn.nnn.nnn.nnn where nnn is a number with value either 0 or 255.

#### Default Gateway

it is the address of the router that allows connection to other network segments. It is a number in the usual form nnn.nnn.nnn.nnn where nnn is a number from 0 to 255.

If you want to reset an IP address that has been defined manually in the pane, enter the IP Address 0.0.0.0 in the IP field in the dialog box. If you do so, the panel will use the IP address assigned by DHCP (if available) or the IP address eventually defined in the project file.

The address assigned defined using Pick Panel in Configuration Mode is persistent: once the IP address has been defined, it will be used by the panel until a new address is defined with an higher priority address definition method.

To remove an address defined with Pick Panel, enter the IP address 0.0.0.0 with Pick Panel or manually from the panel touchscreen/keypad.

### 7.12.15 Clock Synchronization with the SNTP Protocol

UniOP supports the standard SNTP protocol for clock synchronization.



If the network contains a time server, the panel will connect to the server and will synchronize its real time clock with the server.

This is a simple and powerful method to ensure that all the clocks of the panels in the network are synchronized.

### **7.12.16 Using UniDataExchanger**

UniDataExchanger is a simple but powerful tool that allows you to access data in the panels as well as downloading firmware updates.

UniDataExchanger supports both Ethernet and serial communication, please note, however, that some options are only available if the panel is connected via Ethernet.

### **7.12.17 Download Recipe Data**

This command is available both with serial and Ethernet connection. When the panel is connected via Ethernet, however, the command has been enhanced and recipe data can be transferred also when the panel is in Operation Mode.

### **7.12.18 Upload Recipe Data**

This command is available both with serial and Ethernet connection. When the panel is connected via Ethernet, however, the command has been enhanced and recipe data can be transferred also when the panel is in Operation Mode.

### **7.12.19 Upload Trend Data**

This command is available both with serial and Ethernet connection. When the panel is connected via Ethernet, however, the command has been enhanced and trend data can be transferred also when the panel is in Operation Mode.

### **7.12.20 Upload Event List**

The command Upload Event List allows UniDataExchanger to retrieve the Event List from the panel.

This command is available only with the Ethernet connection. The Event List data will be saved to a disk file in .csv format. The content of the file will be as shown in the figure below.

	A	B	C	D
1	Type	Alarm	Value	Time
2	on	0	0x20202020	5/31/2004 15:56
3	on	1	0x20202020	5/31/2004 15:56
4	on	2	0x20202020	5/31/2004 15:56
5	on	3	0x20202020	5/31/2004 15:56
6	on	4	0x20202020	5/31/2004 15:56
7	on	5	0x20202020	5/31/2004 15:56
8	on	6	0x20202020	5/31/2004 15:56
9	on	7	0x20202020	5/31/2004 15:56

### 7.12.21 Upload Alarm List

The command Upload Alarm List allows UniDataExchanger to retrieve the Alarm List from the panel.

This command is available only with the Ethernet connection.  
 The Alarm List data will be saved to a disk file in .csv format.  
 The content of the file will be as shown in the figure below.

	A	B	C	D	E	F	G	H	I
1	Static flags	Static flags	On time	Off time	Value	Link flags	Log flags	Fg/bg color	Fb/bg ack color
2	ALUSED   ALCLR	ALUSED   ALCLR	7/20/2004 11:03	1/1/1995 0:00	0	0	NONE	000f	00/00
3	ALUSED   ALTIMD	ALUSED   ALTIMD	7/20/2004 11:03	1/1/1995 0:00	0	0	NONE	000f	00/00
4	ALUSED   ALTIMD	ALUSED   ALTIMD	7/20/2004 11:03	1/1/1995 0:00	0	0	NONE	000f	00/00
5	ALUSED   ALCLR	ALUSED   ALCLR	7/20/2004 11:03	1/1/1995 0:00	0	0	NONE	000f	00/00
6	ALUSED   ALCLR	ALUSED   ALCLR	7/20/2004 11:03	1/1/1995 0:00	0	0	NONE	000f	00/00

The following is the meaning of the various fields.

**Static Flags**

Attribute of alarms as defined in the project file.

ALUSED  
Alarm Enabled

ALCLR  
Alarm requires acknowledgement

ALPRON  
Print Alarm on Event

ALPROF  
Print Alarm off Event

ALPRAC  
Print Alarms Acknowledgement.

ALWARN  
"Message Only Alarm" (does not turn on Alarm LED)

ALLOGEV  
Events for this alarm

Dynamic Flags

Current Status of the alarm at the moment of the upload.

ALON

Alarm is ON

ALACK

Alarm requires Acknowledgement.

ALSILENT

Silent Alarm (set for "events only" alarms)

On time

Time when the alarm went on.

Off time

Time when the alarm went off.

Value

Not used

Link Flags

Specifies if the alarm is linked to an help screen.

0

Alarm non linked to alarm page

1

Alarm linked to alarm page

Log Flags

Not used

Fg/Bg Colors

Foreground/Background colors defined for the alarm, 00/00 means no colors used.

Fg/Bg ACK colors

Foreground/Background colors defined for the alarm when acknowledge is required, 00/00 means no colors used.

## **7.12.22 Selecting Ethernet Communication in UniDataExchanger**

To select Ethernet communication in UniDataExchanger, select Options > Communication and choose Ethernet Port as shown in the figure below.

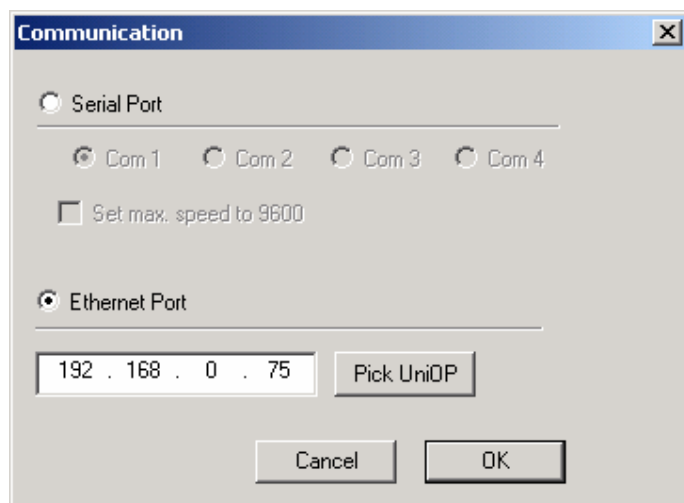

You can enter manually the IP address of the panel you want to connect to UniDataExchange. If you do not know the IP address of the panel, open the Pick Panel dialog box and select one of the panels in the list.

Note: If you want to communicate with a certain panel you must enter its IP address. Unlike the normal serial communication between UniDataExchange and panels, Ethernet connectivity allows you to have multiple panels networked with UniDataExchange and you need to select the one you want to connect.

### 7.12.23 Basic Ethernet Diagnostic with Ping

UniOP supports the Ping protocol as a very simple network diagnostic method.

Just enter the Ping command, followed by the IP address of the panel, from any node in the network. If the panel can be reached, it will respond to Ping.

## 7.13 Getting Started with B Series Panels

### 7.13.1 The New Hardware Platform for UniOP Panels

The new “B” series of panels is a completely new hardware platform called “T2003”. The T2003 CPU board uses a new 200 MHz 4131 MIPS processor.

The B series uses a new Firmware Type called FW60.

### 7.13.2 New Features Available in the T2003 Platform

The new hardware platform brings up to the product a set of interesting new features:

- Support for 64K color systems on panels with TFT display
- Support for 256 colors on panels with STN display
- Support for 8 levels of gray on panels with monochrome display
- 32MB Internal Memory Card and optional SSFDC External card

Video Input Option for panels with TFT displays  
Backlight dimming for panels with TFT display

### 7.13.3 Support for 64K Colors

The support for 64K colors is available only on B units with TFT display.  
To enable the 64K colors support select the “High Colors” option into the “Settings” tab from “Panel Setup”.

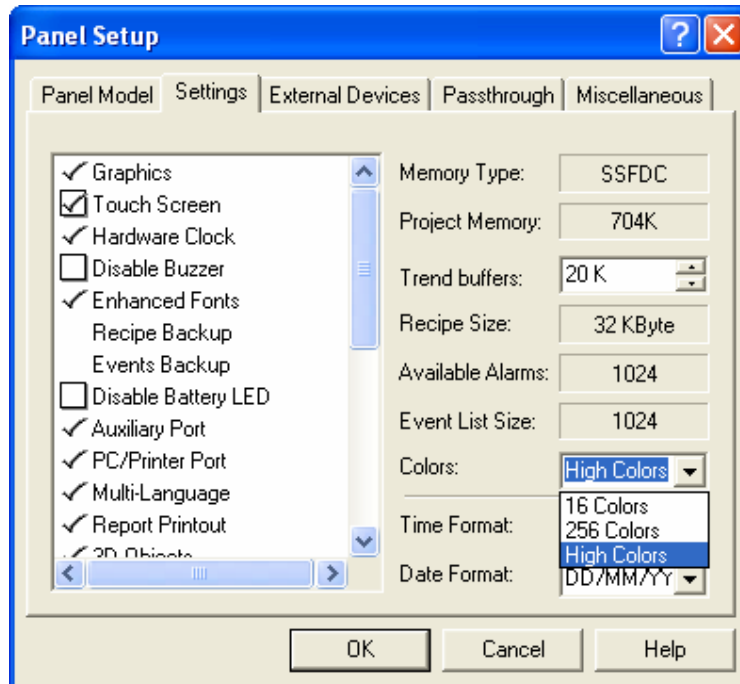

Selecting 64K color support in Panel Setup

The High Colors option can be used only in the following screen objects:

- Dynamic graphics
- Bitmap editor
- Imported images
- Video input windows

All the other screen objects, such as text and touch objects, support 256 colors.

### 7.13.4 The FW60 Memory Architecture

The memory organization of the T2003 hardware platform is shown in the block diagram of below figure.

The picture shows the relation between the internal user memory, the external SSFDC memory card contents and the system-level memory storage in the panel.

The reference to this picture may be useful to understand the subsequent chapters of this document, with particular reference to the chapter on Internal Memory.

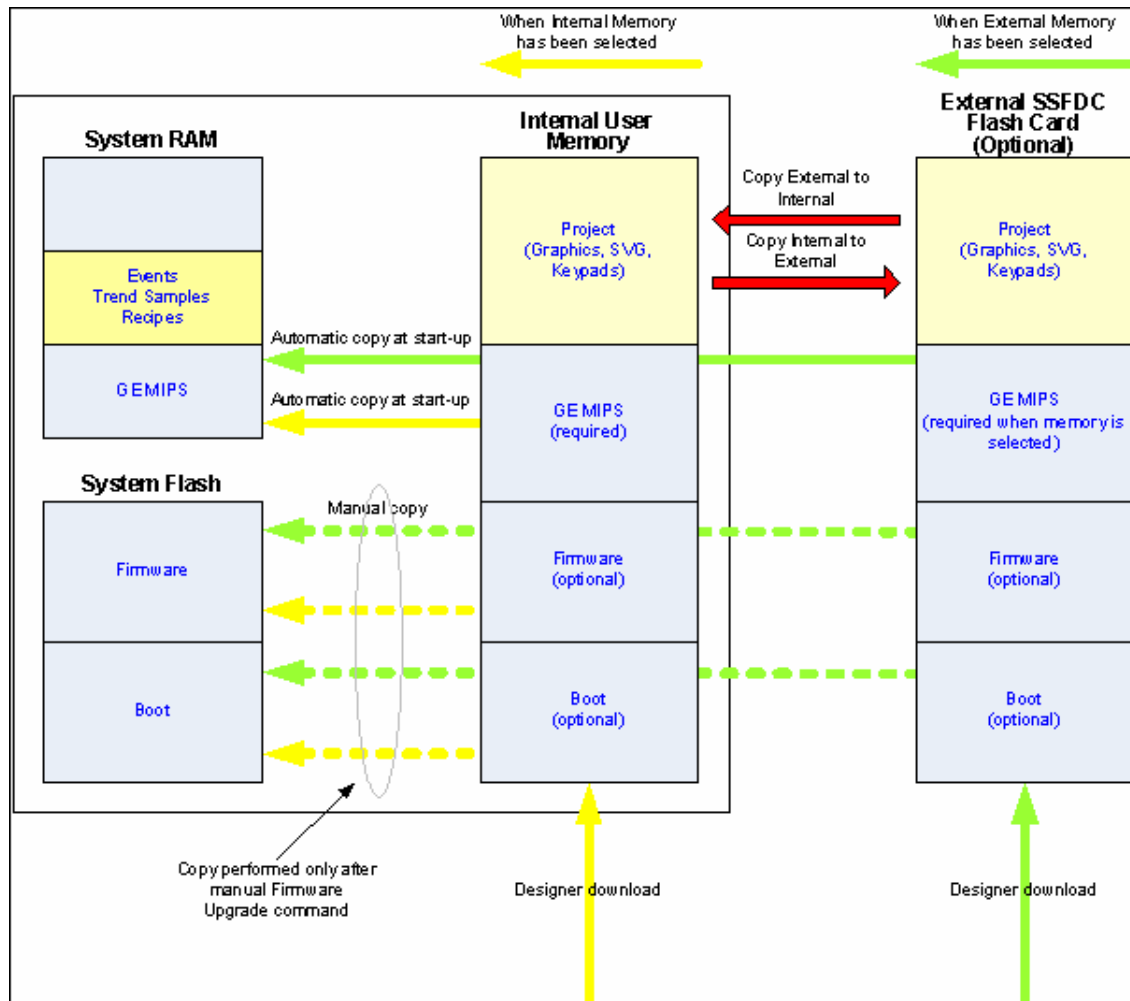

T2003 Memory Organization

### 7.13.5 The Internal Memory

The B series units have 32 MB internal Flash memory dedicated to project file components and firmware files in the same way as the SSFDC card is used on the T2000 platform.

This memory will be the standard storage location for both user application and firmware files.

The SSFDC socket is still present in the T2003 CPU and can hold an additional SSFDC memory card.

Note: B-series units are delivered without the SSFDC card in the external socket.

The Firmware Type 60 includes some new controls to handle the two memory locations.

At any time only one memory can be considered “active”. The run-time software will run the project and the firmware components only from the active memory.

The memory selection can be done using a special memory setup menu activated in Configuration Mode by pressing and holding down for 2 seconds the right arrow key.

The menu is shown in below figure:

```
Memory setup
Select Format Copy Exit

-> Panel Memory - 32MB, 2% used
Flash Card - 32MB, 6% used
```

When the menu is activated a cursor will blink over one of the four available options: Select, Format, Copy and Exit.

Select  
selection the active memory

Format  
formatting the active memory

Copy  
copy from the active memory to the other one

Exit  
exit from the Memory Setup menu to Configuration Mode

To Select a memory type, place the blinking cursor over the “Select” option and confirm with OK; the blinking cursor will move the memory indicator represented with the arrow symbol; the cursor can be moved using the up/down keys; once selected the desired memory type, confirm with OK.

When doing a Copy process all the contents of the source memory will be copied to the destination memory. The currently active memory location is always considered as the source.

### 7.13.6 Firmware 60 Files

Firmware Type 60 has only three components; please note this is different from the older FW58:

Boot  
Firmware  
MIPS

The MIPS file is the only one that must always be present in the active user memory either this is the internal memory either it is the flash card.

The Firmware Upgrade menu will only show the Boot and the Firmware components; they are the only two components the system will need to copy from the active user memory to the internal System Flash.

### 7.13.7 Video Input Option

The Video Input option is available using the VMO10 module that is delivered as a separate product and requires installation by the user. Please refer to the product datasheet Tn209 and to the installation guide for specific information about specification and installation.

### 7.13.8 How to Create a Video Input Object

To create a video input object just select “Insert\Video Input” or use the icon available in the toolbar:

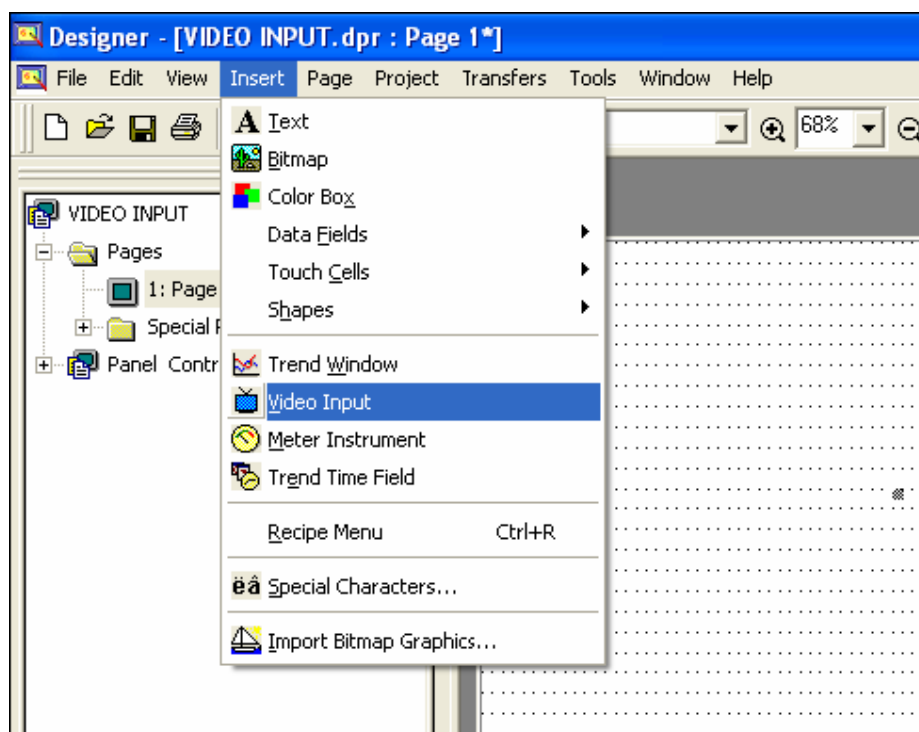

Figure 4 – Creating Video Input Objects

The menu item and the icon are active only if the project has been configured for a panel model that supports the Video Input Option. Please remind that icons layout can be restored to the default settings using the “Default” button in the “Tools\Customize” dialog box.



### 7.13.9 Video Input Type

The video module is provided of 1 VGA input and 3 PAL inputs; the source of the video input object placed in the Designer project page can be selected using the related list box in the “Video Input Properties” dialog box shown in the below figure.

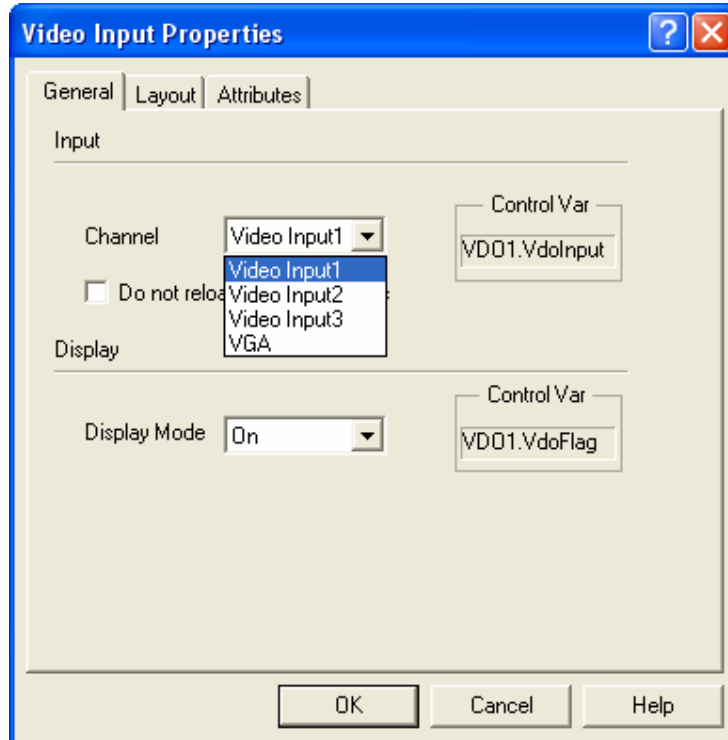

Property Sheet for Video Input Objects

Note: The Video Input Type can be selected also from the panel screen using the appropriate Control variable.

### 7.13.10 Display Mode

Display Mode defines how video input objects are initialized. Two options are available for the Display Mode:

On  
Off

Display Mode can be set in the “Video Input Properties” dialog box as shown in the below figure.

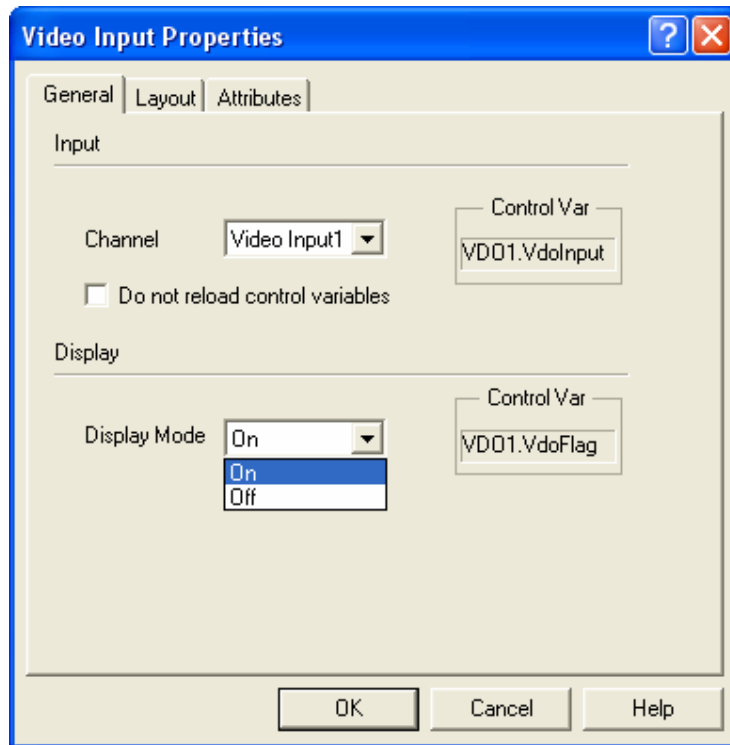

**On**  
makes the input image immediately visible in the Video Object after project download

**Off**  
the image from the video channel is not shown in the “Video Object” and needs later to be in case enabled using the dedicated Control Variable

Note: The Display Mode can be selected also from the panel by using the apposite Control variable.

### 7.13.11 Color and Video Options

The “Layout” tab of the Video Input Properties dialog box contains several options for video objects as shown in the below figure.

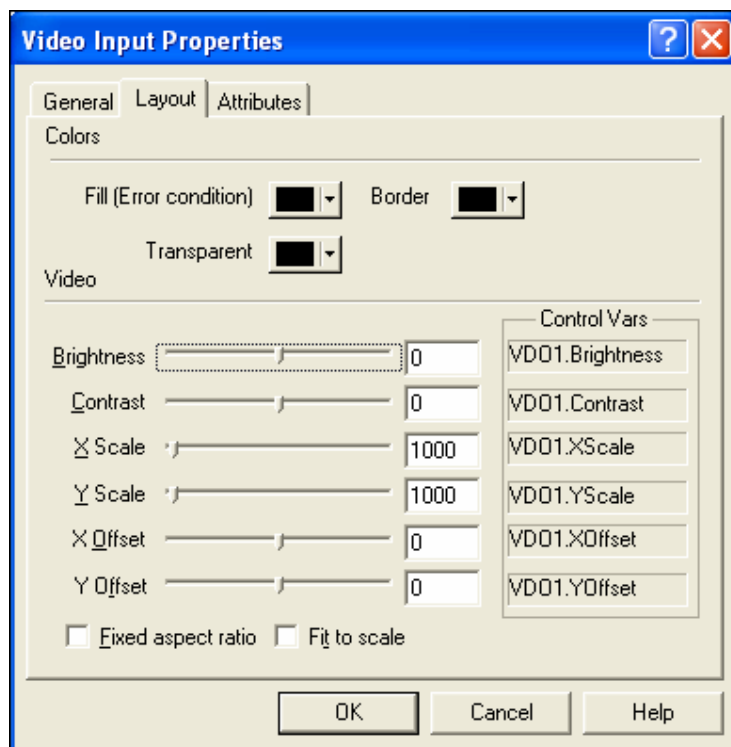

Note: Video Options can be changed at run time using the proper Control variables

#### Fill error conditions

It is the color used to fill the video object in case, for instance, no signal is detected at the video input

#### Border

The color of the border of the Video Input window.

#### Transparent

The parts of the image filled with the selected transparent color will be transparent.

#### Brightness

Brightness level. The range is from -128 to 127, with zero as a normal level.

#### Contrast

Contrast level. The range is from -128 to 127, with zero as a normal level.

#### Scale

The picture can be scaled along both dimensions. The value is measured in per-mills of the original video stream, meaning that a value of 1000 returns the image in the original size; values greater than 1000 will zoom in, while values smaller than 1000 will zoom out. Scaling limits are resolution dependent; the scale values will be anyhow forced to allowed limits. Additionally, the hardware interface will round off the specified scaling factors to match its internal calculation capabilities; this will result in a picture on panel slightly smaller than programmed one.

#### Offset

The top-left position of a window within the video stream that will be displayed. Into the

Video Object the input stream will be displayed starting from the specified position and cropped on right/bottom borders.

#### Fixed aspect ratio

Scaling will be performed in a way that original stream's aspect ratio is preserved; vertical scaling factor will be ignored.

#### Fit to scale

If set, all offset and scaling parameters will be ignored; a stream will be scaled in a way that it is completely visible.

### 7.13.12 Control Variables

Video Input parameters can be adjusted also at run time using the dedicated Control Variables; to select a Control Variable select "Variable" in the "Numeric Field Properties" dialog box as shown in the below figure.

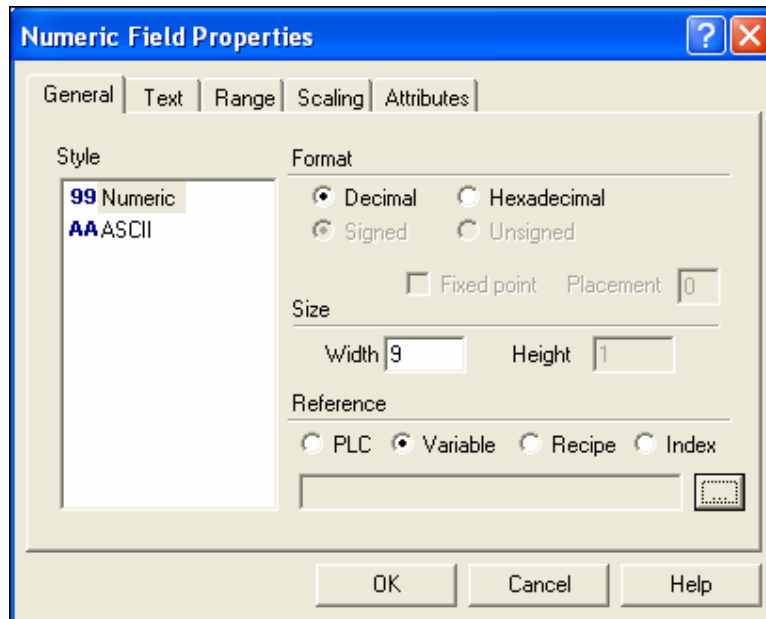

Then select "Internal variable" for the Data Type as shown in the below figure.

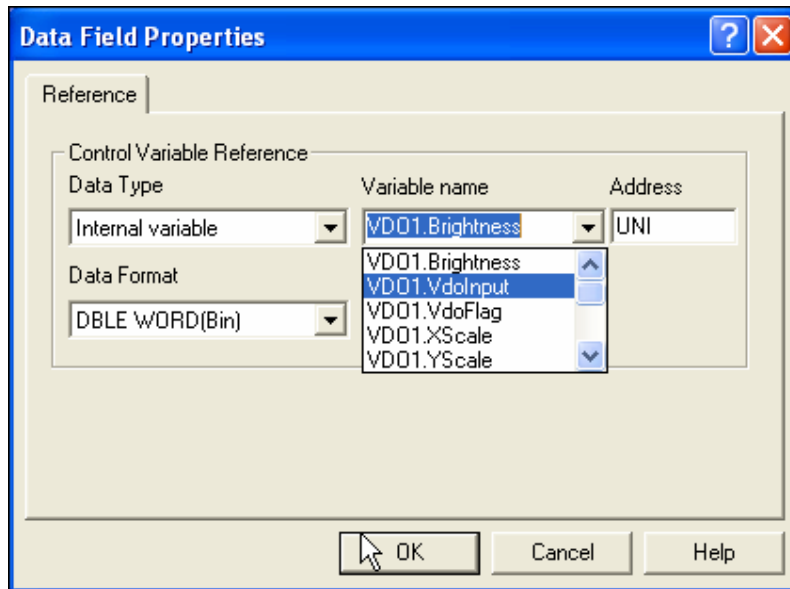

The following Control Variables are available for use with Video Input objects:

VDOx.XOffsetV

DOx.YOffset

Specify the top-left position of a window within the video stream that will be displayed. Only positive values are allowed.

VDOx.XScale

VDOx.YScale

The picture can be scaled along both dimensions. The value is measured in per-mills of the original video stream, meaning that a value of 1000 returns the image in the original size; values greater than 1000 will zoom in, while values smaller than 1000 will zoom out. Scaling limits are resolution dependent; the scale values will be anyhow forced to allowed limits. Additionally, the hardware interface will round off the specified scaling factors to match its internal calculation capabilities; this will result in a picture on panel slightly smaller than the one that has been programmed.

VDOx.VdoInput

Selection of the Video Input channel to be displayed in the Video Input object; valid values are the following:

0 – Video Input 1 (CVBS)

1 – Video Input 2 (CVBS)

2 – Video Input 3 (CVBS)

3 – RGB Input

VDOx.VdoFlag

This variable contains some status flags to identify the status of the Video Input object:

bit 0 (0x01) – do not reload internal variables (if not set, video object' state will be saved across page changes)

bit 1 (0x02) – fixed aspect ratio (scaling will be performed in a way that original stream's aspect ratio is preserved; vertical scaling factor will be ignored)

bit 2 (0x04) – turn off (if set, video object will not display a video stream)

bit 3 (0x08) – reserved (do not use)  
bit 4 (0x10) – reserved (do not use)  
bit 5 (0x20) – fit to scale (if set, all offset and scaling parameters will be ignored; a stream will be scaled in a such way that it will be completely visible in the window)

**VDOx.Brightness**

Brightness level. The range is from –128 to 127, with zero as a normal level.

**VDOx.Contrast**

Contrast level. The range is from –128 to 127, with zero as a normal level.

**VDOx.VdoStatus**

Read only register containing some information related to the Video Input object status:

bit 0 (0x01) – VGA signal displayed  
bit 1 (0x02) – PAL signal displayed  
bit 2 (0x04) – signal is valid

**VDOx.Hres**

Read-only register containing the horizontal resolution of an object's video stream.

**VDOx.Vres**

Read-only register containing the vertical resolution of an object's video stream.

**VDOx.VFreq**

Read-only register containing a vertical frequency of an object's video stream.

### **7.13.13 Backlight Dimming**

The T2003 platform for units with TFT display adds the possibility to use the dimming function for the display backlight.

The brightness of the backlight can be controlled using the macro commands shown in the below figure.

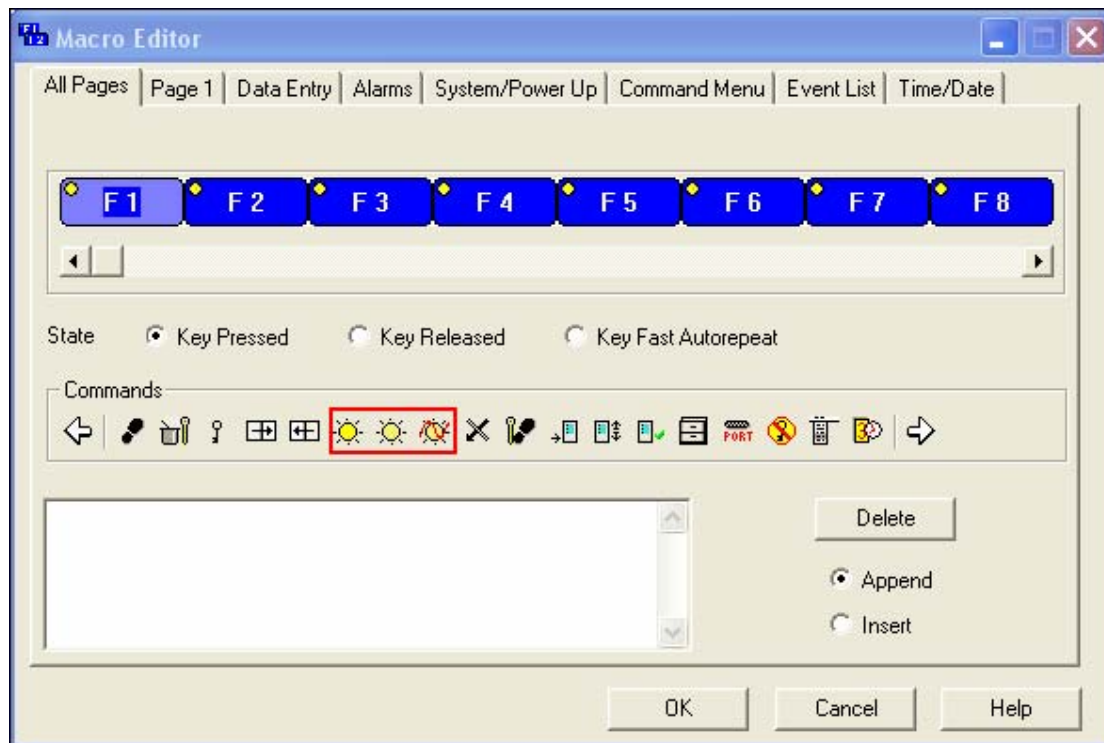

The brightness can be decreased, increased and changed in cycle with steps using the macro “Dimming”. The display brightness can be reduced up to 2% of the maximum value.

#### 7.13.14 Compatibility Issues

The “B generation” units are delivered without removable memory card; user memory is the internal 32MB Flash memory as a factory setting.

From the point of view of transferring a new project file to the panel, there are no differences in handling the download whether you use internal memory or Flash card. The memory selection is done in Configuration Mode and no settings are required at Designer level.

The “Copy” option of the Memory Setup menu can be used to transfer the entire contents of an external SSFDC card to the internal flash. The external card must be of course prepared with proper firmware files, Type 60, and correct project matching the hardware type, according to the Designer Panel Setup selection.

SSFDC cards already programmed for units with firmware type 58 are not compatible with “B” series panels.

In the same way, memory cards prepared for units with firmware type 60 are not compatible with units using T2000 hardware platform.

The project stored on a memory card suitable for use with firmware 58 units cannot be copied to the internal memory of a “B” series unit. The copy option operates only for the entire memory contents.

Any “B” series unit to be used as a replacement of existing Firmware 58 panels must be completely prepared at early stage and must be sent to site ready for installation.

## 8 Index

6	
64K Colors	
Support .....	487
64K Colors .....	487
A	
About TagEdit.....	296
Absolute Coordinates.....	315
Access .....	69
Access Information	
Using UniDataExchange .....	483
Access Information .....	483
Access Protected Function	
S5 Attempt.....	428
Access Protected Function .....	428
ACK .....	242
Action.....	113
Add.....	234, 236
Add All .....	232
Add Page.....	182
Advanced .....	336
Advanced Network Programming .....	407
Advanced Report Parameters.....	421
Advanced tab .....	237
Alarm Page .....	189
Align .....	234, 236
Align Bottom .....	26
Align Horiz Center.....	26
Align Left.....	25
Align Right .....	26
Align Top.....	26
Align Vert Center.....	26
Alignment .....	322
All Pages .....	254
All Panels	
LED Map.....	430
All Panels.....	430
ALOGI.....	242
ALOGO .....	242
Appearance .....	149
Arc Colors.....	165
Arguments.....	234, 236, 331
ASCII Data Field Example .....	72
ASCII Key Button.....	112
ASCII Key Button Touch Cell Example.....	116
Assign	
IP Address .....	475
Assign .....	137
Assign .....	475
Associated Fields .....	315
Assumptions .....	9
Attribute Data Fields.....	85
Attribute Example.....	94
Attribute Transformations .....	238
Attributes .....	110, 115, 121, 127, 144
Auto Linefeed .....	228
Automatic Clear.....	256
Automatic Firmware Upgrade Procedure .....	363
Available Alarms .....	200
Avoid Field .....	315
B	
Background.....	155
Background Color.....	156
Background tab .....	316
Backlight Dimming .....	496
Bargraph Data Fields .....	73
Bargraph Example .....	77
Bargraph Preview .....	74
Bargraphs.....	303
Basic Ethernet Diagnostic.....	486
Basics.....	348
Baud Rate .....	194
Bitmap Editor.....	42
Blur .....	181
Border .....	316
Brightness .....	181
Broadcast Periodic Clock .....	213
Buffer Types .....	463
Buffers .....	252
Bug	
Report.....	13
Bug.....	13
Buttons	
Creating .....	319
Buttons.....	319
Buttons.....	327
Buzzer .....	198, 433
C	
C0 Print Screen.....	432



C1 Disable Data Entry .....	432	Configured Nodes .....	214
C15 Enable Mailbox .....	432	Configuring	
C2 Select Alarm Mode.....	432	Ethernet .....	400
Cascade .....	341	Project .....	460
Categories .....	327	Recipe Parameter Sets.....	434
Center .....	167	Trend Buffer .....	462
Center Color.....	167	UniNET Networks .....	372
Cfg Mode .....	205	Configuring.....	372
Changing		Configuring.....	400
PLC Drivers.....	459	Configuring.....	434
Changing .....	459	Configuring.....	460
Characters		Configuring.....	462
Editing .....	304	Confirmation.....	383
Characters .....	304	Connect	
Check Firmware Versions.....	364	Panel.....	12, 400, 405
Clear Buffer .....	256	Tags .....	338
Clear Event List .....	384	Connect.....	12
Clients .....	390	Connect.....	338
Clock Synchronization.....	482	Connect.....	400
Close .....	309	Connect.....	400
Code .....	320	Connect.....	405
Color Boxes .....	474	Connection Messages .....	273
Colors.....	150, 322	Connectivity	
Column.....	234, 236	Extending .....	408
Column Menu .....	301	Connectivity.....	408
Comm Port		Contact Information.....	13
Network.....	216	Contents .....	170, 329
Comm Port.....	216	Contrast.....	181
Comm Time Out .....	216	Control Variable Change .....	257
Command Menu.....	188	Control Variable Event.....	256
Command Menu Access .....	207	Control Variables.....	435
Command Response Word .....	376	Controller.....	192, 218
Commands .....	205, 330	Controller Control Word.....	431
Communication Parameters .....	313	Controller Driver .....	214
Communications Number		Controller List.....	249
Retries.....	269	Controller Mode.....	191
Communications Number .....	269	Controller Model .....	214
Communications Parameters Setup .....	194	Controller Selection .....	356
Compatibility .....	271	Controller Update Area.....	429
Compatibility Information .....	398	Controllers Setup .....	356, 370
Compatibility Issues.....	497	Conventions .....	9
Complex Recipe Example.....	452	Converter PLC Port .....	402
Components .....	313	Converter Printer Port.....	402
Compress Graphics .....	269	Cool Look .....	325
Compressing		Copy.....	82
Panel Fonts .....	419	Count .....	160
Compressing .....	419	Creating	
CONF.....	241	Buttons .....	319
Configuration mode		New File .....	359
Switch.....	276	New Report .....	421
Configuration mode .....	276	Pressure Indexed Field .....	65
Configuration mode .....	277	Project .....	359
Configure Tag Dictionaries.....	248	Project File .....	414, 415

Recipe Menu Field .....	443	Delete Records.....	293
Stage Numeric Data Field .....	64	Description.....	327
Temperature Indexed Field.....	64	Designer.....	458, 479
Time Indexed Field .....	66	Designer Print Setup.....	18
Value Objects .....	321	Designer Screen.....	348
Creating.....	64	Designer Setup.....	355
Creating.....	64	Dial .....	277
Creating.....	65	Dial Timeout.....	274
Creating.....	66	Dictionary Menu.....	291
Creating.....	319	Direct Access.....	189
Creating.....	321	Direct Page Selection.....	189
Creating.....	359	Direction .....	164
Creating.....	359	Disable Battery LED.....	198
Creating.....	414	Disable Screen Saver .....	387
Creating.....	414	Disable Undeclared Client Access.....	212
Creating.....	415	Disclaimer.....	14
Creating.....	421	Disk.....	38
Creating.....	443	Display Page on Communication Error .....	206
Current Page.....	254	Displaying	
Current Page Mode .....	189	SSFDC Error Codes .....	264
Current Page Register .....	221	Displaying.....	174
Cursor.....	150	Displaying.....	264
Cursor Color.....	153	Dither .....	181
Curves .....	149	Double Protocol .....	367
Custom .....	145	Download	
Customize .....	295	Panel.....	311
Cut.....	24, 291	Panel Fonts .....	418
Cyclic .....	256	SSFDC .....	263
D		Uploading.....	372
Data Bits .....	229	Download.....	263
Data Entry		Download.....	271
Time Out.....	207	Download.....	311
Data Entry .....	207	Download.....	361
Data Entry Enable .....	242	Download.....	372
Data Entry Field Number.....	54, 439	Download.....	418
Data Entry Screen .....	188	Download Compress Options .....	271
Data Entry Status .....	53, 439	Dynamic Attributes.....	86
Data Field Properties.....	49	Dynamic Graphics Data Fields .....	94
Data Fields .....	44	Dynamic Graphics Example .....	99, 100
Data Transfer .....	346	E	
Database.....	249	Edit Dynamic Graphics.....	98
Date.....	189	Edit Menu .....	299
Date Data Field .....	102	Editing	
Date Data Field Example .....	103	Characters.....	304
Date Format .....	200	Editing .....	304
Date Settings .....	358	Eight User LEDs	
Decimal Hexadecimal Base .....	48	LED Map.....	430
Default .....	326	Eight User LEDs.....	430
Default Font .....	238	Eject .....	228
Define Symbol .....	303	Enable Auto Scroll Control .....	152
Delete .....	239	Enable Double Protocol.....	191, 216
Delete Dictionary .....	289, 292	Enable Indicator.....	143
Delete Page .....	182	Enable RDA.....	219

Enable Screen Saver .....	387	File_Exporttotagdb .....	21
Enable Tags.....	249	Fill Menu .....	300
Enable UniNET Network.....	213	Find.....	291
Enabling		Firmware Download .....	199
Interlock Mailbox .....	374	Firmware Files Directory.....	366
Multiple-Protocol Configuration .....	368	Firmware Version .....	197
Enabling .....	223	First Client .....	414
Enabling .....	368	First Record .....	293
Enabling .....	374	Fit	
Erase NiceFonts .....	337	Size.....	181
Erase Protocols.....	337	Fit.....	181
Error Codes .....	264	Fixed Point Placement .....	48
Escape Sequences .....	228	Flash.....	447
Ethernet		Flip.....	181
Configuring .....	400	Font	
Ethernet.....	209, 397	Saving.....	305
Ethernet.....	400	Selecting.....	360
Ethernet Board .....	202	Font.....	27, 155
Ethernet Communication		Font.....	305
Selecting .....	479	Font.....	360
Ethernet Communication .....	479	Font Editor .....	297
Ethernet Control Panel.....	480	Font Editor Example.....	304
Ethernet Network.....	405	Font Header .....	300
Event List Size .....	200	Font Menu.....	299
Event Page .....	189	Font Size .....	300
Events Backup .....	198, 428, 447	Footer.....	235
Events Run-time Backup .....	448	Foreground.....	155
Example		Format.....	47
Scaling .....	71	Format SSFDC.....	336
Example .....	71	Frame .....	155
Example .....	71	Frames tab.....	97
Exit.....	310	Full.....	257
Export		Full Screen .....	34
ROM File.....	311	FW Rescue Mode .....	337, 366
Export.....	214	FW60 Memory Architecture.....	487
Export.....	311	G	
Export Strings .....	21	Gauge .....	164
Export Tags Step.....	286, 287, 288	Gauge X.....	162
Exporting Tags.....	286, 457	Gauge Y .....	162
Extending		General.....	132
Connectivity .....	408	General Characteristics .....	390
Extending .....	408	General tab.....	231
External Devices tab .....	201	Generic Command Button .....	140
External Memory Types .....	269	Generic Command Button Touch Cell	
F		Example .....	145
Field Selection		Get Current Language.....	385
Time Out.....	207	Get Panel Resources .....	274, 372
Field Selection .....	207	Get Parameter Set Number .....	380
Field Type .....	234, 236	Get Recipe Transfer Priority.....	380
Fields		Getting	
Placing .....	370	Help .....	355
Fields.....	233, 235	Getting .....	355
Fields.....	370	Graphical Symbols.....	394

Graphics .....	344, 468	Interlock Mailbox	
Graphics Library .....	35, 470	Enabling .....	374
Grid		Interlock Mailbox .....	374
Snap .....	335	Interlock Mailbox .....	445
Grid .....	335	Interlock Mailbox Commands .....	377
Grid .....	335	Interlock Reference.....	223, 375
Grid Size .....	317	Internal Flash Memory .....	364
H		Internal Memory .....	488
Hang Up .....	278	Internal Panel Control Variables.....	467
Hangup .....	273	Internal Variable .....	254
Hardware.....	204	Invert.....	181
Header .....	233	IP Address	
Height.....	233, 235	Assigning.....	475
Help		IP Address.....	216
Getting .....	355	IP Address.....	475
Help.....	355	K	
Help Menu .....	296	Keep RDA Continuous .....	219
Horizontal Align .....	321	Keyboard .....	314
Horizontal Position .....	316	Keyboard Macro Editor .....	441
I		Keyboard Update Area .....	425
Illuminated Push Button .....	123	Keypad Designer .....	306
Illuminated Push Button Example .....	129	Keys .....	220
Image .....	99	L	
Import.....	214	Label .....	162, 320
Import Bitmap Graphics .....	175	Label section.....	320
Import Bitmap Graphics Example .....	177	Labels Color.....	162
Import Strings .....	23	Labels Font .....	163
Import Tags.....	282	Languages	
Import Tags Step.....	282, 283, 284, 285	Number.....	248
Index .....	62	Languages .....	54, 231, 247
Indexed Addressing Example .....	63	Languages .....	248
Indicator Light .....	135	Large Buttons.....	325
Indicator Light Touch Cell Example .....	139	Large Characters .....	302
Indirect Addressing Fields .....	62	Last Record.....	293
Initial Directory.....	332	Layers .....	38
Input .....	225	Layout.....	467
Insert		Layout Toolbar .....	161
Page Objects .....	360	LCD Screen Saver .....	207
Recipe Data Fields.....	434	LED Control Bits.....	429
Insert .....	247	LED Map	
Insert .....	360	All Panels .....	430
Insert .....	434	Eight User LEDs .....	430
Insert Menu .....	41	LED Map .....	430
Insert Page.....	182	LED Map .....	430
Installation .....	9	Length.....	166
Installing		Library .....	37
Network Cable.....	404	Light.....	126
New Panel Fonts.....	417	Line.....	146
Installing .....	404	Link.....	184
Installing .....	417	Lock Active Layers.....	41
Interfacing		Logout Timeout .....	244
Microsoft Excel .....	411	M	
Interfacing .....	411	Mailbox	

Structure .....	375	Multipage Organization .....	446
Mailbox .....	375	Multipage Recipe Support .....	445
Mailbox .....	467	Multipage Recipes	
Mailbox Programming .....	387	Recipe Menu .....	446
Major .....	165	Multipage Recipes .....	185
Make Same Size .....	26	Multipage Recipes .....	446
Make Same Size Both .....	27	Multiple Project Support .....	456
Make Same Size Height .....	27	Multiple-Protocol Configuration	
Make Same Size Width .....	27	Enabling .....	368
Margins .....	232	Multiple-Protocol Configuration .....	368
Maximize .....	342	N	
Maximum .....	160	Name .....	315, 325
Maximum Node Number .....	212	Needle .....	166
Memory Location		Needle Color .....	167
Project .....	270	Net Comm .....	213
Protocol .....	270	Network	
Memory Location .....	270	Comm Port .....	216
Memory Location .....	270	Running .....	416
Memory Type .....	199	Network .....	216
Memory Use .....	257	Network .....	400
Memory Used .....	360	Network .....	407
Message Data Fields .....	78	Network .....	416
Message Example .....	85	Network Cable	
Message Table .....	81	Installing .....	404
Message Toolbar .....	82	Network Cable .....	404
Messages		Network Configuration .....	211, 394, 412
Number .....	81	Network Example .....	412
Messages .....	81	Network Protocol .....	208
Messages tab .....	81	Network Selection .....	406
Meter Instrument .....	157	Network Setup .....	208
Meter Instrument Example .....	167	Network Types .....	397
Methods		New .....	328
Sampling .....	463	New Dictionary .....	289, 292
Methods .....	463	New File	
Microsoft Excel		Creating .....	359
Interfacing .....	411	New File .....	359
Microsoft Excel .....	411	New Group .....	289, 292
Minimize .....	342	New Insert .....	252
Minimum .....	81	New Panel Fonts	
Minor .....	165	Installing .....	417
Mirror .....	181	New Panel Fonts .....	417
Miscellaneous Panel Settings .....	359	New Report	
Mixed Multiple Servers Multiple Clients .....	396	Creating .....	421
Mode .....	204	New Report .....	421
Modem Commands .....	272	New Window .....	341
Modem Messages .....	272	Next Language .....	248
Modules .....	226	Next Page .....	183
Move .....	342	Next Record .....	293
Move Down .....	247	Node Number .....	214
Move Item Down .....	40	Nonprintable Characters .....	238
Move Item Up .....	40	Num Colors .....	315
Move Up .....	328	Num Comm Retries .....	216
Multipage Configuration .....	446	Number	

Languages.....	248	Panel .....	337
Messages .....	81	Panel .....	400
Parameter Sets .....	185	Panel .....	400
Number .....	81	Panel .....	405
Number .....	185	Panel .....	475
Number .....	248	Panel Font	
Number Redials .....	274	Compressing.....	419
Numeric ASCII Data Fields.....	44	Downloading.....	418
Numeric Data Field Example.....	72	Panel Font .....	27, 416
O		Panel Font .....	418
Objects .....	345	Panel Font .....	419
Objects Font.....	29	Panel Font Character Size.....	417
Objects Font Effects.....	30	Panel Font Name.....	28
Objects Font Font.....	29	Panel Font Size .....	28
Objects Font Sample .....	30	Panel IO .....	224
Objects Font Script .....	30	Panel Key Button.....	107
Objects Font Size .....	30	Panel Key Button Touch Cell Example.....	111
Objects Font Style.....	29	Panel Memory.....	197
Objects Libraries.....	472	Panel Menu	
Old Panel Models		Time Out .....	207
Recognition .....	195	Panel Menu .....	207
Old Panel Models.....	195	Panel Model .....	358
Only Show Active Layers.....	41	Panel Model tab .....	196
Only When Variable Not .....	256	Panel Node.....	215
Open.....	17	Panel Page Property .....	232
Operation mode.htm		Panel Selection.....	357
Switch.....	276	Panel Size .....	317
Operation mode.htm .....	276	Panel Startup.....	257
Options.....	266	Panel Status Area.....	426
Options Menu.....	301	Panel Status Word.....	426
Origin .....	164	Panel tab .....	316
Output .....	225	Panel Time .....	358
Output Reference .....	226	Panel Upload Protection .....	207
Oval.....	147	Panel via Ethernet.....	483
P		Parameter Sets	
PAGE.....	183, 242, 254, 370	Number.....	185
Page List .....	184	Parameter Sets .....	185
Page Menu .....	182	Parameters.....	377
Page Mode .....	187	Parity.....	228
Page Objects		Passthrough Settings.....	358
Inserting.....	360	Passthrough Status.....	56
Page Objects.....	360	Passthrough tab.....	203
Page Options .....	183	Password Automatic Login Example .....	243
Page Request Register.....	431	Password Example.....	244
Page Separator .....	238	Password Status .....	382
Page Size.....	229	Passwords .....	55, 240
Panel		Paste.....	186
Connecting.....	12, 400, 405	PC .....	12
Download .....	311	PC Printer Communications Port	
Panel.....	12	Pinout .....	401
Panel.....	179	PC Printer Communications Port.....	401
Panel.....	311	PC Printer Port Mode.....	60
Panel.....	337	PC Printer Port Module Number .....	59

Pick Panel .....	480	Project .....	460
Picture .....	320	Project File	
Ping .....	486	Creating .....	414, 415
Pinout		Saving .....	360
PC Printer Communications Port .....	401	Project File .....	360
PLC Communications Port .....	401	Project File .....	360
Pinout .....	401	Project File .....	414
Pinout .....	401	Project File .....	414
Placing		Project File .....	415
Fields .....	370	Project Memory .....	199
Placing .....	370	Project Menu .....	190
PLC .....	49, 152	Project Screen .....	352
PLC Communications Port		Project Upload .....	361
Pinout .....	401	Properties .....	180
PLC Communications Port .....	401	Protocol	
PLC Drivers		Memory Location .....	270
Changing .....	459	Protocol .....	229
PLC Drivers .....	459	Protocol .....	270
PLC Memory Area .....	465	Push Action .....	119, 125
PLC Port Mode .....	58	Push Button .....	117
PLC Port Module Number .....	59	Push Button Touch Cell Example .....	122
PLC Reference .....	94, 97	Q	
Port Settings .....	203	Quick Start Tutorial .....	3
Ports Available .....	267	Quick Start Tutorial Introduction .....	2
Position .....	315	R	
Precision .....	160	Range .....	69
Predefined Models .....	317	Range tab .....	68, 76
Pressure Indexed Field		RDA .....	423
Creating .....	65	RDA References .....	220
Pressure Indexed Field .....	65	Read Cycle .....	223, 375
Preview .....	79	Read Modes .....	223
Previous Page .....	183	Real Time Clock .....	426
Previous Record .....	293	Recent Files .....	290
Print .....	310	Recipe Action .....	53, 438
Print Preview .....	18	Recipe Backup .....	199
Print Setup .....	290	Recipe Configuration .....	184
Printer .....	227	Recipe Data Fields	
Printer Name .....	228	Inserting .....	434
Printer Properties .....	227	Recipe Data Fields .....	434
Printer Setup .....	226	Recipe Event Backup .....	57
Printer Setup Example .....	422	Recipe Examples .....	449
Printout Node .....	216	Recipe File Status .....	51, 436
Procedure		Recipe Item .....	187
Upgrade .....	364	Recipe Key .....	56, 440
Procedure .....	364	Recipe Menu	
Progress .....	427, 428, 429	Multipage Recipes .....	446
Project		Recipe Menu .....	172
Configuring .....	460	Recipe Menu .....	446
Creating .....	359	Recipe Menu Example .....	444
Memory Location .....	270	Recipe Menu Field	
Project .....	270	Creating .....	443
Project .....	346	Recipe Menu Field .....	443
Project .....	359	Recipe Menu Keyboard Macros .....	445

Recipe Menu Support Fields.....	443	Right-Click Menus.....	354
Recipe Name Example.....	442	Rim .....	163
Recipe Names .....	442	ROM File	
Recipe Page		Export.....	311
Selection.....	55, 440	ROM File.....	311
Recipe Page.....	55	Rotation .....	164
Recipe Page.....	440	Row.....	234, 236
Recipe Parameter Set Selection .....	52, 437	Row Menu .....	301
Recipe Parameter Sets		RS232	
Configuring .....	434	RS485.....	403
Recipe Parameter Sets.....	187	TSI01 Bus.....	402
Recipe Parameter Sets.....	434	RS232 .....	402
Recipe Size.....	199	RS232 .....	403
Recipe Status.....	377	RS232 Cable	
Recipe Upload.....	270	TSI01 Bus.....	402
Recipe Values .....	186	RS232 Cable .....	402
Recipes. 61, 407, 433, 434, 435, 441, 445, 447, 448		RS485	
Recognition		RS232.....	403
Old Panel Models .....	195	RS485 .....	210, 397
Recognition .....	195	RS485 .....	403
Record Menu.....	292	RS485 Cable	
Rectangle .....	147, 301	TSI02 Bus.....	403
Redo .....	24, 291	RS485 Cable .....	403
Reference .....	160	RS485 Network .....	400
Refresh .....	193	Running	
Refresh Database .....	249	Network.....	416
Remote Hardware .....	204	Running .....	416
Remote Passthrough.....	276	S	
Remove .....	231	S0 Link Status Monitor Flag.....	427
Remove All .....	232	S1 Data Entry Active .....	427
Replace.....	291	S12 Recipe .....	428
Replace Images .....	339	S13 Recipe Upload .....	428
Report Header Footer.....	421	S14 Recipe Download .....	429
Report List .....	230	S15 Recipe File Status .....	429
Report on Panel Printer.....	226	S2 Printing .....	427
Report Printout		S3 Printer Status .....	427
Triggering.....	421	S4 Date .....	427
Report Printout.....	421	S5 Attempt	
Reports		Access Protected Function .....	428
Bug .....	13	S5 Attempt.....	428
Reports .....	13	S6 Battery Low .....	428
Reports .....	240	S7 Alarm Active .....	428
Reports .....	420	S8 Unacknowledged Alarm Active .....	428
Request Data Entry Mode.....	381	Samples	
Request Masked Data Entry Mode .....	381	Methods.....	463
Reserved Data Area .....	407	tab.....	255
Reset.....	181	Samples.....	152
Reset Delete .....	326	Samples.....	255
Restore .....	341	Samples.....	463
Retries		Save As.....	17
Communications Number.....	269	Saving	
Retries .....	269	Font .....	305
		Project File .....	360



Saving .....	298	Single Server Multiple Clients.....	395
Saving .....	305	Size	
Saving .....	360	Fit .....	181
Scaling		Size .....	165
Example.....	71	Size .....	181
tab .....	70, 76	Smooth.....	181
Scaling .....	70	Snap	
Scaling .....	71	Grid .....	335
Scaling .....	71	Snap .....	335
Scaling .....	76	SNTP Protocol .....	482
Scaling .....	160	Software Installation .....	10
Scroll .....	184	Software License .....	14
Scroll Direction.....	152	Special Characters .....	175
Second Client.....	415	Special Formats .....	238
Select All.....	25	Special Pages .....	187
Select Controller .....	193	SSFDC	
Select Language .....	84	Download .....	263
Selecting		SSFDC .....	263
Ethernet Communication.....	479	SSFDC .....	317
Font.....	360	SSFDC Error Codes	
Selecting.....	360	Displaying .....	264
Selecting.....	479	SSFDC Error Codes.....	264
Selection		Stage Numeric Data Field	
Recipe Page .....	55, 440	Creating .....	64
Selection.....	55	Stage Numeric Data Field.....	64
Selection.....	440	Start.....	164
Selector Switch .....	130	Start Program After Download .....	269
Selector Switch Touch Cell Example .....	134	Start Recipe Download .....	378
Serial ports .....	267	Start Recipe Upload .....	378
Servers .....	390, 414	Start Report Printout .....	385
Set As Default.....	247	Start Screen Saver.....	386
Set As Recipe Name .....	186	Start Transfer .....	383
Set Current Language .....	386	Start Transfer No Confirmation.....	382
Set Parameter Set Number.....	379	Static Attributes .....	86
Set Recipe Transfer Priority.....	380	Status Bar.....	294
Set RTC.....	384	Status Word .....	376
Setting		Stop.....	277
Up .....	412, 421, 459	Stop Bits .....	194
Setting .....	412	Stop Report Printout .....	385
Setting .....	421	Stop Sampling.....	256
Setting .....	459	Stop Screen Saver .....	386
Settings List .....	198	Structure	
Setup .....	356, 357	Mailbox .....	375
Shapes .....	146	Structure.....	375
Sharpen .....	181	Style .....	86
Show .....	41	Support	
Show Grid .....	335	64K Colors .....	487
Show Tooltips .....	325	Support.....	487
Signed Unsigned .....	48	Swap Protocols .....	338
Simple Data Fields .....	361	Switch	
Simple Recipe Example.....	449	Configuration mode .....	276
Simple Shapes.....	469	Operation mode.htm.....	276
Simple Touch Cells.....	362	Switch .....	276

Switch .....	276	Time Out.....	207
Symbol Browser.....	304	Time Out.....	207
System.....	188	Time Scheduler Triggers .....	257
System Requirements.....	10	Time Update .....	427
T		Title.....	155
Tab		Title Color.....	162
Sampling.....	255	Title Font .....	162
Scaling .....	70, 76	Title X.....	162
Tab .....	70	Title Y.....	162
Tab .....	76	Toolbars .....	350
Tab .....	255	Tools .....	327
Tag Dictionary .....	455, 459	Tools Menu.....	278
Tag Editor .....	456	Tooltips.....	355
Tag Editor Synchronization .....	457	Touch Cell Keyboard Macro Editor Example .....	105
Tag Example .....	459	Touch Cell Preview Window.....	104
Tag Groups .....	457	Touch Cells.....	104
Tag Validation		Touch Screen .....	199
Testing.....	461	Transfer.....	268
Tag Validation .....	458	Transfer Advanced.....	270
Tag Validation .....	461	Transfer Settings.....	355
Tags		Transfers Menu.....	261
Connect.....	338	Trend Buffer	
Tags.....	338	Configuring .....	462
Tags.....	454	Trend Buffer .....	250, 462
Tags UniNETand PLC Networks .....	455	Trend Buffer .....	462
Tail.....	166	Trend Buffer memory .....	199
TCM10 Board.....	398	Trend Buffers on PLC .....	465
Technical Support .....	13	Trend Limitations .....	468
Temperature Indexed Field		Trend Macros.....	467
Creating .....	64	Trend Printing.....	467
Temperature Indexed Field .....	64	Trend Time Field .....	168
Testing		Trend Time Field Example .....	171
Tag Validation .....	461	Trend Window .....	147
Testing .....	461	Trend Window Example.....	156
Text .....	42	Trend Window Limitations.....	148
Text Entry .....	336	Trends .....	461
Text tab .....	68, 75, 80	Trigger Properties .....	240
Thickness .....	166	Trigger Type .....	240
Ticks.....	165	Triggers	
Tile Horizontally.....	341	Report Printout .....	421
Tile Vertically .....	341	Triggers.....	239
Time .....	189, 240	Triggers.....	421
Time Data Field .....	101	TSI01 .....	403
Time Data Field Example .....	102	TSI01 Bus	
Time Format.....	200	RS232.....	402
Time Indexed Field		RS232 Cable.....	402
Creating .....	66	TSI01 Bus .....	402
Time Indexed Field .....	66	TSI01 Bus .....	402
Time Out		TSI02 Bus	
Data Entry.....	207	RS485 Cable.....	403
Field Selection.....	207	TSI02 Bus .....	403
Panel Menu.....	207	TSI02 Bus Terminal .....	404
Time Out.....	207		

Type .....	150	Creating .....	321
U		Value Objects.....	321
Undo.....	24, 290	Variable .....	50
Uni7Seg Font .....	418	Version.....	271
UniComic Font.....	417	Vertical Align .....	321
UniNET Networks		Vertical Position .....	316
Configuring .....	372	Video Input Option .....	490
UniNET Networks .....	372	View Menu .....	30
UniNET Networks .....	389	W	
UniNET OPC Server.....	408, 411	Welcome .....	vii
UniNET TCPIP.....	213	Width .....	156
UniNET Technical Data .....	393	Width Menu .....	301
UniOP SSFDC Error Codes.....	264	Workspace .....	342
Up		Wrap Lines.....	237
Setting.....	412, 421, 459	X	
Update Cycle.....	226	X Axis.....	151
Update Firmware .....	269	X Axis Maximum .....	153
Update PLC References .....	199	X Axis Minimum.....	153
Upgrade		X Cursor .....	153
Procedure.....	364	X Grid .....	156
Upgrade.....	364	X Grid Color .....	156
Upload		X Grid Marks.....	156
Downloading .....	372	Y	
Upload.....	263	Y Axis.....	149
Upload.....	372	Y Axis Maximum .....	151
Use Modem.....	268	Y Axis Minimum.....	150
Use Tags .....	460	Y Cursor .....	150
Using Tags .....	458	Y Grid .....	156
Using UniDataExchanger		Y Grid Color.....	156
Access Information.....	483	Y Grid Marks.....	156
Using UniDataExchanger .....	483	Z	
V		Zoom In .....	30
Validate Project Data .....	338	Zoom Out.....	31
Value Objects			